

See discussions, stats, and author profiles for this publication at: <https://www.researchgate.net/publication/268814067>

Advanced Lightweight Aircraft Design Configurations for Green Operations

Conference Paper · November 2014

DOI: 10.13140/2.1.4231.8405

CITATIONS

9

READS

3,451

2 authors:



Matthew Marino
RMIT University

59 PUBLICATIONS 357 CITATIONS

[SEE PROFILE](#)



Roberto Sabatini
RMIT University

414 PUBLICATIONS 3,503 CITATIONS

[SEE PROFILE](#)

Some of the authors of this publication are also working on these related projects:



Intelligent and Autonomous Navigation and Guidance Systems [View project](#)



Turbulence Mitigation [View project](#)

Advanced Lightweight Aircraft Design Configurations for Green Operations

Matthew Marino¹, Roberto Sabatini¹

¹ RMIT, Melbourne, Victoria, Australia

Abstract

This paper gives a review of advanced aircraft configurations which are currently under research and development. New aircraft configurations are needed to provide significant reductions in aircraft emissions to achieve the ambitious 50% carbon reduction target by 2050. Although current green technologies provide small improvements to aircraft efficiency and fuel burn, studies into the Blended Wing Body, Box Wing, and morphing aircraft technologies have shown to be feasible and highly instrumental in lighter and more efficient aircraft designs. These designs are estimated to reduce carbon emission by up to 30%. These aircraft designs are not without operation, design and social challenges however they provide hope in achieving a sustainable aviation future and maybe one without reliance on fossil fuels.

Keywords

Aerodynamics, aircraft configurations, future aircraft, future air travel, aircraft concepts, aircraft operations,

1. Introduction

Green aviation operations are a primary focus to many local and international industries. The increasing price of fossil fuel, various carbon taxes/trading schemes and contributions to global warming are concerns that need to be addressed for a sustainable aviation future (Maurice & Lee, 2009). The international aviation operation contributes 2-3% to the global warming phenomena (Lee et al., 2009). If aviation remains on its current path with no significant operational changes, its contribution to global warming is predicted to increase to 10-15% by 2050 due to the forecasted demand (Maurice & Lee, 2009). Aircraft and airport emissions, and their contribution to global warming, are well known with significant investment into research and development to reduce aviation's carbon footprint and also provide a foundation for a sustainable aviation industry (Lee et al., 2009). The International Civil Aviation Organization (ICAO) has identified various requirements to evolve the aviation operation to a more efficient model and yield significantly greater efficiencies to reduce aviation's emissions by 50% by 2050 (Maurice & Lee, 2009). One of these recommendations related to the operation of new aircraft design configurations in the near future.

The introduction of new and efficient aircraft (Boeing 787 Dreamliner and the Airbus A380) have shown operational efficiency improvements with extensive use of new materials applied to various parts of the aircraft structure (Cikovic & Damarodis, 2012; Kechidi, 2013). The introduction of carbon and hybrid materials have allowed for lighter aircraft structures while improving structure strength, life-cycle and safety requirements (Immarigeon et al., 1995). Less aircraft weight translates into less lift and drag production in flight. Lift and drag savings are highly correlated to the amount of thrust needed resulting in less thrust and less fuel burn. Weight savings of this nature can only facilitate emission reductions up to a certain point. Even aerodynamic advancements on conventional aircraft can only offer small efficiency improvements. New aircraft configurations have shown potential in significant emission reductions by exploiting designs that significantly increase lift/drag ratios and allow for lighter aircraft structures (Ordoukhanian & Madni, 2014). Although novel aircraft configurations require much research and development, the realization of these concepts are forecasted to significantly reduce emissions and grow confidence in achieving a 50% reduction in carbon based emissions (Hileman, Spakovszky, Dreila, Sargeant, & Jones, 2010).

2. Aircraft fuel consumption

The calculation of fuel consumption can be performed for various phases in flight however the majority of fuel is consumed in the take-off and cruise flight phase. This section will focus on the cruise flight phase and requires certain assumptions to model fuel consumption.

Forces acting on an aircraft can be represented by the free body diagram in figure 1.

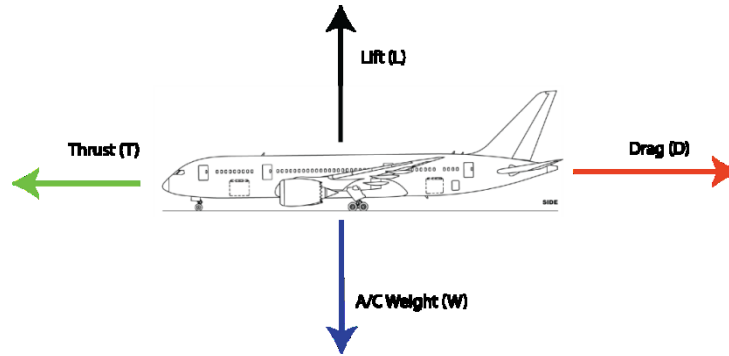

In the cruise phase the aircraft is assumed to be at a steady level attitude with constant velocity and no deviation of altitude. Under this scenario the weight of the aircraft is completely overcome by lift to which we can state $Lift = Weight$. Likewise constant velocity implies that the drag of the aircraft is completely overcome by thrust produced by the engines allowing $Thrust = Drag$. The weight of an aircraft is also assumed to change over the course of the flight as fuel is constantly used by the engines. As such the weight of an aircraft is different at the beginning and the end of its flight. It is logical in this sense to quantify an initial ($W_{initial}$) and final (W_{final}) aircraft weight and as a definable quantity of fuel can be simply calculated. This also assumes that fuel is the only material subtracted in its operation.

The calculation of aircraft fuel consumption can be performed by using the Breguet equation (equation 1) (Bréguet, 1920). The Breguet equation models the range of any given aircraft and takes into account the aerodynamics, propulsion and structural weight.

$$R = \frac{h}{g} \frac{L}{D} \eta \log \frac{W_{initial}}{W_{final}} \quad (1)$$

Where “ L ” is the lift force, “ D ” is drag force, “ h ” is the fuel energy per unit mass, “ g ” is the force due to gravity and “ η ” is the overall propulsive efficiency.

Although the calculation of range is of value, the Breguet equation can be transformed into another form in order to calculate Specific Fuel Consumption (SFC) measured in kg/s/N, a more relevant variable that described the amount of fuel consumed by the aircraft engines and directly correlates to the overall efficiency of the aircraft.

$$SFC = \frac{v(L/D)}{g.R} \log \left(\frac{W_{initial}}{W_{final}} \right) \quad (2)$$

To demonstrate this further we study a long-haul flight from Melbourne to Shanghai on an aircraft similar to the Airbus A330-200 to calculate the reduction in SFC. Table 1 summarizes the data use for the case study.

Assumptions	
Aircraft Similarity	A330 – 200
L/D ratio	20
Passengers	241 pax
Weight per passenger (Human + 20kg luggage +10kg carry on)	105 kg
W_{empty}	119,600 kg
Flight Velocity	220 ms^{-1}
Fuel Efficiency per seat	0.0332 L/Km
Gravity constant	9.2 Nm^2kg^{-1}
Range (Melbourne to Shanghai)	8050 km

Table 1: Melbourne to Shanghai case study trip data

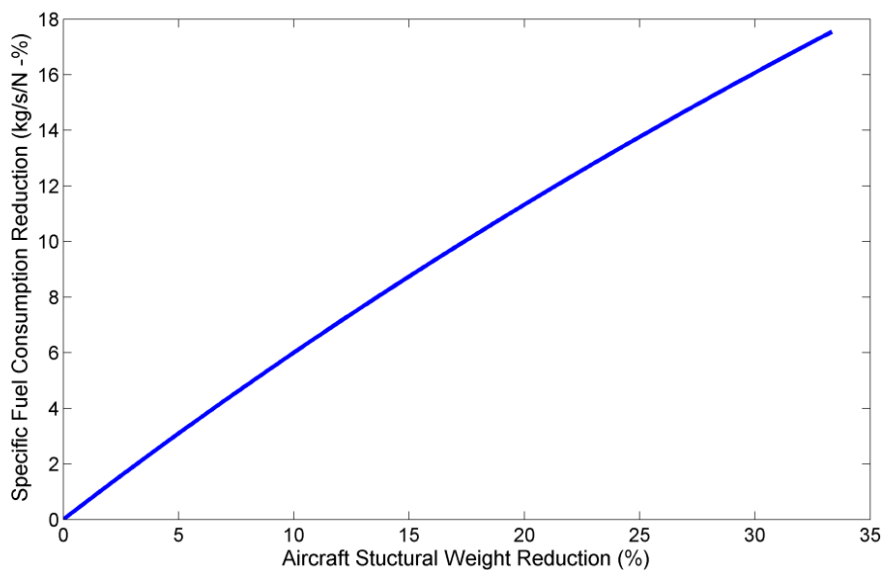

Figure 1: Relationship between aircraft structural weight reduction and SFC

It is clear that reducing the structural weight of an aircraft has significant benefits to its operational efficiency. Modern day aircraft, such as the Boeing 787, are 20% lighter to similar aircraft types due to the extensive use of fibre-reinforced composites. Weight savings of this magnitude results in efficiency increases in the order of 10-12%. Although further improvements can be made in the current aircraft configuration, new aircraft configurations offer higher operational efficiencies due to the nature of their design, structure and thrust requirements.

3. Blended Wing Body (BWB) Transport Aircraft

The development of the BWB commenced in 1994 as a joint venture between NASA and McDonnell Douglas to evaluate if the design proved to be a more efficient means of high-capacity long-haul transport aircraft (Liebeck, 2004). The BWB aircraft is significantly different from common transport aircraft types. The design approach is taken from a "Flying Wing" concept where the majority of the aircraft surface is used to produce lift as opposed to the current transport aircraft where the pressurized cabin only exists as a chamber to hold cargo.



Figure 2: The Blended Wing Body operational concept (left) and Boeing X48C BWB prototype (right) (Vicroy, 2011)

The BWB is unique in the fact that fuselage is an integration platform for wing, control surfaces and engines inlets. The design is conceptualized to carry approximately 800 passengers within an operational radius of 7000nm at a cruise velocity of Mach 0.85(Liebeck, 2004).

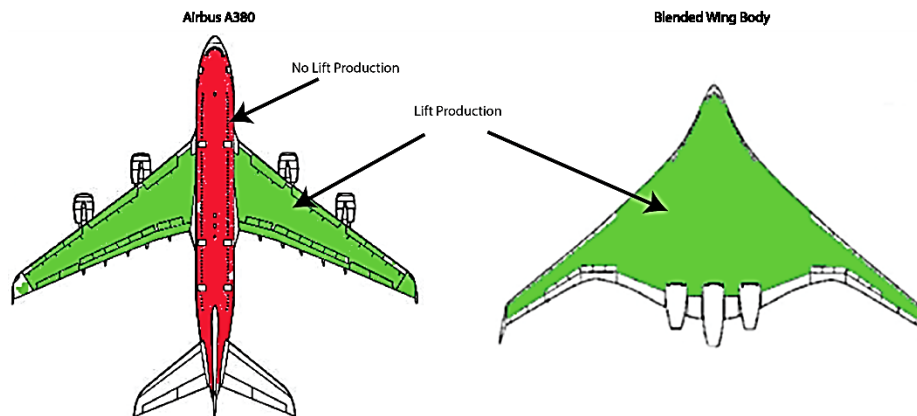

Figure 3: Lift production comparison between Airbus A380 and Blended Wing Body

Due to the shape and configuration of the BWB, the aircraft was calculated to have an advantageous operational efficiency. Preliminary findings approximated 27% less fuel burn, 15% weight saving, 12% lower empty weight, 27% less total thrust required and 20% higher lift to drag ratio relative to current commercial aircraft of similar size (Liebeck, 2004). Due to the configuration of the design, more material can be distributed further away from the aircraft centroid increasing the strength of the BWB structure. As such, less material is needed to design the BWB in order for it to meet certification requirements. The design of the BWB also suggests significant reductions in aircraft ground noise as the engines are situated above rear section of the BWB which allows the fuselage to act as a reflective sound barrier to propagate the majority of noise towards the sky(Ko et al., 2003).

The BWB design does not come without design and operational challenges. One of the more challenging aspects is its non-circular fuselage structure which requires extensive structural reinforcement to maintain pressurizations(Roman, Allen, & Liebeck, 2000). A non-issue with conventional aircraft due to the structural efficiency inherent in the tubular cabin design. There are also social issues associated with its design such as the significant reduction in the amount of passenger windows and arena style seating(Hall, Mayer, Wuggetzer, & Childs, 2013). Although such issues are taken into consideration in the BWB development process, the revolutionary aircraft design is a key technology which will significantly contribute to the 50% reduction of carbon emissions by 2050.

4. The Box Wing Aircraft

The box wing design commonly utilized two wings that are joined together at the wing tips. The forward wing sweeps backward to join the rear wing which is swept forward. This concept was first patented in 1974 with application on military aircraft ("Boxplane wing and aircraft," 1974). Patents regarding Commercial box wing aircraft followed however its design was never introduced into commercial airliners due to the strong focus on monoplane aircraft designs (Wolkovitch, 1982). The benefits of the Box wing design have been mathematically and experimentally determined to be (Wolkovitch, 1986):

- Light weight
- High stiffness
- Low induced drag
- Good transonic lift distribution
- High C_{Lmax}
- Reduced wetted area and parasite drag
- Direct lift control capability
- Good stability and control.

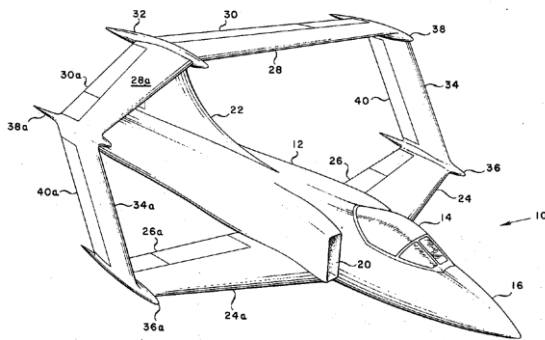

Figure 4: The Box Wing Aircraft concept – left ("Boxplane wing and aircraft," 1974) & Box Wing Airliner - right (Picture by Nick Kaloterakis)

The Box Wing design offers greater lift-to-drag ratios due to the forward and aft wings which joined together using enlarged wing tips to create a closed box structure. This configuration significantly reduces the wing tip vortex effect caused by the high and low pressure regions on the lower and upper surfaces of the wing respectively which produce 4 distinct vortices. This aerodynamic effect is commonly known as induced drag and is responsible for the majority of drag produced by the aircraft (Kroo, Smith, & Gallman, 1991). The Box Wing aircraft configuration reduces the amount of induced drag produced as the closed wing structure restricts tip vortex formation. This was found, through wing tip design studies, that the Box Wing configuration was experimentally determined to have the greatest Oswald (lift/drag) efficiency compared to monoplane configurations with various wing tip designs (Lowson, 1990). By increasing the Oswald efficiency factor the induced drag of the wing reduces. This can be demonstrated through the induced drag equation where the efficiency factor resides as one of the denominator terms (equation 2).

$$C_{Di} = \frac{C_L^2}{\pi e AR} \quad (2)$$

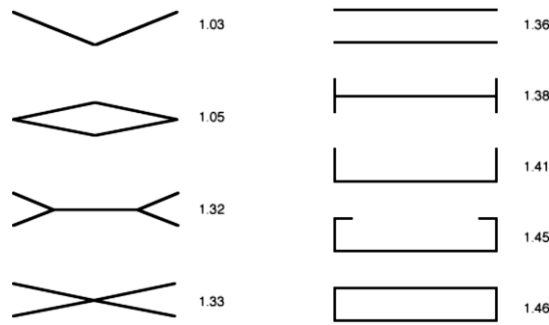

Figure 5: Front view wing configurations and associated efficiency factors (Lowson, 1990).

Studies have found that an optimized Box Wing commercial aircraft could offer a 30% reduction in drag to which fuel usage, lift-to-drag ratio, range and endurance will improve significantly (Kroo, 2005). The expanded wing volume also provides a means of storing more fuel. This will provide an endurance improvement and operational advantage as the aircraft could fly around the globe without the need of refuelling (Wolkovitch, 1986). The wing design offers significant weight reduction as the nature of the configuration situates material away from the aircraft centroid and increases structural efficiency and resistance to bending (Kroo, 1984). Like the BWB concept, increases in structural efficiency permits less material in manufacture and hence less weight. This is represented graphically in figure 6 where the relative weight of the lifting surfaces (the wing) is compared to conventional aircraft with varying span and sweep angle.

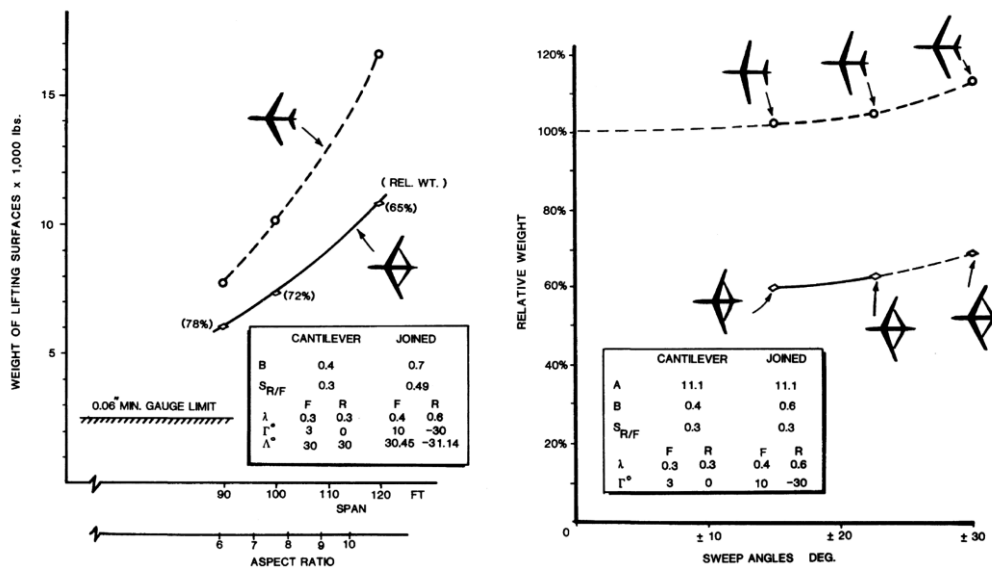

Figure 6: The change in relative wing weight due to changes in span and sweep (Wolkovitch, 1986)

The Box Wing aircraft configuration inherits advantageous weight and performance characteristics over conventional aircraft types. Although the Box-Wing wings looks significantly different from conventional aircraft, the main cabin and associated airframe systems will not need major redesign. This will appeal to the majority customer base as the flight experience on-board a Box Wing airliner will be familiar to the common passenger.

5. Morphing wing Aircraft

Morphing wing technology is a concept which allows the wings to actively change shape in flight. This can be done through mechanical or organic means. For instance, a birds wings can actively change

shape due to the organic nature of its muscles and skeletal structure while the F-111 actively change its wing shape by altering sweep angle. The current standing organization review of morphing wings can be visualized in figure 7.

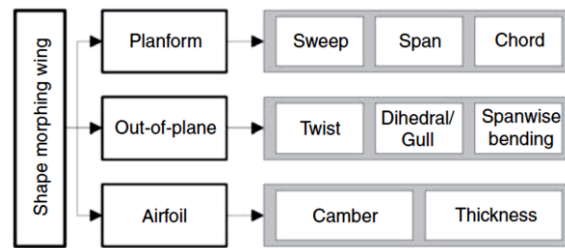

Figure 7: Morphing wing research streams in an organization view (Barbarino, Bilgen, Ajaj, Friswell, & Inman, 2011).

The morphing wing aircraft concept is a relatively old design with first inception in the Wright flyer in 1909. The wings were allowed to twist under the load of various cables running through a complex pulley system throughout the aircraft. This of course was only allowed due to the flexible nature of the wing itself. As time progresses aircraft wings became solid structures which allowed for greater strength and flight performance. The morphing concept introduced again on the Bell X-5 by introducing variable sweeping wings which could be actuated in flight to change the aircrafts configuration. This was later applied to military aircraft such as the F-4 Phantom, F111 Aardvark and F-14 Tomcat. The wing morphing capability was advantageous as it allowed a full forward sweep configuration for improved slow speed flight dynamics while the sweep back configuration allowed for improved high speed flight dynamics. The concept of variable configurations is of interest to the commercial aviation industry as it allows greater operational efficiencies due to the idea that the wing structure can change to suit the flight phase itself. The spider plot in figure 8 displays the operational, aerodynamic and geometric advantages of different wing configurations. The outer circle of the plot represents the best case performance measure.

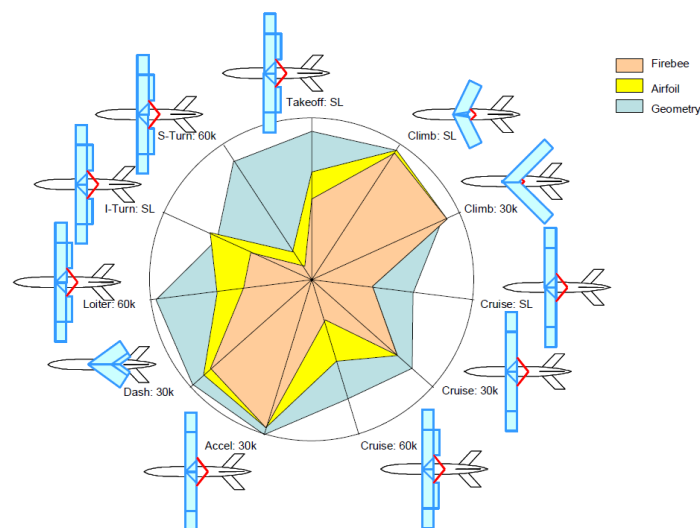

Figure 8: Influence of wing configuration changes on an aircraft (Joshi, Tidwell, Crossley, & Ramakrishnan, 2004)

There has also been scope to improve or replace the conventional high lift devices by using variable camber morphing technology in which will reduce structural weight and aerodynamic noise (Van Dam, 2002). This morphing technology facilitates the active and controlled change of air foil shape. This is particularly important as it allows for a thicker and more highly cambered airfoil for slow flight phases with the capability to reconfigure into a thin straight airfoil for high-velocity/supersonic flight operations (Joshi et al., 2004). There are also concepts of wing twist morphing which allows for greater aerodynamic efficiency over the conventional aileron design and also allows variable airfoil

geometry over the span of the wing (Joshi et al., 2004). This type of morphing is enabled due to the advancements in material sciences. The use of organic materials and Smart Material Alloys provide a controllable means of contracting or retracting a material (Sofla, Meguid, Tan, & Yeo, 2010). In other words the materials surface area can be increased or decreased in a controlled manner through electronic means. This is supported by novel internal structures which allow bending in the required direction while maintaining wing strength and rigidity.

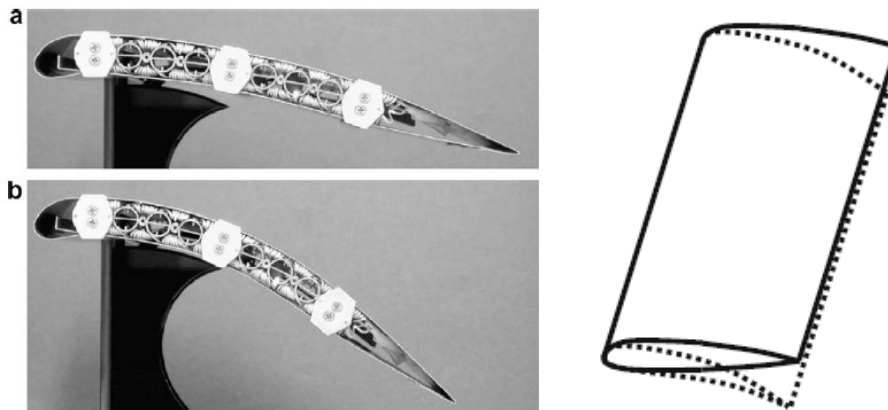

Figure 9: Smart Memory Alloy wing morphing (camber change)

Morphing aircraft structures provide a platform for engineering imagination. Although current research is mainly focus on wing morphing technology, there is scope to expand the concept to various parts of the airframe and provide lighter and more efficient aerodynamic structures which will contribute to reducing aircraft emissions.

6. Conclusion

The customer demand for air travel is constantly increasing and with it aviation's contributions to carbon based emissions. Current aircraft technologies are proving effective in reducing aircraft emissions however new materials, efficient propulsion and green operations can only reduce emission up to a certain degree. To meet the 2050 goal of 50% less carbon emission, new and innovative aircraft designs need to be introduced in air travel operations. Advanced aircraft configurations have shown feasibility and capability to substantially reduce carbon emissions and change the way we fly. The aircraft configurations presented here provide a brief conceptual view of the key technologies that are currently under research and development however the implementation of these aircraft configurations may still be decades away.

7. References

- Barbarino, S., Bilgen, O., Ajaj, R. M., Friswell, M. I., & Inman, D. J. (2011). A review of morphing aircraft. *Journal of Intelligent Material Systems and Structures*, 22(9), 823-877.
- Boxplane wing and aircraft. (1974).
- Bréguet, L. (1920). *Calcul du poids de combustible consommé par un avion en vol ascendant*: Gauthier-Villars.
- Cikovic, A., & Damarodis, T. (2012). The Boeing 787'S role in new sustainability in the commercial aircraft industry. *University of Pittsburgh*. oO Online verfügbar unter [http://www. google. de/url](http://www.google.de/url).
- Hall, A., Mayer, T., Wuggetzer, I., & Childs, P. (2013). Future aircraft cabins and design thinking: optimisation vs. win-win scenarios. *Propulsion and Power Research*, 2(2), 85-95.
- Hileman, J., Spakovszky, Z., Drela, M., Sargeant, M., & Jones, A. (2010). Airframe design for silent fuel-efficient aircraft. *Journal of aircraft*, 47(3), 956-969.
- Immarigeon, J., Holt, R., Koul, A., Zhao, L., Wallace, W., & Beddoes, J. (1995). Lightweight materials for aircraft applications. *Materials Characterization*, 35(1), 41-67.

- Joshi, S. P., Tidwell, Z., Crossley, W. A., & Ramakrishnan, S. (2004). Comparison of morphing wing strategies based upon aircraft performance impacts. *sea*, 2, 32.
- Kechidi, M. (2013). From 'aircraft manufacturer' to 'architect-integrator': Airbus's industrial organisation model. *International Journal of Technology and Globalisation*, 7(1), 8-22.
- Ko, A., Leifsson, L. T., Schetz, J., Mason, W., Grossman, B., & Haftka, R. T. (2003). MDO of a blended-wing-body transport aircraft with distributed propulsion. *AIAA Paper*, 6732, 2003.
- Kroo, I. (1984). A general approach to multiple lifting surface design and analysis. *AIAA Paper*, 84-2507.
- Kroo, I. (2005). Nonplanar wing concepts for increased aircraft efficiency. *VKI lecture series on innovative configurations and advanced concepts for future civil aircraft*.
- Kroo, I., Smith, S., & Gallman, J. (1991). Aerodynamic and structural studies of joined-wing aircraft. *Journal of aircraft*, 28(1), 74-81.
- Lee, D. S., Fahey, D. W., Forster, P. M., Newton, P. J., Wit, R. C., Lim, L. L., . . . Sausen, R. (2009). Aviation and global climate change in the 21st century. *Atmospheric Environment*, 43(22), 3520-3537.
- Liebeck, R. H. (2004). Design of the blended wing body subsonic transport. *Journal of aircraft*, 41(1), 10-25.
- Lowson, M. V. (1990). Minimum induced drag for wings with spanwise camber. *Journal of aircraft*, 27(7), 627-631.
- Maurice, L., & Lee, D. (2009). Assessing Current Scientific Knowledge, Uncertainties and Gaps in Quantifying Climate Change, Noise and Air Quality Aviation Impacts, final report of the International Civil Aviation Organization (ICAO) Committee on Aviation and Environmental Protection (CAEP) Workshop. *Washington DC and Manchester: US Federal Aviation Administration and Manchester Metropolitan University*.
- Ordoukhanian, E., & Madni, A. M. (2014). Blended Wing Body Architecting and Design: Current Status and Future Prospects. *Procedia Computer Science*, 28, 619-625.
- Roman, D., Allen, J., & Liebeck, R. (2000). Aerodynamic design challenges of the blended-wing-body subsonic transport. *AIAA Paper*, 4335, 2000.
- Sofla, A., Meguid, S., Tan, K., & Yeo, W. (2010). Shape morphing of aircraft wing: Status and challenges. *Materials & Design*, 31(3), 1284-1292.
- Van Dam, C. (2002). The aerodynamic design of multi-element high-lift systems for transport airplanes. *Progress in Aerospace Sciences*, 38(2), 101-144.
- Vicroy, D. (2011). X-48B Blended Wing Body Ground to Flight Correlation Update.
- Wolkovitch, J. (1982). Joined wing aircraft: Google Patents.
- Wolkovitch, J. (1986). The joined wing-An overview. *Journal of aircraft*, 23(3), 161-178.