

Ship Energy Efficiency Measures

Status and Guidance



Our Mission

The mission of ABS is to serve the public interest as well as the needs of our clients by promoting the security of life and property and preserving the natural environment.

Quality & Environmental Policy

It is the policy of ABS to be responsive to the individual and collective needs of our clients as well as those of the public at large, to provide quality services in support of our mission, and to provide our services consistent with international standards developed to avoid, reduce or control pollution to the environment.

All of our client commitments, supporting actions, and services delivered must be recognized as expressions of quality. We pledge to monitor our performance as an ongoing activity and to strive for continuous improvement.

We commit to operate consistent with applicable environmental legislation and regulations and to provide a framework for establishing and reviewing environmental objectives and targets.



Ship Energy Efficiency Measures Advisory

Introduction	2
Fuel Savings Estimates.....	3
Fuel Efficiency Incentives.....	3
Section 1: Hull Form Optimization	4
Introduction.....	4
Optimizing Ship Particulars.....	4
Minimizing Hull Resistance and Increasing Propulsion Efficiency.....	7
Added Resistance Due to Waves and Wind.....	13
The Influence of IMO’s EEDI on Ship Design.....	15
Section 2: Energy-saving Devices	17
Introduction.....	17
Propulsion Improving Devices (PIDs).....	17
Skin Friction Reduction.....	24
Renewable Energy.....	26
Compatibility.....	29
Section 3: Structural Optimization and Light Weight Construction	32
Introduction.....	32
Use of Higher Strength Steel (HTS).....	32
Weight Savings from Use of HTS.....	33
Potential Impact of HTS on Payload.....	34
Potential Impact of HTS on Fuel Consumption.....	34
Composites and Other Nonferrous Materials.....	34
Section 4: Machinery Technology	35
Introduction.....	35
Prime Movers – Main and Auxiliary Engines.....	35
Waste Heat Recovery.....	45
Auxiliary Equipment.....	49
Section 5: Fuel Efficiency of Ships in Service	53
Introduction.....	53
Ship Operation: Voyage Performance Management.....	53
Hull and Propeller Condition Management.....	61
Ship System Management.....	67
Overall Energy Efficiency Management.....	69
References	72

Introduction

This Advisory has been compiled to provide useful information on the status and the current state of ship energy efficiency measures. It provides guidance to owners and operators on the wide range of options being promoted to improve vessel efficiency, reduce fuel consumption and lower emissions. Included is background information, descriptions of the technologies, explanations of key issues, general pros/cons of each measure and limits of applicability or effectiveness, as well as practical issues related to implementation.

The material is presented in five sections: Sections 1 and 3 address challenges for new vessel construction; Sections 2, 4 and 5 cover both new and existing vessels.

Section 1: Hull Form Optimization

This section addresses issues related to the basic hull form design including selecting proper proportions, reducing resistance by optimizing the hull form and appendage design, and assessing the impact on resistance of waves and wind. There is also a discussion of how the IMO Energy Efficiency Design Index (EEDI) influences ship design and efficiency.

Section 2: Energy-saving Devices

This section covers devices used to correct or improve the efficiency of propellers as well as

developing technologies aimed at reducing the hull frictional resistance or using renewable energy sources (such as solar and wind energy).

Section 3: Structural Optimization and Light Weight Construction

This section addresses the impact of the use of high strength steel on lightship weight and energy consumption.

Section 4: Machinery Technology

This section looks at the efficiency gains that are possible in the design and operation of the ship's machinery and systems. It covers main and auxiliary diesel engines, waste heat recovery and other auxiliary equipment.

Section 5: Fuel Efficiency of Ships in Service

The final section addresses operational measures that can reduce fuel consumption. These include voyage performance management, hull and propeller condition management, optimum ship systems operation and overall energy efficiency management.

As noted by IMO “the best package of measures for a ship to improve efficiency differs to a great extent depending upon ship type, cargoes, routes and other factors...” (MEPC.1/683). The difficulty is in determining which ones are most appropriate for a particular vessel and service.



ABS has developed this Advisory to assist owners/operators with selecting appropriate measures for their vessels which is a key input to developing Ship Energy Efficiency Management Plans (SEEMP) for each vessel in accordance with the IMO's mandatory requirement.

Fuel Savings Estimates

The fuel savings estimates in this Advisory are based on values derived from vendor and manufacturer claims, industry reports, practical operating experience and ABS engineering review. The data have been combined in an objective way to reflect, as best as possible, the realistic savings in fuel consumption that could be expected in practice. Still the range of savings for some efficiency measures is large and this can reflect uncertainty in the expected performance.

The fuel or energy savings are presented in one of several ways depending on the efficiency measure:

- A reduction in specific fuel oil consumption (SFOC). This is used for measures directly related to diesel engine consumption, making the engine and/or its systems operate more efficiently.
- A reduction in propulsion fuel consumption. This is related to main engine energy use, power delivered to the propeller and overall hull resistance.
- A reduction in overall vessel fuel consumption. This includes fuel used by auxiliary engines and is related to the total fuel cost for the vessel.

When assessing the total possible savings for a vessel, it is important to keep in mind the basis for the savings for each different energy-savings measure. The application of one measure may exclude or reduce the benefit of another measure; energy-saving estimates from different measures are not cumulative.

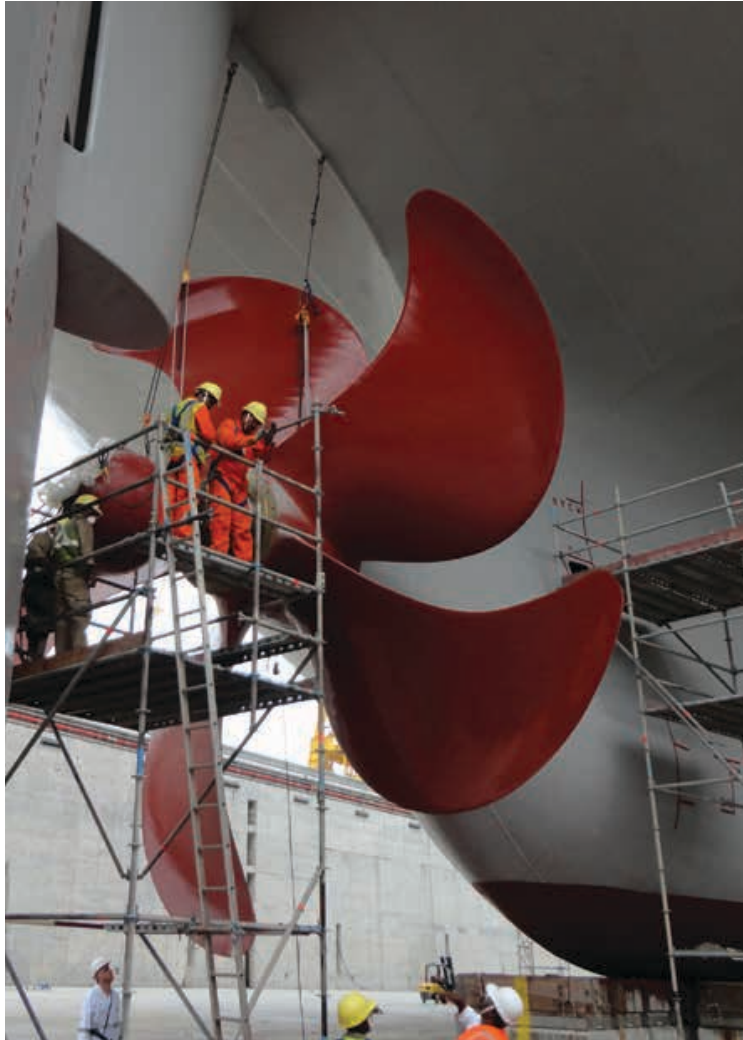

Fuel Efficiency Incentives

One issue that transcends any particular measure but is critical to the selection and adoption of efficiency improvements in vessels should be mentioned at the outset. For many vessels, the vessel's owner and/or operator does not directly receive the benefit in fuel savings of efficiency measures. The benefits often accrue to the charterer who pays for the fuel. Unfortunately, this reduces the owner's incentive to invest in efficient ships.

If arrangements can be developed for the owner and/or operator to accrue direct benefits from energy efficiency investments they may lead to significantly more efficient vessels. For owners unable to share the benefit of reduced fuel costs, the largest driver for adopting these measures may be the evolving regulatory regime and their own environmental policies.

Section 1

Hull Form Optimization

Introduction

Hull form optimization continues to be recognized as a growing field within the marine community as a means to improve energy efficiency of ships. When assessing hull form optimization the owner has three options available for consideration:

1. Accept the standard readily available hull form and propulsion system offered by the shipyard
2. Modify the existing and preferably well optimized hull form to address the expected operating profile
3. Develop a new design

Option 1 involves the least capital expense – substantive savings in vessel construction costs are often realized by adopting the standard design offered by a shipyard. Many of these standard ships have well optimized hull forms and propulsors, albeit usually only optimized at the design condition and to a lesser extent at the normal ballast condition or other service conditions. Hydrodynamic performance varies significantly with changes in draft and ship speed, however these operating conditions may not be fully considered in the original design.

Option 2 enables optimization of the design for specific service conditions (e.g. a number of expected operating draft, trim and speed combinations with their associated service durations). This optimization process generally involves modifications to the forebody design (the bulb and transition into the forward shoulder), and may involve modifications to the stern shape, particularly when excessive transom immersion is encountered at heavy load conditions.

Option 3 enables optimization of vessel hull particulars to be in concert with the propulsor and power plant, but this will result in an increase in capital cost of the vessel. However, option 3 is typically only justified when a particularly large series is being ordered, the shipyard under consideration does not offer a suitable standard design, the recovery by reduction in operational cost is realized or the ship requires unique characteristics to suit a niche service.

This section presents benchmarks for assessing efficiency, describes the methods available to today's naval architect for optimizing hull form and propeller, and outlines some of the issues that owners should consider in the assessment of the hull form aiming to enhance vessel fuel efficiency. The contents of this section are as follows:

Optimizing Ship Particulars

- Ship Size – Capacity
- Service Speed
- Principal Dimensions

Minimizing Hull Resistance and Increasing Propulsion Efficiency

- Optimizing the Hull Form (Lines)
- Forebody Optimization
- Aftbody Optimization
- Twin Skeg Design
- Appendage Resistance
- Maneuvering and Course-keeping Considerations

Added Resistance Due to Waves and Wind

- Assessing Added Resistance in Waves
- Assessing Added Resistance due to Wind

The Influence of IMO's EEDI on Ship Design

Optimizing Ship Particulars

Improvements in the sophistication and ease of application of analytical tools and techniques for vessel design have enabled the designer to optimize and explore alternative solutions that were previously unavailable. These tools take into consideration a range of disciplines such as hydrodynamics, ship structures, and environmental and safety performance (e.g. stability, oil outflow assessment and fire control). Multi-objective and multidisciplinary optimization software packages are being developed where these various tools are linked. Economic studies (e.g., a required freight rate assessment of parametric series of designs and comparative life cycle cost assessments) are routinely applied in the design optimization process and are beneficial for assessing the relative merits of standard designs offered by shipyards.

Ship Size – Capacity

Savings	For containerships, increasing size from 4,500 TEU to 8,000 TEU reduces fuel consumption for propulsion by about 25 percent (measured in terms of fuel consumption per tonne-nm of cargo transported). Increasing from 8,000 to 12,500 TEU reduces consumption by about 10 percent.
Ship Type	All ships. The largest savings occur for higher speed ships and are most significant for smaller sized vessels.
New/Existing Ships	All
Cost	Increasing size from 4,500 TEU to 8,000 TEU reduces construction cost in terms of about 15 percent (measured in terms of US\$ per TEU).

Figure 1 presents transport efficiency in terms of fuel consumption per tonne-mile of cargo moved (g/tonne-nm) for containerships as a function of capacity in TEUs. A service speed of 22.5 knots is assumed for all designs. The cargo payload is determined assuming stowage of 7 tonne/TEU average weight containers within the constraints of slot capacity, available deadweight, container securing restrictions and visibility limits.

As shown, significant reductions in fuel consumption per TEU transported can be realized through the economy of scale of employing larger capacity vessels. The relative improvement in fuel consumption diminishes as capacity increases and is fully realized only if the larger ships can be effectively utilized.

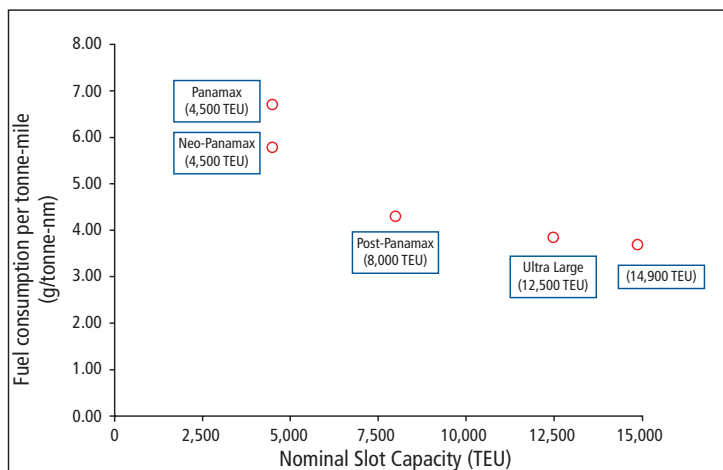

Figure 1. Containership – Transport Efficiency as a Function of Capacity in TEUs

Service Speed

Savings	For containerships of 4,500 TEU and above, reducing speed by 1 knot reduces propulsion fuel consumption by 12 to 15 percent. For oil tankers, reducing speed by 1 knot reduces fuel consumption by 17 to 22 percent.
Ship Type	All
New/Existing Ships	All
Cost	Some cost reduction if a smaller engine is selected.

A number of factors are considered when selecting the design speed. These include but are not limited to: the expectation of shippers; active market conditions; the speed required to maintain regular service; necessary sea margins for the intended service; and maximizing efficiency. The cost of fuel is a major component of operating expenses, and therefore the establishment of the optimal speed is particularly sensitive to fuel price. In addition the inventory rate of cargo (the time value of cargo shipped) is also a significant factor.

For any service with estimated cargo quantities per annum and a target fuel cost, the optimum design speed can be determined from an economic analysis such as a required freight rate (RFR) analysis. This analysis includes the number of ships necessary to meet the cargo demands at some speed, capital costs and operating costs. It is a convenient way of judging the economic efficiency of a range of designs. If one is considering acquiring new vessels, performing this RFR analysis over a range of potential fuel

costs is a good way to determine the most efficient speed at the outset.

Designing for the right speed, or right range of speeds, has other benefits as well. A hull form optimized for the slower speed usually means a fuller form and higher cargo deadweight. It is also possible to refine the hull form for multiple drafts and possibly multiple speeds if cargo quantities may vary or there are significant ballast legs. The main engine and propeller can be optimized around the slower speed for maximum benefit.

Figure 2 shows the results of an RFR analysis for the transpacific container service, of a parametric series of 39.8 m beam containerships with a range of design speeds with each design optimized for its design speed. The RFR includes amortization of ship construction costs, operating expenses, fuel oil costs, canal fees, port fees and cost of inventory. Each design is optimized for the design speed, including adjustments to the block coefficient, installed power, etc. For example, the 25 knot design has a block coefficient of 0.62 and a slot capacity of 5,397 TEUs, whereas the 17.8 knot design has a block coefficient of 0.80 and a slot capacity of 5,773 TEUs.

Given these assumptions, the design's optimal speed is 24 knots with heavy fuel oil (HFO) at \$600/tonne, 21 knots with HFO at \$900/tonne and 19 knots with HFO at \$1,200/tonne. This study assumes each vessel maintains a constant speed over the voyage with a constant sea margin. The next level of sophistication involves analyzing each leg of a voyage at anticipated speeds and drafts, including assessing the impact of emission control areas (ECAs) and the higher cost of marine gas oil (MGO).

When selecting the service speed for liner services, customer expectations and the need for regularity of service should also be introduced into the study. For charter markets, the variability in charter rates should be accounted for, which tends to encourage a higher service speed so revenues can be maximized when rates are high.

If the only focus of designing for slower speeds is low fuel consumption or low EEDI, the result

may be low powered ships that may not operate safely in heavy seas or maneuver and stop safely. Such low powered ships may seem economically attractive at first, but the owner and designer should guard against such designs. Because of these concerns the issue of a minimum power requirement is being addressed by IMO.

Principal Dimensions

Savings	Increasing the length/beam ratio and/or increasing length and reducing the block coefficient can provide reductions in propulsion fuel consumption up to 3 to 5 percent.
Ship Type	All
New/Existing Ships	New
Cost	As compared to increasing beam or depth, length is the more expensive dimension. For example, increasing L/B on an Aframax tanker from 5.5 to 5.75 while holding the ship speed and cargo volume constant increases construction cost by roughly 0.25 to 1 percent.

Increasing the length while reducing the beam and maintaining the draft, displacement and block coefficient (C_b) constant typically yields improvements in hull efficiency, provided additional ballast is not needed to maintain adequate stability. A higher length/beam ratio tends to reduce wavemaking resistance, while the reduced beam/draft ratio tends to reduce wetted surface and therefore the frictional resistance.

Increasing draft by reducing C_b and/or beam results in improvements to hull efficiency, and may provide the additional advantage of allowing for a larger propeller to be fitted. Increasing length while reducing C_b will reduce the required power. This is because over typical ranges of length/beam and beam/draft ratios the reduction in wavemaking resistance from increased length and reduced C_b offsets increases in wetted surface and therefore the frictional resistance. In addition, reducing beam while increasing C_b also tends to reduce required power. In this case, there is a point after which the increased wavemaking resistance

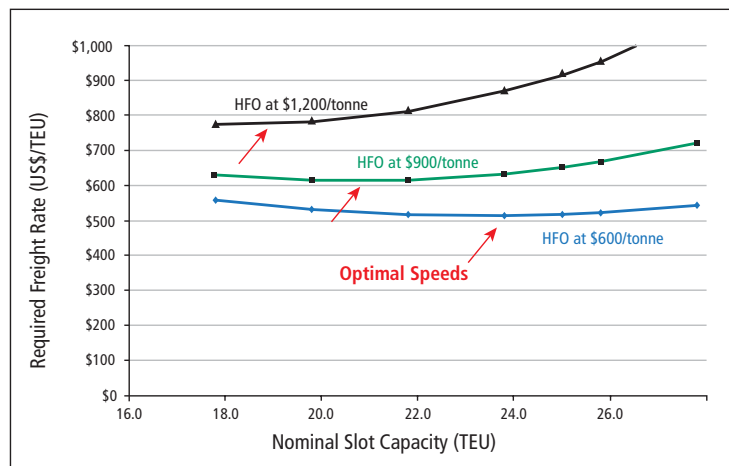

Figure 2. Containership Design Speed Parametric Study

associated with the higher C_b offsets the beneficial effects of the higher length/beam ratio and reduced wetted surface.

The longitudinal prismatic coefficient (C_p) is a commonly applied indicator of the longitudinal distribution of displacement. A lower C_p , favored for faster ships, implies a greater concentration of displacement amidships and a finer entrance angle. Tankers and bulk carriers with fuller (bluff) bow shapes will have a higher C_p .

Of course, main particulars and hull coefficients cannot be selected based on hydrodynamic principles alone. Other factors to consider include the accommodation of the cargo block and main propulsion units; and the minimization of ballast and restrictions from port and canal infrastructure. Such design constraints are assessed against economic factors – the goal is to minimize both operating costs, including fuel consumption, and construction costs.

The principal dimensions of modern designs offered by the major shipyards are generally well optimized. Small reductions in RFR in the range of 1 to 3 percent can be realized by increasing the length/beam ratio (more slender designs) for example, as the lower fuel consumption more than offsets the increased capital cost related to increased steel weight. Other factors must be taken into consideration such as berth availability for the longer ships and structural reliability as the length/depth ratio increases. Nevertheless, encouraged by rising fuel costs, the longer term trend will be towards increasing the length/beam ratio and reducing the block coefficient or reducing the design speed.

For designs with high C_b , with the longitudinal center of buoyancy (LCB) pushed forward, and/or buttock flow aft, the directional stability should be carefully evaluated during the initial design process.

It is important that studies to determine optimal dimensions take into account the effects of slowdown in various sea conditions, partial load and ballast conditions, and voyage legs where reduced speed and/or draft are anticipated. For early stage analysis, semi-empirical approaches such as Townsin are adequate for estimating slowdown in seas. As the design progresses, model tests in waves and numerical analysis provide a more refined indication of the behavior of the specific hull form in seas.

Minimizing Hull Resistance and Increasing Propulsion Efficiency

Savings	Propulsion fuel reductions of 5 to 8 percent are anticipated through further optimization of hull forms and propellers.
Ship Type	All
New/Existing Ships	New
Cost	Multi-pass model test and CFD programs typically cost \$200,000 to \$500,000 per class of vessel.

Optimization of the hydrodynamic performance of a vessel's hull form and propulsor in order to achieve the least required power and best propulsion efficiency involves several interrelated efforts:

- Optimization of the hull form given the principal particulars (lines development)
- Optimization of the propeller(s) for the flow from the hull and installed machinery
- Design and arrangement of the rudder in relation to the propeller and flow lines
- Study of optimal energy-saving devices

Where the hull form and the propeller are highly optimized, the benefits offered by energy-saving devices are small. However, devices with low capital costs and high reliability (i.e. little risk of unexpected maintenance costs) may justify consideration for newbuildings. Examples include propeller bossings and rudder bulbs. Energy-saving devices are discussed in Section 2 of this Advisory along with the characteristics of high efficiency propeller options.

Optimizing the Hull Form (Lines)

Benchmarking: Efficiency of Existing Designs

Whereas principal particulars are generally well optimized across shipyards, there is significant variance in the extent of hull form and propeller optimization. To fully optimize a hull form, a comprehensive series of model tests and computational fluid dynamic (CFD) assessments are needed. This methodical approach to optimization has not been universally applied. Also, shipyards tend to optimize around the specified design draft. Less attention is paid to the efficiency at the ballast draft, and little or no attention is paid to partial load conditions.

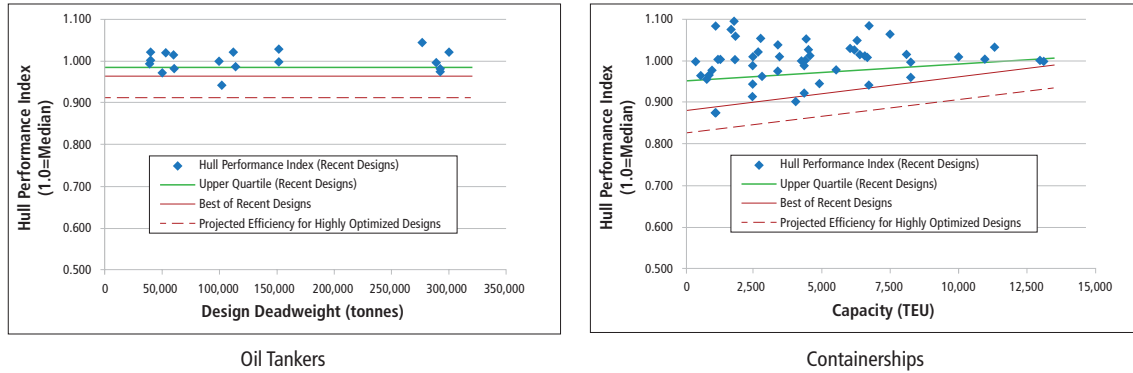

Figure 3. Hull Performance Comparison

Figure 3 compares the performance at the design draft of representative newbuildings offered by major yards over the last ten years. The Holtrop-Mennen regression formula for assessing hull resistance and standard propeller series were applied to nondimensionalized performance data, adjusting for variations in particulars (LBP, beam, draft, Cb) and service speed. Performance is plotted relative to 1.0, which represents the median performance of the ships evaluated. For example, a hull performance index of 1.03 indicates that the ship requires approximately 3 percent more power than the median while an index of 0.96 indicates the required power is 4 percent below the median value. The green line represents the upper quartile of top performing ships. That is,

those 25 percent of ships exhibiting the best overall performance fall below this line.

There is considerable variation in the efficiency of containerships. For tankers, the variation is somewhat less, but still significant. Thus, it is in the interest of the shipowner to carefully assess the efficiency of existing designs offered by shipyards.

Encouraged by continued shipowner interest in minimizing fuel consumption and the newly adopted IMO EEDI, greater attention is being given to hull form and propeller optimization. The best of today's designs perform roughly 5 percent better than the upper quartile line, and we believe that a further 3 to 5 percent improvement is possible above today's best designs. There is no reason to

Table 1. Standard Oil Tanker Designs – Upper Quartile Hull Performance

		Panamax Product	Aframax Crude	Suezmax Crude	VLCC Crude
Cargo Capacity	m ³	54,000	132,000	180,000	360,000
Length Overall	m	182,000	249,000	280,000	333,000
LBP	m	174,000	239,000	270,000	320,000
Beam	m	32,200	44,000	48,000	58,000
Depth	m	19,000	21,200	24,000	31,200
Design Draft	m	11.20	13.60	15.90	21.00
Summer Load Line Draft	m	12.62	15.06	17.41	22.05
Lightship	tonnes	10,052	19,310	25,819	43,258
Design Block Coefficient		0.800	0.825	0.825	0.820
Deadweight at Design Draft	tonnes	41,533	101,932	148,869	285,154
Deadweight at Load Line Draft	tonnes	49,203	116,135	166,576	303,032
Number of Screws		1	1	1	1
Sea Margin		15%	15%	15%	15%
Design Service Speed at 90% MCR	knots	14.9	14.9	15.2	15.8
Required Engine Power (100% MCR)	kW	9,085	13,746	17,976	26,722

Table 2. Standard Containership Designs – Upper Quartile Hull Performance

		Feeder	Panamax	Neo-Panamax	Post-Panamax	Ultra Large
Slot Capacity	TEU	1,000	4,500	4,500	8,000	12,500
Length Overall	m	145,248	295,625	280,145	333,256	388,396
LBP	m	136,000	275,000	260,600	308,000	356,000
Beam	m	23,400	32,200	34,800	42,800	48,200
Depth	m	11,750	21,000	19,300	24,500	29,850
Design Draft	m	7.60	11.80	11.80	13.00	14.20
Summer Load Line Draft	m	8.51	13.22	13.22	14.56	15.90
Lightship	tonnes	5,022	19,119	19,071	31,752	47,063
Design Block Coefficient		0.655	0.630	0.630	0.630	0.665
Deadweight at Design Draft	tonnes	11,257	48,524	50,206	79,187	119,437
Deadweight at Load Line Draft	tonnes	13,669	58,817	60,747	96,068	143,865
Number of Screws		1	1	1	1	1
Sea Margin		15%	15%	15%	15%	15%
Design Service Speed at 90% MCR	knots	18.5	24.5	24.5	25.0	25.0
Required Engine Power (100% MCR)	kW	8,355	38,121	41,664	58,966	75,705

accept a design that does not perform in the upper quartile of vessels built in the last decade, and efficiency levels exceeding today's best performing vessels should be anticipated in the near future.

When assessing the efficiency of an offered design, it is often useful to compare typical designs of similar size. Table 1 and Table 2 show 'standard' designs for the more popular sizes of oil tankers and containerships. The principal particulars were determined by regression from recent newbuildings, and the required power is based on 'upper quartile' performance as described in Figure 3.

Lines Development and Testing Program

Where a new hull form is being developed, a reiterative process of CFD analyses and model tests is highly recommended. A typical process may involve three or more iterations of lines refinement, CFD analysis and resistance and propulsion model tests. These should be carried out for at least three drafts and multiple trims, over a range of speeds. A thorough testing program, which may cost between \$200,000 and \$500,000, is readily justified for multiple ship programs.

Free surface potential flow calculations, also referred to as inviscid calculations, are now a routine part of hull form optimization. Such calculations may be incorporated into the parametric studies for principal dimensions, particularly to ascertain the impact of shifts in the LCB and adjustment to C_b. CFD is useful

in assessing the influence of changes to the entrance angle, optimizing the location and shape of the fore and aft shoulders, and as described below, optimizing the bulbous bow. CFD is to be employed sequentially, allowing for refinement of shape and elimination of less favorable variations. This will enhance the effectiveness of the CFD by reducing the number and scope of more costly model tests. Potential flow calculations can reasonably predict the impact on wavemaking resistance of hull form design variations, particularly in the forebody. However, wave breaking effects cannot be evaluated with such codes. These inviscid calculations are also not effective for evaluating hull changes which impact flow about the aftbody where viscous effects on wave resistance can be more pronounced. This includes conditions of transom immersion resulting in wetted-transom flow (i.e. turbulent flow in way of the transom).

There is substantive potential for fuel savings by optimizing for the off-design conditions where the expected operating profile differs from a single design draft and design speed. Changes in draft, trim and speed can dramatically change the wave profile and overall resistance. Therefore, the owner and designer should prepare a clear specification of the different operating drafts and speeds on different legs of the expected voyages. Numerical analysis and model tests should then cover the operating conditions at which the vessel may spend a significant portion of its time at sea.

By giving appropriate consideration to the off-design conditions (partial load, slower speed and ballast conditions), significant improvements in efficiency at these other design points may be realized with little or no impact on the design draft performance. For example, the Hamburg Ship Model Basin (HSVA) reports a 12 to 16 percent improvement in resistance and delivered power for a 70 percent design draft, 80 percent design speed condition. This was achieved by optimizing just the bulb and extreme forebody, without any loss of performance at the design condition. The speed differential between the full load condition and ballast condition for tankers built in the last ten years ranges from about 0.7 knots to 1.2 knots.

As few designers are comfortable using CFD for quantitative assessment of required power, model tests are recommended for final power prediction. Model tests also provide the designer with the opportunity to observe wave patterns, and the three-dimensional wake measurements provide a picture of the wake flow into the propeller. Model tests generally have accuracy within 2 to 3 percent, although even the best of model basins can have significant errors when evaluating less conventional designs. Particular care should be taken when evaluating atypical designs with features that do not scale well, such as significant transom immersion.

When developing lines, numerous trade-offs are considered. Although considerable progress is being made in numerical hull form shape

optimization tools, the creation of lines remains part art and part science, and there is still no substitute for the experienced designer. There is considerable advantage in beginning with a good parent hull of similar proportions, and in having an extensive database for benchmarking purposes. Therefore, many of the best performing hull forms are developed by the major model basins or yards with their own proven testing facilities, well validated through full scale trial comparisons.

Approach to Improving Key Elements of Resistance

As shown in Figure 4, viscous (frictional) resistance is the major component of overall resistance, accounting for between 70 and 93 percent of the total resistance in tankers and containerships. The percentage of total resistance attributed to viscous (frictional) resistance is greatest for slower, larger ships. Wavemaking resistance increases with ship speed and is a larger component of overall resistance for high-speed, fine-form ships than it is for slower, full form ships.

When developing a full body hull form such as a tanker, emphasis is placed on reducing wetted surface as viscous resistance is such a major component of overall resistance. Another important consideration is to provide a smooth and gradual transition to the propeller, to avoid separation of flow at the stern and provide for a uniform wake field (i.e. constant axial velocities at each radius). This encourages the LCB to be as far forward as practical, although care must be

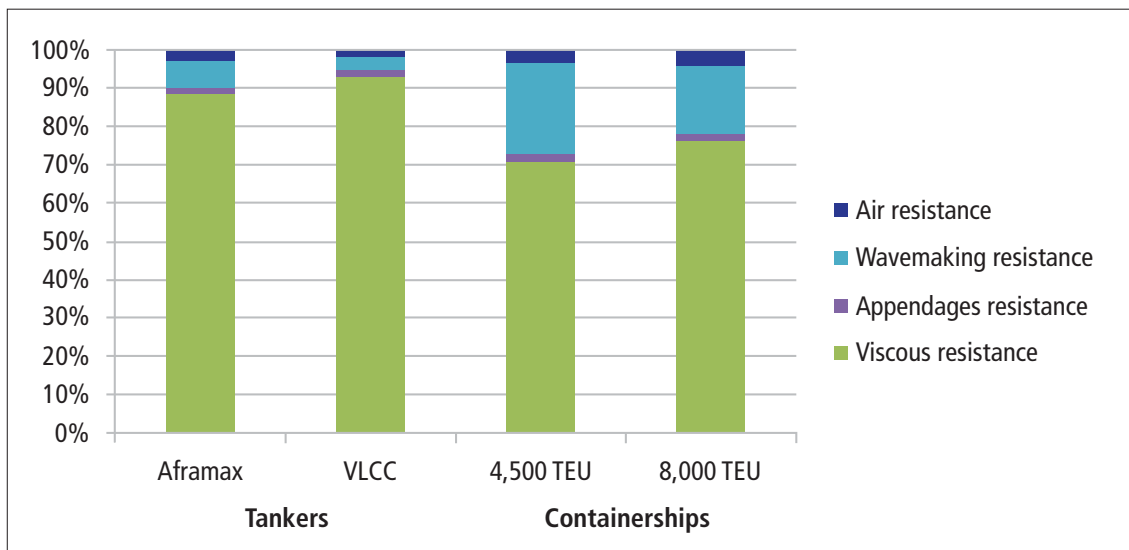

Figure 4. Components of Hull Resistance in Calm Water Conditions at Design Speed

taken to avoid a harsh shoulder forward. Mitigating wave propagation at the forward shoulder is more important than reducing wavemaking. Employing blunter bow shape is encouraged over finer bows. Blunt bows tend to accommodate a smoother transition. The blunter bow shape allows a shift in volume from the midship region into the forebody region, resulting in better overall resistance performance for full body ships.

For higher speed and therefore finer hull forms typical for larger containerships, wavemaking is more significant (23 percent and 18 percent of total resistance for the standard 4,500 and 8,000 TEU containerships). Such a vessel will have more slender proportions as compared with a tanker, with a higher L/B ratio. In this case, the more slender and finer hull allows the LCB to be moved aft while still maintaining good flow into the propeller. This enables a reduced entrance angle and softer forward shoulders. The bulb on a containership will be elongated with finer shape to reduce wavemaking resistance.

Forebody Optimization

Forebody optimization includes consideration of the bulb design, waterline entrance, forward shoulder and transition to the turn of the bilge. Potential flow calculations are routinely applied in this optimization process.

The properly designed bulbous bow reduces wavemaking resistance by producing its own wave system that is out of phase with the bow wave from the hull, creating a canceling effect and overall reduction in wavemaking resistance. The flow is more horizontal, reducing eddy effects at the forward bilge. Physical factors considered in bulb optimization include volume, vertical extension of the center of volume, longitudinal extension and shape. A bulb with a reverse pear-shaped section is primarily effective at the design condition, pear-shaped bulbs work best for drafts below the design draft (i.e. ballast draft or partial load draft) and cylindrical shaped bulbs offer a compromise solution.

A V-shape may be introduced at the base of the bulb to mitigate slamming impact loads. Faster, more slender vessels favor larger volume and forward extension of the bulb. ‘Goose-neck’ type and stretched bulbs are particularly effective when draft and speed vary over a small range. Fuller ships such as tankers and bulk carriers are often arranged with bulbs having a large section area

and V-shaped entrance, such that it behaves as a traditional bulb at loaded draft and acts to extend the waterline length at ballast draft. In combination with optimization techniques, the bulbous bow design should be developed in a careful manner using free-surface potential flow or viscous flow calculations. Larsson and Raven address further details on bulbous bow and forebody design in their *Principles of Naval Architecture Series*.

The characteristics of the bulbous bow must be carefully balanced with the shape of the entrance and the transition towards the forward shoulder and bilge. Bulbs are most effective at certain Froude number (speed-length ratio) and draft. Changes in speed and draft significantly change the wave created, such that reductions in draft or speed can actually lead to increases in wavemaking resistance. As few commercial vessels operate solely at a design draft, compromises in the bulb design are needed to provide good performance over the expected range of operating drafts and speeds. Maersk Lines reports fuel savings of over 5 percent by modifying the bulbous bow of a shipyard design which was optimized to the design draft, so that it provided more favorable performance over the anticipated operating profile of drafts and ship speeds.

Bow flare also influences motions and added resistance in waves. V-shaped rather than U-shaped flare is generally preferred, as it tends to reduce motions without adding resistance. The increased resistance in heavy seas due to pronounced flare is currently not fully understood, and consequently rarely considered during the design process; however efforts are ongoing to develop an understanding.

Aftbody Optimization

Aftbody optimization includes efforts to mitigate stern waves, improve flow into the propeller and avoid eddy effects. A properly designed stern can reduce the aft shoulder crest wave as well as the deep wave trough and stern waves. Improving the nature of the stern flow can lead to improved propulsive efficiency. (Flow improving devices such as stern flaps may be beneficial; these are discussed in Section 2.) Potential flow calculations are used to evaluate wavemaking effects through the aft shoulder. However, viscous flow calculations are needed to evaluate aftbody flow through the propeller and wetted transom flows in way of a submerged transom because these are dominated by viscous effects. Significant progress in the development and application of viscous flow



CFD codes has been achieved in recent years, to the point where propulsor-rudder interaction can be effectively evaluated.

Single screw sterns forward of the propeller may be V-shaped, U-shaped or bulb types. The tendency today is towards the bulb shape, as the improved wake reduces cavitation and vibration. Asymmetrical sterns are designed to improve propulsive efficiency through pre-rotation of the flow to the propeller and to some extent by reducing the thrust deduction. The pre-rotation of the flow into the propeller helps reduce the separation of flow in the stern aft of the propeller. To date, these enhancements have not been proven to be sufficiently effective to offset the extra cost and complexity involved in construction, with the exception of some twin skeg designs.

Twin Skeg Design

Twin screw propulsion arrangements offer enhanced maneuverability and redundancy, and are also adopted when the power required for a single propeller is excessive. Propulsion power may exceed what can be handled reasonably by a single propeller if, for example, the vessel design is draft limited and the propeller diameter is correspondingly reduced. For a twin screw design there is the choice of open shafts with struts or twin skegs (or gondolas).

For twin screw propulsion with open shafts, efficiency is generally compromised when compared to a single screw design, in part due to the high appendage resistance from struts and bearings. The introduction of the twin gondola type skeg design eliminates the need for these appendages, and can provide favorable hydrodynamic performance, especially for full-bodied ships ($C_b > 0.70$) and those with wide beams and/or shallow drafts. For slender, higher powered ships the open shaft twin screw design may be more favorable when two propellers are required because the open stern shape provides lower wake variation resulting in less cavitation and vibration.

For full-hull form ships, the Swedish testing facility SSPA has found that the twin skegs provides a 2 to 3 percent efficiency improvement over well optimized single screw designs with corresponding characteristics. If the propeller diameter on a single screw design is suboptimal due to draft restrictions, unloading of the propellers in twin skeg arrangements can lead to efficiency improvements of 6 percent or more.

These gains in efficiency of the twin skeg design over a single screw design accrue for the following reasons:

- Each skeg can be more slender than the centerline skeg of the single screw design. This provides for a better wake field, less cavitation and lower induced pressure pulses to the hull.
- The LCB can be further aft, enabling a finer entrance angle forward and a corresponding reduction in wavemaking resistance.
- Twin skeg design offers improved directional stability.

While there are improvements in the overall efficiency of the vessel, relative to fuel consumption, the fitting of twin skegs does have disadvantages that should be evaluated. The most notable of these disadvantages are:

- The wetted surface is typically about 4 to 5 percent higher for a twin skeg versus a single screw design. The lower the C_b , the more pronounced the effect on wetted surface.
- The hull steel weight is increased (by roughly 4 to 5 percent for tankers).
- Twin skeg arrangements are more expensive to build.

The optimum design and positioning of twin skegs must consider several factors. Balance of flow between the inner side and outer side of the skegs is important, which is influenced by the distance between the skegs, the tilt and the shape of the skegs. Finer, asymmetrical skegs angled to allow for pre-rotation can improve propeller efficiency, but care must be taken to maintain straight streamlines and prevent flow over the skegs. Adequate clearance over the propellers should be provided, but excessive clearance can lead to reduced velocity in way of the upper portion of the propeller. The transition into the tunnel must not be too abrupt, and the rake of the stern not so steep to induce separation of flow.

As there are numerous design and installation arrangements for twin skegs, each unique to the specific vessel design, it is essential that a multi-pass optimization effort consisting of CFD and model testing be employed to achieve the desired results. It is recommended that these multi-pass model tests include an assessment incorporating both inboard and outboard rotating propellers and an evaluation of the optimum rudder angle.

Appendage Resistance

For cargo vessels in calm water conditions, appendage resistance is about 2 to 3 percent. Roughly half of the appendage resistance is

attributable to the rudder and half to bilge keels. Rudder resistance can increase substantially in severe wind/weather conditions or for directionally unstable ships.

Added resistance from a bow thruster tunnel can be significant (in the range of 1 to 2 percent of calm water resistance). Grid bars are frequently placed over the opening perpendicular to the flow direction. They serve to break up laminar flow and reduce vortices. Anti-suction tunnels can be used to reduce the pressure variation across the bow thruster tunnel.

Maneuvering and Course-keeping Considerations

A high block coefficient, forward LCB, lower length to beam ratio and open stern are factors that can lead to reduced directional stability. Accordingly, performance should be assessed through computation means or by model tests, either through captive tests in a towing tank or by free running model testing in an open basin. Where the vessel's operational requirements necessitate the use of a hull form with reduced directional stability, effective course-keeping can be provided by larger rudders, high performance rudders or skegs, which will induce a penalty in overall efficiency when compared to vessels not provided with such rudders or skegs. In such cases, viscous flow CFD assessment and model tests are recommended as the drag and added resistance resulting from the larger rudders, high performance rudders and skegs can vary substantially.

Added Resistance Due to Waves and Wind

It is traditional to concentrate on calm water resistance during the ship design process. This is due to a number of factors: the calm water performance is used as a basis for the shipyard guarantee; for a displacement hull, the weather effects are normally a relatively small part of total resistance, usually less than 10 percent of total resistance; predicting the slowdown due to wind and waves is a complicated problem leading to a high level of uncertainty; and the designers' options for improving performance in heavy seas are somewhat limited and often overridden by other considerations.

The degradation of performance in a seaway is normally accounted for by applying a sea margin, which is a specified increase in power to account

for the effects of hull fouling and slowdown in weather. The sea margin is selected based on the type of vessel, the projected trade routes, owner experience and the criticality of maintaining schedule. It is usually in the range of 10 to 25 percent, with a 15 percent sea margin most commonly applied.

Most of the time, oceangoing vessels typically operate in sea state 3 or higher a majority of the time. For example, in the North Atlantic the probability of exceeding sea state 3 is about 60 percent and exceeding sea state 7 is about 10 percent. In sea states 3 to 5, the vessel is using its sea margin of 10 to 15 percent. Resistance from waves increases by the square of the wave amplitude and resistance from wind by the square of the apparent wind speed. In sea states 7 and above, the added resistance from wind and waves can exceed the calm water resistance.

Where there is power margin available, the increased resistance is seen as an increase in fuel consumption. When the vessel is operating at full power, the increased resistance translates into a reduction in speed and longer voyage duration also resulting in an increase in fuel consumption. This involuntary slowdown is accentuated for vessels with slow-speed diesel propulsion plants connected to fixed pitch propellers, as the increased resistance leads to an engine overload condition that is reconciled through a reduction in propeller rpm and torque. Where motions and impact of seas are so extreme as to endanger the ship, its cargo or crew, the Master will elect to voluntarily reduce speed. Excessive slamming, green water on deck, propeller emergence and racing and high accelerations induced by pitch and roll motions are inducements for voluntary speed reduction.

There is a growing awareness among ship designers and shipowners of the importance of evaluating weather effects on performance throughout the design process. During the initial stage of design, consideration of wind and wave effects can influence ship proportions (increasing length/beam, reducing C_b , increasing freeboard, limiting bow flare). In particular, at higher sea states the added resistance in waves is directly related to the ship's beam and waterplane shape. A more accurate assessment of sea margin, accounting for the behavior of the specific vessel and intended trade route will help determine the engine margin and propeller design point.

Although a smaller portion of the total resistance, wind resistance becomes more prominent for vessels having a large windage area such as containerships with large deck cargoes and pure car carriers (PCCs). For PCCs, in particular, wind side force and resulting yaw moment are significant. This force is counter-balanced by the rudder, inducing additional drag. Unlike underwater resistance which is dominated by frictional drag, wind resistance is primarily due to the pressure drop at the separated zone on the leeward side. Reductions in total power of up to 6 percent are claimed for PCCs, primarily by smoothing the topsides transition.

Added Resistance in Waves

Seakeeping software including strip theory and panel codes are commonly used for assessing added resistance in seas. These codes are not yet particularly reliable, and where possible should be benchmarked against model tests. Estimates can also be made by empirical methods derived from model test data and statistical methods (examples include Maruo and Hosada). Again, caution must be exercised when applying the theoretical and statistical methods, as results obtained with the different methods vary substantially. Nevertheless, these tools are useful for understanding trends and identifying concerns. Model tests in regular and irregular waves remain the most reliable means for evaluating added resistance from waves as well as shipping of green water.

Added Resistance Due to Wind

Wind resistance can contribute up to roughly one-third of the total added resistance from wind and waves. Empirical methods developed by Isherwood, Blendermann and OCIMF are available for estimating the added resistance from wind. These formulas were determined by the regression of wind tunnel test data for a variety of ship types and sizes. These approaches do not give consistent, comparable results, so again care must be taken in the quantitative analysis of the added resistance due to wind.

Wind tunnel tests have been and remain the preferred approach for predicting the added resistance from wind, from excessive rudder use because of wind forces affecting maneuverability and plume effects around stacks. CFD application for predicting wind forces on ships is in its early stages and requires further validation.

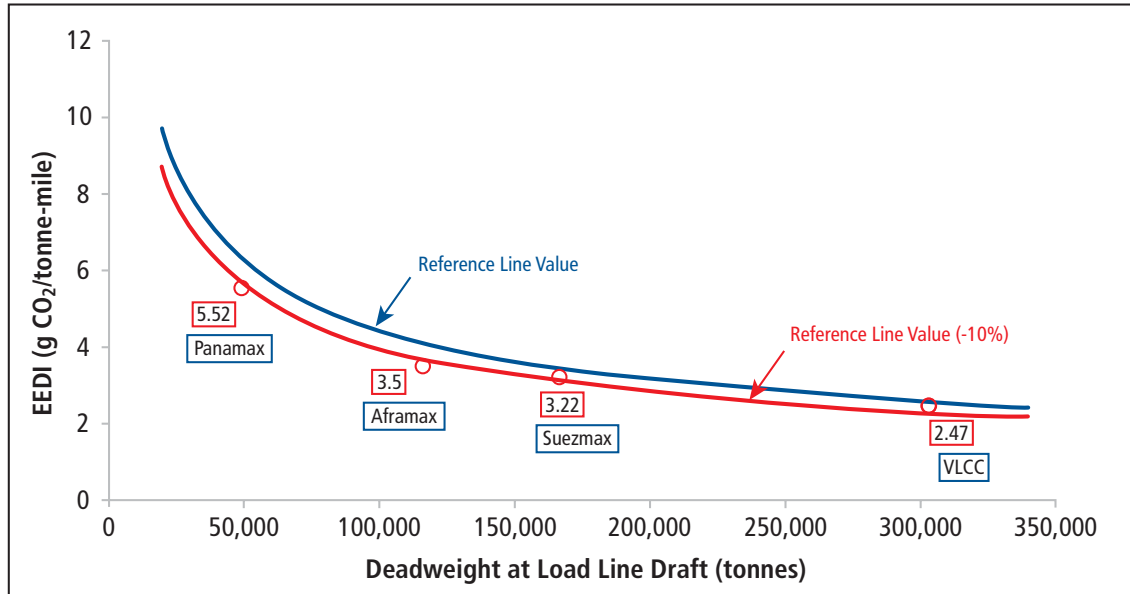

Figure 5. EEDI Assessment for Standard Tankers

The Influence of IMO’s EEDI on Ship Design

The IMO EEDI for new ships is encapsulated in a single formula that estimates CO₂ output per tonne-mile. The numerator represents CO₂ emissions after accounting for “innovative” machinery and electrical energy efficiency technologies that are incorporated into the design. The denominator is a function of the speed, capacity and ship-specific factors. To determine compliance, the attained EEDI for a newbuilding is compared to a baseline value.

New ships contracted as of 1 January 2013 and with delivery not later than 30 June 2015 must have an attained index at or below the EEDI reference baseline. For vessels with a building contract from 1 January 2015, the reference baseline is reduced by 10 percent. The baseline is further reduced for contracts placed as of 1 January 2020.

IMO developed individual reference baselines for the different ship types. The baselines are derived from historical data – generally ships built over the prior ten years. As IMO did not have access to complete design data on these ships, simplifying assumptions were made to facilitate calculations. For example, a specific fuel oil consumption of 190 g/kWh was assumed for all main propulsion engines, which is IMO’s estimate for consumption of representative slow-speed diesel engines

burning HFO. The EEDI regulation calls for application of the specific fuel consumption at 75 percent MCR listed on the Engine International Air Pollution Prevention (EIAPP) certificate.

Testbed measurements for the EIAPP certificate are normally done for MDO under ISO conditions. Also, there is considerable uncertainty in some of IMO’s historical data for ship characteristics, especially the assumed service speed for each vessel. IMO developed the reference baseline for each ship type by fitting a single exponential curve to the data. In some cases, the single curve does a poor job in representing the mean of performance data for all ship sizes. ABS developed a paper evaluating options on the EEDI baseline for SNAME and the Marine Board Symposium.

Figure 5 compares the attained EEDI values for the standard tanker designs listed in Table 1 to the reference baseline for tankers (the blue line) and the reference baseline reduced by 10 percent (the red line). The standard ships have principal dimensions and service speeds that are representative of ships built in the last ten years, but have installed propulsion power based on the efficiency attained by the upper quartile of modern designs. As expected, all of these standard tankers satisfy the EEDI requirements (i.e. fall below the reference baseline). The smaller vessels (the panamax and aframax tankers) meet the baseline less 10 percent, meaning good optimization of lines and propulsors should be all

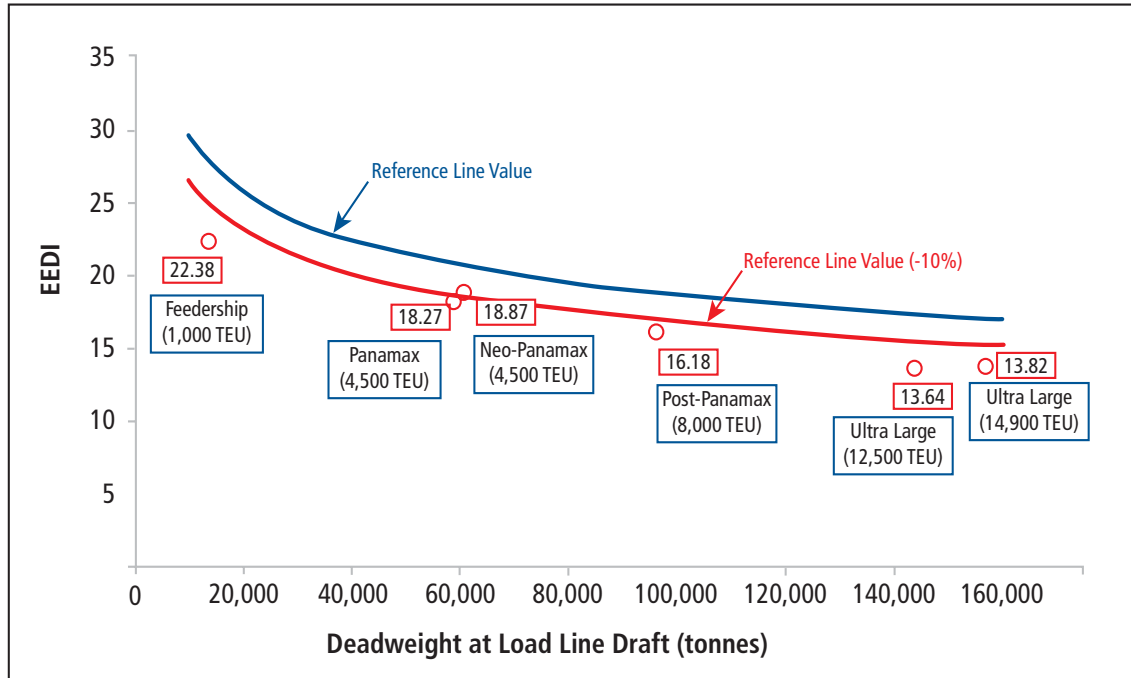

Figure 6. EEDI Assessment for Typical Containerships

that is required to satisfy the EEDI requirements through 2020. Some further improvements in efficiency will be required for suezmax and VLCC sized tankers, but it is believed this level can be achieved through further hull form and propulsor optimization and without resorting to the introduction of innovative technologies. As discussed in this Advisory, additional improvements are possible through energy-saving devices and enhancements to the power plant (e.g., waste heat recovery).

The ship reference speed, which is determined from the speed trial analysis, is a crucial parameter in establishing the EEDI. The EEDI calls for the trial speed to be determined in accordance with ISO 15016. Corrections based on simplifying assumptions are made for sea state, wind and current. If speed trials are not conducted at the reference draft, trim and draft corrections are applied based on model test data. Sea trials should be carefully monitored, as the accuracy of sea trial results will be affected by the trial conditions, the proper application of correction factors and the quality of model tests.

Figure 6 compares the attained EEDI values for the standard containership designs listed in Table 2 to the reference baseline and the baseline less 10 percent. All of the standard containerships meet the reference baseline, and all designs with

the exception of the neo-panamax containership meet the baseline less 10 percent. This indicates that designers should have little difficulty meeting the EEDI requirements through 2020 without resorting to innovative technologies or reductions in service speed.

As shown in Figure 1, the fuel oil consumption per tonne-nm of cargo transported for the neo-panamax containership is about 14 percent less than the panamax containership of the same nominal TEU capacity. The wider beam on the neo-panamax containership enables a more stable hull form, significantly reducing the need for ballast. Although the neo-panamax is more economical than the panamax design (i.e. the cost to move a TEU is much less), the hull of the panamax containership, having a higher length/beam ratio, is hydrodynamically more efficient. The EEDI uses deadweight rather than 'usable' TEU capacity as a measure of cargo carried, and therefore does not distinguish between a tonne of cargo and a tonne of ballast.

As shown in Figure 6, the EEDI methodology rates the panamax design as more efficient (having a lower attained index). As a result, to meet the EEDI standard after 2015 the neo-panamax containership will likely require some innovative technologies or a reduction in design service speed.

Section 2

Energy-saving Devices

Introduction

Many different devices have been studied to either correct the energy performance of suboptimal ship designs, or to improve on already optimal or nearly-optimal standard designs by exploiting physical phenomena usually regarded as secondary in the normal design process, or not yet completely understood.

This section explores a range of these devices, most of which historically concentrate on the improvement of propeller propulsion effectiveness. However, recent developments have led to a series of devices aimed at either reducing the hull frictional resistance or exploiting readily available natural resources, such as solar and wind energy. Some of these devices are also examined in this section. The contents of this section are as follows:

Propulsion Improving Devices (PIDs)

- Wake Equalizing and Flow Separation Alleviating Devices
- Pre-swirl Devices
- Post-swirl Devices
- High-efficiency Propellers

Skin Friction Reduction

- Air Lubrication
- Hull Surface Texturing

Renewable Energy

- Wind
- Solar

Compatibility

- Ship Design Characteristics/Ship Type
- Mutual Compatibility

All of these devices are intended to reduce the propulsion fuel consumption. The PIDs and skin friction reduction technologies do this by reducing hull resistance and/or increasing propulsive efficiency. The renewable energy sources take the place of some portion of the purchased fuel. Many

of the devices are not mutually compatible or applicable to all ship types. An effort is made to highlight compatibilities as shown in Figure 31 for ship types and Figure 32 for devices or PIDs.

Some of the devices discussed in this section, including those based on renewable energy, are pushing the envelope of the current state of technology and may not be ready for implementation. These technologies are struggling to gain a significant role in our industry because of the high implementation cost (be it due to high capital cost to energy generation ratio, or because of the intrinsic operability envelope limitations of the device) and difficult integration of these energy-saving measures in the ship's design and operation. Often, these issues have prevented the utilization of renewable energy on ships, particularly when the economic risk of its adoption cannot be readily quantified, as is the case for most new technologies.

Propulsion Improving Devices (PIDs)

Wake Equalizing and Flow Separation Alleviating Devices

Savings	0 to 5 percent reduction in propulsion fuel consumption.
Applicability	Best suited to correct known existing hydrodynamic problems.
Ship Type	All medium and lower speed ships
New/Existing	New and retrofit
Cost	Low to medium-low, depending on the device. Maintenance cost can be an issue.

In general, wake equalization and flow separation alleviating devices are features to improve the flow around the hull that were developed to obviate propeller problems and/or added ship resistance caused by suboptimal aft hull forms. As such, they are less effective when the ship geometry has been designed correctly, with an eye at optimizing the flow to the propeller and avoiding the generation of detrimental hydrodynamic effects such as bilge vortices. The most common wake equalization and flow separation alleviating devices are Grothues spoilers, Schneekluth ducts and stern tunnels.

Grothues Spoilers

Grothues spoilers are small curved triangular plates welded at the side of the hull in front of the propeller and above the propeller axis. Their

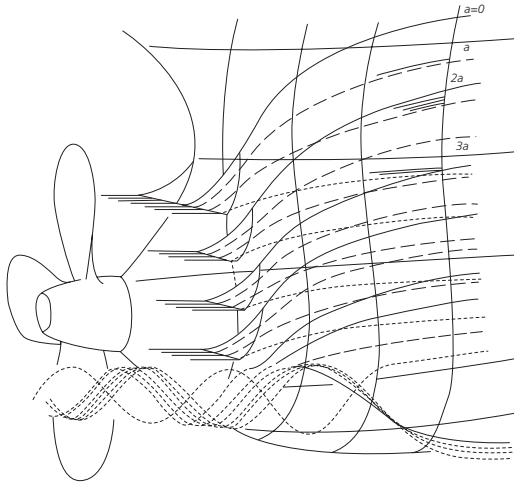

Figure 7. Grothues Spoilers Working Principle

function is to deflect downward the flow of water so that it is re-directed horizontally in towards the propeller. Grothues originally proposed them to minimize/prevent the formation of keel vortices in the U-shaped sterns of full block coefficient (C_b) ships (tankers and bulk carriers). However, tank testing provided some indication that they would also improve the efficiency of the propeller in view of the larger amount of water made available to the upper portion of the screw and lesser component of the incoming wake in the plane of the propeller disk (both wake equalization effects). In the best cases, spoilers might also provide a limited amount of additional thrust to the ship as a result of the redirection of vertical flow components in the horizontal direction.

The effectiveness of these devices depends to a large extent on the correct alignment of the inflow edge of each spoiler with the incoming flow lines, a reasonably gradual curvature of the plate that would prevent flow separation at the spoiler and a correct dimensioning and positioning of the device to maximize its benefits without unduly increasing skin friction and parasitic drag. All of this has to be achieved through flow visualization techniques (tank tests and/or CFD) but, in reality, it is hard to imagine how these ideal conditions could be maintained when the flow is disturbed by ship motion and waves. Grothues-Spork reports PD reduction values of no more than 10 percent for nonoptimized full C_b hulls. Lesser benefits should be expected for all other ship types.

Wake Equalizing (Schneekluth) Ducts

The purpose of wake equalizing ducts is similar to that of the Grothues spoilers, in the sense that both types of devices try to redirect flow to the upper

portion of the propeller disk, thus homogenizing the wake and improving hull efficiency. However, unlike Grothues spoilers, Schneekluth ducts also accelerate the flow by means of the lift created by the aerofoil shape of the duct cross-section. The latter can be designed so that it is more forgiving to variations of the angle of attack than Grothues spoilers are, thus improving the effectiveness of the device in real operating conditions. Also, the shape and dimension of the duct can be optimized to suit higher ship speeds than normally suitable for Grothues spoilers, while providing the amount of additional wake redirection required to obtain a nearly uniform wake.

Finally, the low pressure area created in front of the duct can have beneficial effects in terms of re-attaching separated flow to the hull in the vicinity of the duct. However, it is also possible that



Figure 8. Model of a Schneekluth Duct

where the flow over the stern is already attached and uniform, this same low pressure might instead increase the thrust deduction factor.

Stern Tunnels

Stern tunnels are horizontal hull appendages placed above and in front of the propeller disk that deflects water down towards the propeller. In most cases, these devices are retrofitted to reduce the wake peak effect of pronounced V-shaped sterns, thus reducing vibration. A large number of such ducts have been designed and installed on vessels precisely for this purpose.

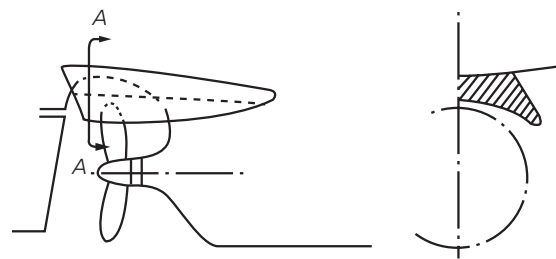

Figure 9. Partial-duct Stern Tunnel

However, in some cases, they have been used to verify that a larger diameter propeller will be properly submerged even when in ballast draft. In these cases, an overall improvement of propulsion efficiency can be obtained, but it should be noted that improper design of a stern duct can influence both skin friction and wavemaking resistance and produce significant losses of hull efficiency particularly with pronounced stern trims.

Pre-swirl Devices

Savings	2 to 6 percent reduction in propulsion fuel consumption.
Applicability	To be designed in conjunction with the propeller and any relevant post-swirl device.
Ship Type	All
New/Existing	New and retrofit
Cost	Medium-low, depending on the device.

Pre-swirl devices are hydrodynamic appendages to the hull aiming to condition the wake flow so that a rotation opposite to that of the propeller is imposed on it, thus improving the angle of attack of the flow on the propeller blades over the entire disk. Also, the pre-swirl rotating flow counteracts the rotation flow induced by the propeller. As a result, the flow leaving the propeller disc can be made to contain minimum momentum in the circumferential direction, thus requiring less kinetic energy to produce thrust.

Pre-swirl devices have been designed and installed both as retrofits to existing ships and as an integral feature of newbuildings. Normally, they can be made to work in nonoptimal flows (the ducted type in particular) but they work best in already optimal nominal wakes. In this sense, they can be considered as fully complementary to other optimization approaches with the exception of nonsymmetrical stern lines.

Pre-swirl Fins and Stators

Pre-swirl fins and stators are sets of fins arranged directly in front of the propeller around the shaft axis. The number and orientation of these fins is not always symmetrical to port and starboard, because of the uneven vertical distribution of the wake in front of the device that combines with the necessity to create an even rotational flow aft of the device and in front of the propeller. Stators can have a small nozzle ring mainly to provide



Figure 10. Stators on CMA-CGM Containership CHRISTOPHE COLOMB

greater strength to the arrangement and marginally improve efficiency.

This sort of pre-swirl design is best suited for and has been installed on faster ships with heavily loaded propellers, such as those of containerships. In these cases, there is no need to further accelerate the flow into the propeller and the required rotation can be provided with a minimal number of fins (normally three on one side and one on the other) thus limiting the added drag imposed by the system. It should be noted that these devices normally require the propeller design to be optimized to work behind the stator, so that the additional loading created by the pre-swirl flow is properly accommodated.

Pre-swirl Stators with Accelerating Ducts

Several devices including Mitsui integrated ducted propeller, Hitachi's Zosen Nozzle, Sumitomo's Integrated Lammeren Duct and Becker's Mewis Duct combine a pre-swirl stator with an accelerating duct. The duct can be non-axis-symmetric and one of its roles is that of homogenizing the axial wake component. However, the duct also increases the efficiency of the pre-swirl fins by providing a more important water inflow to the stator. In addition, the duct contributes to the total thrust by virtue of the lift created by the accelerating flow over its walls.

Integrated stator-duct devices are normally installed on full-form vessels and their design is considerably complex since each component of the hull-duct-stator-propeller assembly interacts with each other. However, it should be noted that, in general, the size of the duct should be reduced with

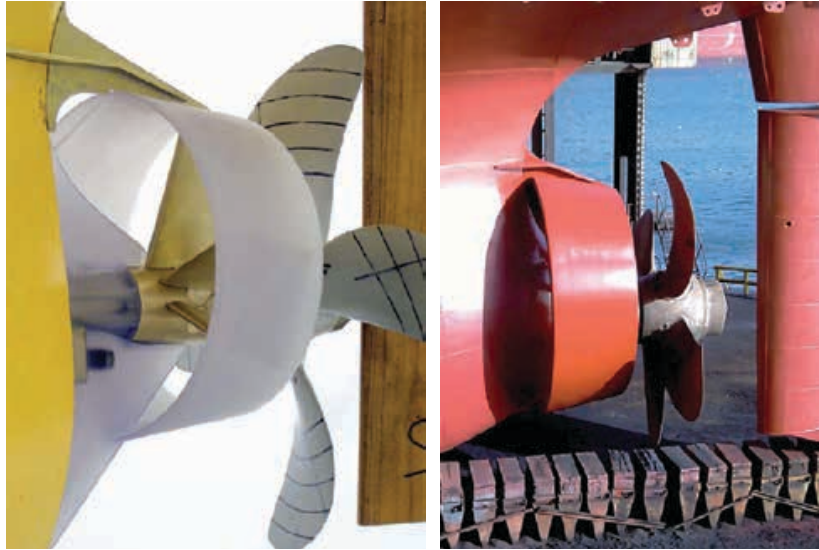

Figure 11. Becker Mewis Duct on a Bulk Carrier

it to improve rudder efficiency. In turn, this might allow the use of a smaller rudder, hence reducing overall ship resistance.

Because these devices attempt to condition the flow behind the propeller, they are almost invariably associated with the rudder design. In fact, some considerable overlaps should be expected between possible improvements in propulsion thrust and rudder efficiency benefits, so the design of the assembly should take

increasing ship speed and decreasing C_b otherwise the penalties in terms of added resistance might outweigh the propulsion efficiency gains.

both aspects into consideration.

Post-swirl Devices

Savings	2 to 6 percent reduction in propulsion fuel consumption.
Applicability	To be designed in conjunction with the propeller and any relevant pre-swirl device.
Ship Type	All
New/Existing	New and retrofit
Cost	Medium-low, depending on the device. Maintenance cost can be an issue.

Since the performance of post-swirl devices and rudders are so closely linked, it is important to verify the effectiveness of both parts and the absence of detrimental side effects for all rudder and propeller operating conditions, particularly in terms of strength and fatigue.

Post-swirl devices can be fitted in tandem with a pre-swirl setup (a notable case is the CMA-CGM containership *Christophe Colomb*). However, because the pre-swirl device would already decrease the rotational flow past the propeller, a reduced effectiveness of the post-swirl device should be expected. As with all PID's, this effect should be studied by extensive use of CFD analysis and model tests at the design stage to avoid turning an efficiency-improving device into an additional source of parasitic drag, structural and vibration problems, or both.

The role of post-swirl devices is that of conditioning the flow at the aft end of the propeller. In a number of cases, this means trying to convert the rotational components of the flow



Figure 12. Twisted Leading Hedge Rudder on the CMA-CGM Containership CHRISTOPHE COLOMB

created by the propeller to useful axial flow. In others, it is just a matter of either suppressing detrimental flow characteristics (such as the propeller hub vortex) or diverting

Rudder Thrust Fins, Post-swirl Stators and Asymmetric Rudders

All of the above devices attempt to deflect the flow from the propeller to turn its rotational components into useful axial flow. This idea comes from the stators behind the rotors of turbine engines. The concept works best when the stator is not mounted directly on the rudder, as this imposes a horizontal rotation to the stator fins in the wake behind the propeller, thus making it impossible to optimize angles of attack on the stator fins when the rudder is in use. This effect also increases the possibility of structural



Figure 13. HHI Thrust Fins

problems because of the unbalanced loading of the port and starboard blades.

In addition, thrust fins and stators are sometimes mounted on the rudder horn and can be associated with a propeller diverging cap, a Costa bulb or both. In this case, the compression of the flow created by the bulb increases (but also rectifies) the flow that hits the stator blades, thus reducing the fin size needed.

Asymmetric rudders are ones in which the aerofoil profiles of the portion of the rudder above the propeller axis and those below are optimized to work in the wake of the propeller. Because of this, asymmetric rudders often have a twisted leading edge, sometime merging in a Costa bulb just behind the propeller hub. These types of rudders also take advantage of the rotational flow behind the propeller but this effect is normally used to

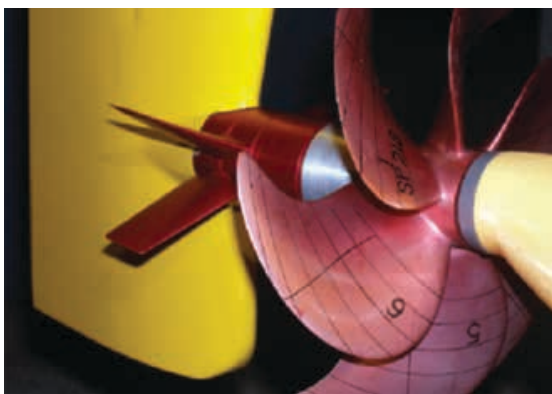

Figure 14. SHI Port-stator

improve the rudder efficiency rather than create significant additional thrust. Because of this, the rudder sections are designed to be quite forgiving in terms of angle of attack variations.

Rudder (Costa) Bulbs, Propeller Boss Cap Fin (PBCF) and Divergent Propeller Caps

This family of devices attempts to condition the radial distribution of the flow behind the propeller near the hub, to reduce the losses associated with high rotation and the creation of a strong vortex in this area. However, while the radial compression of the flow created by a PBCF device is negligible, Costa bulbs can accelerate the flow past the rudder and thus also influence its operation. In this sense, they are often used to improve rudder efficiency.



Figure 15. Wärtsilä High Efficiency Rudder

If a Costa bulb is mounted on the rudder rather than its horn, it is important to take into account the effect of rudder rotation on its efficiency and its interaction with the propeller.

Grim Vane Wheels

Grim vane wheels try to recover some of the energy associated with the rotational flow behind the propeller using it to power the turbine-shaped central part of the wheel, to drive its outer propeller portion. This type of design depends on the correct sizing of the propeller portion of the wheel so that a positive balance is struck between energy absorbed by the central portion the power developed by the outer portion and the frictional losses at the hub. This is obviously hard to do for a vast range of operating conditions. This reason,

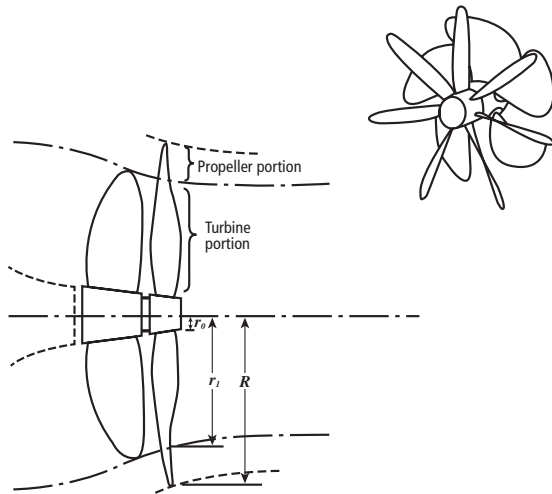

Figure 16. Grim Wheel Basic Principle

in addition to the need for the hull clearances that accommodate the wheel and the added structural and maintenance implications of its moving parts, have made this type of device a rare occurrence.

High-efficiency Propellers

Savings	3 to 10 percent reduction in propulsion fuel consumption.
Applicability	To be designed to suit the ship operational profile and stern hydrodynamic characteristics.
Ship Type	All
New/Existing	New and retrofit
Cost	Medium-low, depending on the device.

Under the umbrella of ‘high-efficiency propellers’ there are a vast number of often significantly different devices, accommodating different needs on different ship types.

Propeller Optimization

In general, larger diameter propellers with fewer blades operating at lower RPM are more efficient than smaller, faster counterparts, for a given required PE. However, this general principle is balanced by the need for reasonable propeller clearances, the nominal wake distribution behind a given hull form, and the need to match propeller and engine best performance.

This type of optimization is done routinely at the design stage, when the principal propeller

characteristics, and its detailed geometry is optimized to achieve best performance for the design speed and draft. However, there may be interest in revisiting propeller options where slow steaming is considered for a given ship on a longer term basis. In this case, the additional cost of operating the ship in off-design conditions for a long period might well justify re-examining the vessel’s propeller design.

Similarly, when examining the design of a newbuilding, it might pay off to optimize both the propeller and hull hydrodynamic performance not just for the design speed and draft, but also for those off-design conditions that the ship is most likely to encounter during its life. It has been demonstrated that optimization around the design speed and draft does not guarantee acceptable performance in off-design conditions.

Controllable Pitch Propellers (CPPs)

CPP wheels are not often seen as high-efficiency propellers. In fact, they have a significantly lower performance than fixed-pitch propellers (FPP) when used at fixed RPM in off-design conditions. The reason for this is that high RPM and small pitch values invariably create a severely sub-optimal flow over the blades with the creation of face cavitation and resulting high vibration and noise levels.

However, CPP wheels can deliver better performance than FPPs in off-design conditions when the RPM are changed to match the CPP’s best performance pitch setting. It is possible to reprogram CPP controllers to maximize the propeller efficiency in these off-design conditions. This can be valuable if a ship is likely to be operated in slow-steaming mode for portions of its life. Even when a generator is operated by drawing power from the main shaft, it is possible to vary the frequency of the current generated to allow a reduction in RPM.

Ducted Propellers

Ducted propellers are ones operating in a cylindrical duct. The cross section of the duct is an aerofoil profile and has the function of either accelerating or decelerating the flow in front of, over and behind the propeller. Decelerating ducts are rare on merchant vessels and mostly are used to control cavitation. Accelerating ducts are instead normally used to improve the propulsion characteristics of ships with low speed (most notably tugs). In these cases, a significant portion

of the thrust is generated by the lift created on the duct by the accelerating flow, but this effect is counteracted by the additional drag created by the duct itself, the latter becoming more important as the ship's speed increases.

While it is important to match the geometry of a duct to the ship's speed (shorter, smaller ducts are to be expected for faster ships), it is imperative that the propeller be optimized to operate in the flow created by the duct. In particular, it has been demonstrated that propeller tip clearance and loading have a vast effect on the efficiency of the duct.

A further use of this technology is that of steerable ducts, where the rudder is substituted by a duct that is rotated around a vertical axis in line with the propeller disk. This type of duct is limited by the maximum steering angle at which the duct can be efficiently operated and it has generally been replaced by standard ducted propellers mounted on azimuthing thrusters.

Propellers with End-plates and Kappel Propellers

Both of these propeller types have modified blade tip geometries aimed at reducing or suppressing the tip vortex and improving the overall propeller efficiency. The main difference is that while the Kappel propeller achieves this by bending the blade

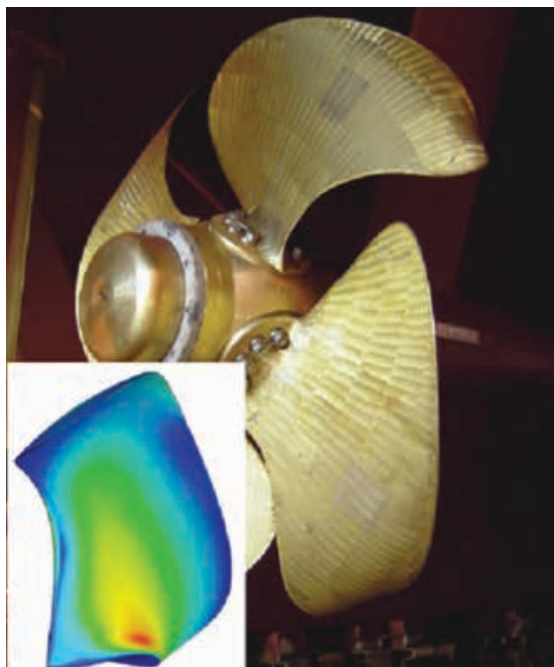

Figure 17. MAN Alpha Propellers with Kappel Blades

tip, the propeller with end-plates – also known as a concentrated loaded tip (CLT) or tip vortex free (TVF) propeller – is characterized by a wide tip chord with a thin unloaded plate at the tip extending towards the pressure side of the blade.

The idea behind such propellers is similar to that of the winglet at the end of airplane wings, with the suppression of the tip vortex permitting high blade loading in this region. Despite the considerable additional wetted area added to the propeller blades in the outer part causing strong frictional effects, large efficiency gains are claimed.

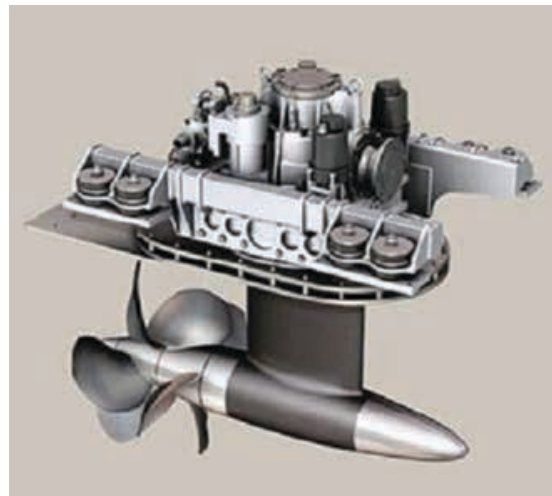

Figure 18. Contra-rotating Propellers on a Large Yacht Pod

One of the attractive features of Kappel propellers is that they are compatible in principle with a number of other efficiency-saving devices and are available both on FPP and CPP wheels.

Contra-rotating and Overlapping Propellers

Contra-rotating and overlapping propellers have the potential to increase the propulsion efficiency by exploiting the rotational flow of the upstream propeller as a way to condition the wake in front of the downstream propeller, similar to pre-swirl rotors. The difference between contra-rotating and overlapping propellers is that in the latter setup, the two propellers do not share the same axis. Although this characteristic simplifies considerably the shaft mechanics, it imposes significantly unbalanced wake over the downstream propeller. For this reason, overlapping propellers are rarely used in practice.

Contra-rotating propellers have historically been used when the rotational forces of a single propeller needs to be balanced as is the case

for torpedoes. However, owing to the complex mechanical arrangements of the shaft, contra-rotating propellers have not been used extensively on merchant ships but recently they have been applied on some types of azimuthing and podded propulsors. Because upstream and downstream propellers in a contra-rotating arrangement operate in significantly different flows, their geometry is significantly different, including the number of blades which is designed to avoid undesirable vibration harmonics effects.

Podded and Azimuthing Propulsion

The idea behind podded and azimuthing thrusters is that of combining steering and propulsion functions to obtain better characteristics for both. Undeniably, extremely large gains have been achieved by this type of technology in terms of maneuverability, but their utilization is still restricted to niche market sectors, partly because the gains in efficiency achieved by eliminating the need for a rudder have been offset by the higher cost of these plants, the limited power available for each unit, and a certain number of technical problems linked to their complexity.

The main difference between pods and azimuthing thrusters is that in podded propulsors the propeller is powered by an electric motor located in the pod immediately in front or behind the screw, while in azimuthing thrusters, the propeller is powered by an L or a Z shaft line, with the engine/motor located inside the ship.



Figure 19. Large Pod Propulsion on a Passenger Ship

While pods have been used extensively during the last decade on large passenger ships and ferries, azimuthing thrusters have mostly been used on offshore floating installations and tugs. Since azimuthing thrusters normally work in nearly bollard pull conditions, they often adopt a ducted propeller.



Figure 20. Veth Azimuthing Thruster

Skin Friction Reduction

Viscous resistance accounts for the great majority of the resistance of a hull moving through water. This is particularly true for slower ships, where the wavemaking resistance is small both in percentage of the total, and in absolute terms. However, even for faster ships (where wavemaking resistance can account for some 30 percent of the total or more) reducing viscous resistance is still extremely attractive since this force increases with the square of the ship speed, thus becoming the source of an important portion of the total power consumption of a ship.

By far the largest component of viscous resistance is skin friction. This simply depends on the ship's wetted surface, and the way it drags the water in touch with it and in its immediate surroundings, as the ship moves through it. To some extent, skin friction can be reduced by three methods: reducing the wetted surface (linear reduction), reducing speed (quadratic reduction) or improving the way the wetted surface interacts with the fluid it is in touch with. Reducing the speed and/or wetted surface are by far the easier and more effective ways to reduce skin friction. However, they both significantly affect ship operability. For this reason, a large amount of development has been dedicated through the years to improving hull-fluid interaction, either by changing the way fluid behaves (through its density, viscosity and boundary layer growth) or by improving the wetted area surface texture so that it would offer the best interaction with such fluid.

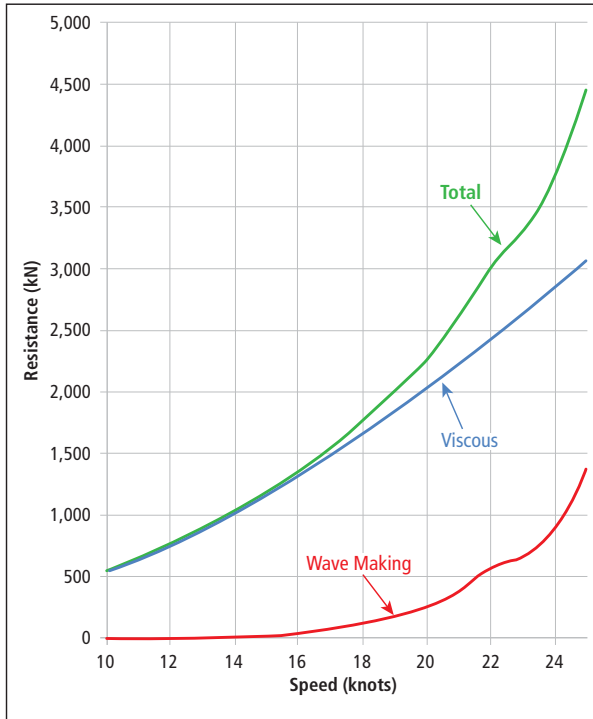

Figure 21. Typical Resistance Curve for a Large Commercial Vessel

Most of wetted surface conditioning on merchant vessels is done through the use of paints. These are designed to minimize the growth of marine life on the hull and, normally, to render its surface smooth. In this section, standard marine coatings will not be addressed, but rather a look at some more recent trends in research showing that a smooth surface is not necessarily the best in terms of skin friction reduction. In addition, the Advisory includes several proposals (some still in the research stage) that claim to significantly reduce skin friction by use of air lubrication. The latter technique can be seen either as an attempt to reduce the wetted surface or as an attempt to improve the fluid viscous characteristics.

Air Lubrication

Savings	Up to 10 percent reduction in propulsion fuel consumption.
Applicability	Still unproven technology under research for commercial use.
Ship Type	In principle, all ship types but practical applicability is still poorly understood.
New/Existing	Generally new ships only. Retrofits are possible but can be very costly.
Cost	Medium to large. Maintenance cost unknown.

Air lubrication should not be confused with other similar methods to separate the wetted surface from water, such as air-cushioning (as used on hovercrafts and surface effect ships or SESs). The general idea is similar, but in air lubrication the attempt is to minimize the power needed to force air to stay in touch with those parts of the hull that would normally be in contact with water. This would make the technology attractive not just for very high-speed craft but for all vessels.

There are two main types of air lubrication. In air cavity systems, a thin sheet of air is maintained over the flat portions of a ship's bottom with the aid of pumps and hull appendages. In ideal conditions, this effectively amounts to a reduction in the wetted surface at the expense of the power needed to supply the pumps and the added resistance due to the hull modifications. An alternative method is that of effectively reducing the density and improving the viscous behavior of the water in contact with the hull by mixing it with air in the form of micro-bubbles.

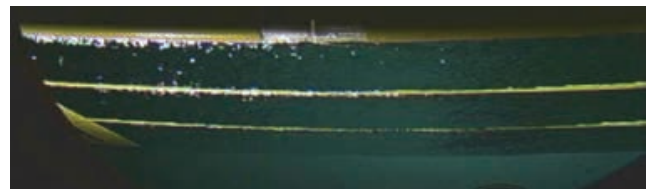

Figure 22. Bottom of an Air Cavity Barge Tested at SSPA

Air Cavity Systems

In air cavity systems, a thin layer of air is formed and maintained over the flat bottom of the hull. When a stable layer can be maintained (typically for small Froude numbers) significant reductions in skin friction can be achieved, roughly linearly proportional to the decrease in wet surface area obtained. However, with speed increasing, the stability of the air cavity becomes more and more difficult to maintain. When the stability of the air cavity breaks down, an actual increase in the overall resistance of the ship through water is observed. This effect, of course, is exacerbated by a ship's motion in a seaway.

Micro-bubbles

Maersk has recently devoted significant efforts to explore the viability of micro-bubble air lubrication. According to the *Naval Architect*, the company funded extensive tank testing at



Figure 23. OLIVIA MAERSK Showing Wing Air Induction Pipe Micro-bubble Units Staggered Over its Side

MARIN, and also installed a prototype system on one of their vessels in an attempt to verify in what conditions this methodology could be made to work. To date, the results of such research seem not to have shown any significant breakthrough.

The attractiveness of micro-bubble systems is that one does not need to ensure stability in the flow of air over the hull as in the case of an air cavity. Also, the amount of power needed to create micro-bubbles would be lower than that needed for a cavity, and the amount of wetted surface treated larger, since micro-bubbles can be created anywhere over the hull instead of just over the flat of bottom. However, the Maersk-MARIN experience seems to indicate two main problems with this methodology. First, it is not possible to produce a sufficient quantity of the correct micro-bubble size in full scale and maintain it for a long stretch of their path over the hull, as the bubbles expand and merge together. This severely reduces the skin-friction reduction capabilities of the air/water mixture. Subsequently, it is very hard to get the air/water mixture to remain in contact with or sufficiently close to the hull once the micro-bubbles leave their outlets.

Hull Surface Texturing

Savings	Unknown. Not likely more than 5 to 10 percent reduction in propulsion fuel consumption.
Applicability	Still unproven technology (under research).
Ship Type	In principle, all ship types but practical applicability still poorly understood.
New/Existing	New and retrofit
Cost	Expected to be medium-low. Maintenance cost unknown.

One method to reduce skin friction is to alter the way flow velocity grows through the boundary layer and/or the way the boundary layer grows along the hull. This depends in a complex way on ship speed and the geometrical characteristics (on all scales) of the hull. In general, a smooth hull surface is considered to be conducive of best performance and, to a large extent, this is the case when the alternative is a fouled hull as a consequence of marine growth. However, it has been demonstrated that some further benefits can be achieved by adopting particular types of surface texturing in place of a uniformly smooth hull. More specifically, the presence of riblets and semi-spherical microcavities of certain sizes can distort the flow through the boundary layer and thus reduce skin friction.

This type of technology is still in its infancy and it is unclear how the correct shape and size of texture can be achieved and maintained on a ship's hull. However, some paints are being developed that might be able to achieve this in the future.

Renewable Energy

The utilization of renewable energy sources is currently benefiting from vast international attention in many industrial fields, including shipping. In our industry, attempts in this direction are naturally concentrating on wind power, since it is readily available at sea and has a history of successful use. However, photovoltaic (PV) solar panels are also being considered in specific fields such as the generation of auxiliary power.

Wind

Savings	Up to 30 percent reduction in propulsion fuel consumption but overall performance depends strongly on the ship's operational profile.
Applicability	Technology coming into maturity. Applicability limited by ship superstructures and operational profiles.
Ship Type	All slow-speed ship types. Deck arrangements and utilization can severely limit the practical applicability of some devices.
New/Existing	New and retrofit
Cost	Medium. Maintenance cost still unknown.

Wind has been used to propel ships for the millennia, but the vast practical benefits of modern propulsion systems have meant the progressive decline and disappearance of sails from all merchant vessels. The feasibility of returning to sails needs to be integrated with the complexity of operation imposed by this type of propulsion. However, the large fuel-saving benefits that wind power can provide should not be underestimated.

Wind power seems to be reasonably easy to achieve in an effective way. Unfortunately, the technology commercially available at present is not advanced enough to achieve this aim. However, significant progress has been made during the last few years and it is reasonable to expect further improvements in the short term. In the following, the most promising technologies under development are discussed.

Towing Kites

Towing kites are currently the only wind power technology commercially available to ships. The principle behind it is relatively simple, although the technology necessary to deploy, control and recover the kite is rather complex. In practice, extra power is provided to propel the ship by flying a kite tethered to the vessel's bow. The kite speed through the air increases its efficiency compared to standard sails but the setup requires a computer to control the kite.

TU Delft and MARIN estimate that large fuel savings are possible using these systems for slower ships (typically bulk carriers and tankers), however the envelope of operability of kites is limited to a relatively narrow range of wind conditions (essentially quartering winds), which further limits

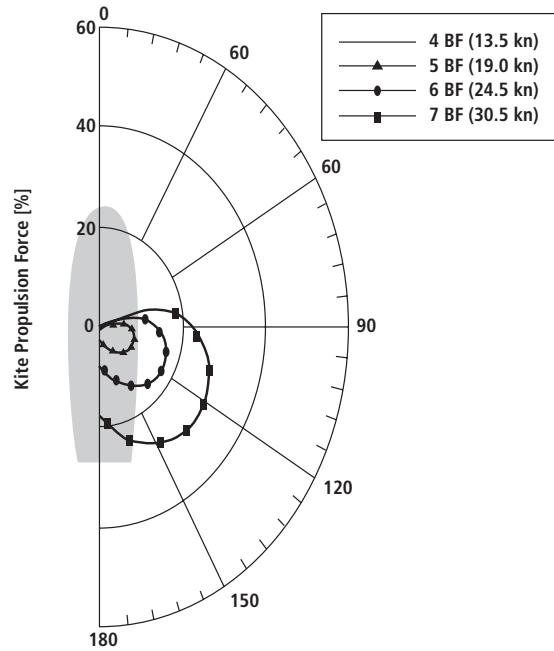

Figure 25. Relative Kite Propulsion Polar Plot

the usefulness of these systems. In order to evaluate the actual cost-benefit of kites, it is therefore necessary to estimate their potential when deployed on specific routes where wind patterns can be predicted.

The real concern regarding towing kites is on the complexity of its operation and the risk associated with the system behavior in rough weather. As the largest gains provided by towing kites are when strong tail winds are present, it is paramount that the system can be operated safely, reliably and with no additional strain of the already limited crew resources available on board.

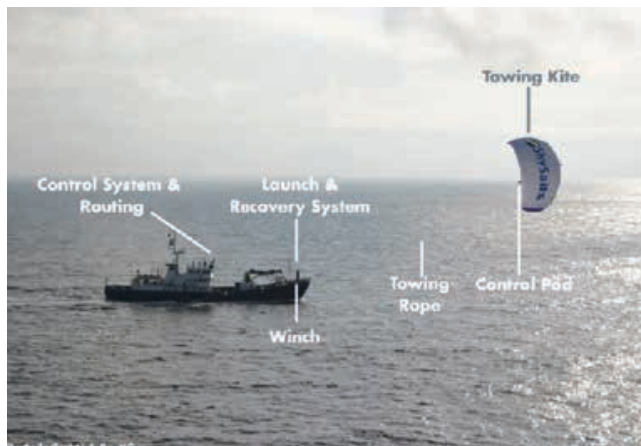

Figure 24. Towing Kite System on the MS BEAUFORT

Rotor Sails, Flettner Rotors and Windmills

Flettner rotors are vertical, cylindrical sails spinning around their axis. A propulsive force is generated in the direction perpendicular to that of the wind hitting the rotor as a result of the Magnus effect. For this reason, rotor sails offer maximum efficiency near apparent beam wind conditions, a characteristic that could make them interesting as a complement to towing kites.

However, rotors are normally powered by a diesel engine driven motor to achieve the necessary RPM. Also, unless they



Figure 26. Flettner Rotors on ENERCON E-Ship 1

are made to telescopically collapse onto the deck to minimize aerodynamic drag when they are not in use, they might increase fuel consumption for a large range of wind directions. For these reasons, it is unclear if the overall

efficiency of these systems can offer them a realistic chance of commercial success.

An alternative to powering the rotors using engines is the use of vertical axis (Savonius) wind turbines or VAWTs. They show some degree of autorotation as a result of the Magnus effect like Flettner rotors, but rotate simply as the result of wind hitting the blades. The other advantage of VAWTs is they can be made to power electrical generators, thus obviating to the limitation of standard Flettner rotors when the wind is from the stern. To this day, limited research is available on the onboard use of these devices, though, making it hard to assess their feasibility in practice.



Figure 27. Vertical Axis Wind Turbine

Turbosail

Turbosails were first proposed by Jacques-Yves Cousteau, Bertrand Charrier and Lucien Malavard as a way to significantly improve the efficiency of standard sails, thus limiting the size needed to power a vessel and their heeling effect. The principle is to use a fan at the top of a hollow vertical cylinder to extract air from it. Inlets on the downwind side of the sail would then be opened to create a large depression and significantly increase lift.



Figure 28. Turbosails on the ALCYONE

Turbosails were fitted on the *Alcyone* and operated in parallel with two standard diesel engines. An automatic system regulates the operation of the sails fan and the standard propulsion to optimize performance. Although this system is an interesting way to re-introduce wind propulsion in the modern shipping industry, very little public data is currently available on its actual performance.

Solar

Savings	Marginal fuel reduction
Applicability	Mature technology but applicability very limited.
Ship Type	All
New/Existing	New and retrofit
Cost	Medium. Maintenance cost can be an issue.

There have been attempts to use PV panels to power small craft, such as the 30-m long catamaran *Planet Solar*, designed to circumnavigate the world on a 500 m² array. However, because of the low electrical output per unit surface, PV solar panels are better suited as an additional source of auxiliary power. In this role they have already been utilized on commercial vessels such as the NYK car carrier *Auriga Leader*, equipped with 328 solar panels

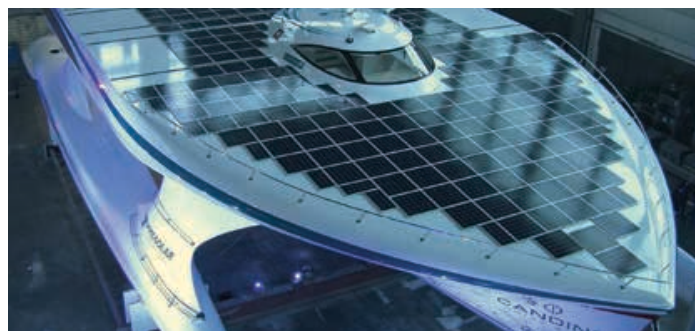

Figure 29. PLANET SOLAR

at a cost of \$1.68 million. The energy generated by the 40 kW solar array on this ship is used to power lighting and other applications in the crew's living quarters.

The obvious drawback of PV solar power is the high capital cost of these plants that have not yet benefited from large scale economies. It is to be hoped that as other land-based applications increase demand for this type of technology, the wider application in the shipping industry will be made viable.

Compatibility

The devices presented in the Renewable Energy section are not always compatible with each other and might only be feasible for specific ship types or designs. In this part, an attempt is made to give guidance on the general applicability of each device. In reading the following, the reader should bear in mind that the stated compatibilities should always be verified by means of appropriate model tests or CFD analysis, since the correct functioning of nearly all of the above measures is strongly dependent on having a good understanding of the way they will interact with a given specific design.

Ship Design Characteristics/Ship Type

In general terms, the applicability of renewable energy devices is not dependent on the ship type as such (tanker versus bulk carrier, for instance), as it is on specific design characteristics. For instance, wind power is generally only useful for slower vessels, as the envelope of useful wind speeds becomes narrower and narrower as the apparent wind changes with ship speed. Similarly, the deck arrangement will also affect the feasibility of sails and kites, making all of these unsuitable for ships such as container carriers or offshore support vessels (OSVs).

In Figure 31, an overview is given of the typical ship designs that are compatible with each energy-saving device presented in the foregoing. It should be noted that in putting together this table, typical design characteristics were assumed for each type. For instance, oil tankers and bulk carriers are considered as full block ships with U-shaped sterns which are more likely to benefit from devices that correct the typical hydrodynamic problems of this kind of hulls, such as bilge vortices. Similarly, OSVs and tugs are considered as representative of ships that do not have an



Figure 30. AURIGA LEADER

operational profile such that a constant speed is maintained for the majority of the ship's life.

In other cases, the ship design distinctions are more difficult to generalize, but it can be assumed that the container ships, passenger ships and gas carriers are fast ships with relatively low block coefficients. However, the typical deck characteristics of container ships distinguish this type from the others considerably.

Of course, given the large variation in actual ship designs, the above generalizations are perhaps not very useful. In this sense, it is important to realize that design variations common to many ship types cannot be captured. Of these, the most obvious is probably the stern arrangement (single screw versus twin screw, but also the shape and clearances of the portion of the stern above and in front of the propellers).

Mutual Compatibility

In his overarching report on PIDs, John Carlton states: "In many cases it is asked whether the various energy-saving devices are compatible with each other so as to enable a cumulative benefit to be gained from fitting several devices on a ship. The general answer to this question is no, because some devices remove the flow regimes upon which others work; however, several of the devices can be used in combination in order to gain a greater benefit." Figure 31 outlines this compatibility relationship, extended, as appropriate, to the energy-saving devices identified.

Figure 32 summarizes the mutual compatibility of PIDs. It should be noted that, to a large extent, both skin friction reduction methods and wind power devices are considered to be compatible with all of the identified PIDs and with each other. However, for the most part,

such interactions are not verified nor can they be dismissed a priori. For instance, MARIN estimates that the use of wind kites generally improves ship performance not only directly (adding wind energy to the ship overall balance) but also by

enhancing the flow over the propeller. Similarly, all air lubrication technology presents the obvious inherent risk of negatively affecting propulsion by venting the screw, unless appropriate provisions are made to avoid this.

Ship Type Compatibility

	Tankers Bulkers	General Cargo	Contain- ships	Passenger Ships	RORO/Car Carriers	ROPax	Gas Carriers
Wake-equalizing, Flow Separation Alleviating Devices							
Grothues Spoilers	✓						
Schneekluth Ducts	✓	✓	✓				
Stern Tunnels		✓	✓				
Pre-swirl Devices							
Pre-swirl Fins and Stators	✓	✓	✓	✓	✓	✓	✓
Mitsui Integrated Ducted Propeller	✓	✓	✓	✓	✓	✓	✓
Hitachi Zosen Nozzle	✓	✓	✓	✓	✓	✓	✓
Sumitomo Integrated Lammeren Duct	✓	✓	✓	✓	✓	✓	✓
Becker Mewis Duct	✓	✓	✓	✓	✓	✓	✓
Post-swirl Devices							
Rudder Thruster Fins	✓	✓	✓	✓	✓	✓	✓
Post-swirl Stators	✓	✓	✓	✓	✓	✓	✓
Assymmetric Rudders	✓	✓	✓	✓	✓	✓	✓
Rudder (Costa) Bulb	✓	✓	✓	✓	✓	✓	✓
Propeller Boss Cap Fit (PBCF)	✓	✓	✓	✓	✓	✓	✓
Divergent Propeller Caps	✓	✓	✓	✓	✓	✓	✓
Grim Vane Whels	✓	✓	✓	✓	✓	✓	✓
High-efficiency Propellers							
Large Diamter/Low RPM	✓	✓	✓	✓	✓	✓	✓
Controllable Pitch Propellers (CPP)	✓	✓	✓	✓	✓	✓	✓
Ducted Propellers	✓	✓					
Propellers with End Plates	✓	✓	✓	✓	✓	✓	✓
Kappel Propellers	✓	✓	✓	✓	✓	✓	✓
Contra-rotating Propellers				✓			
Podded and Azimuthing Propulsion				✓		✓	
Skin Friction Reduction							
Air Cavity Systems	◆	◆					
Micro Bubbles	◆	◆	◆	◆	◆		◆
Renewable Energy							
Towing Kites	+	+					
Flettner Rotors	+	+					
Windmills	+	+					
Turbosail	◆	◆					

Legend

✓	Mature/proven technologies with documented service experience
+	Technologies with near-term applicability (those with demonstrated effectiveness through CFD and model tests, but lack service experience.)
◆	Technologies needing further development

Figure 31. Ship-type Compatibility

Device Compatibility

Wake-equalizing, Flow Separation Alleviating Devices	Grothues Spoilers	Schneekluth Ducts	Stern Tunnels	Pre-swirl Devices	Mitsui Fins and Stators	Hitachi Zosen Nozzle	Sumitomo Integrated Lammeren Duct	Becker Mewis Duct	Post-swirl Devices	Rudder Thruster Fins	Post-swirl Stators	Asymmetric Rudders	Rudder (Costa) Bulb	Propeller Boss Cap Fit (PBCF)	Divergent Propeller Caps	Grim Vane Whels	High-efficiency Propellers	Large Diameter/Low RPM	Controllable Pitch Propellers (CPP)	Ducted Propellers	Propellers with End Plates	Kappel Propellers	Contra-rotating Propellers	Podded and Azimuthing Propulsion	Skin Friction Reduction	Air Cavity Systems	Micro Bubbles	Renewable Energy	Towing Kites	Flettner Rotors	Windmills	Turbosail			
Grothues Spoilers									C	C	C	C	C	C	C	C	C	PC	C	C	C	C			C	C	C	C	C	C	C	C	C	C	
Schneekluth Ducts									C	C	C	C	C	C	C	C	C	PC	C	C	C	C			C	C	C	C	C	C	C	C	C	C	C
Stern Tunnels									C	C	C	C	C	C	C	C	C	C	C	C	C	C			C	C	C	C	C	C	C	C	C	C	C
Pre-swirl Fins and Stators									C	C	C	C	C	C	C	C	C	PC	C	C	C	C			C	C	C	C	C	C	C	C	C	C	C
Mitsui Integrated Ducted Propeller									C	C	C	C	C	C	C	C	C	PC	PC	PC	PC			C	C	C	C	C	C	C	C	C	C	C	C
Hitachi Zosen Nozzle									C	C	C	C	C	C	C	C	C	PC	C	C	C			C	C	C	C	C	C	C	C	C	C	C	C
Sumitomo Integrated Lammeren Duct									C	C	C	C	C	C	C	C	C	PC	PC	PC	PC			C	C	C	C	C	C	C	C	C	C	C	C
Becker Mewis Duct									C	C	C	C	C	C	C	C	C	PC	PC	PC	PC			C	C	C	C	C	C	C	C	C	C	C	C
Rudder Thruster Fins									C	C	C	C	C	C	C	C	C	PC	PC	C	C			C	C	C	C	C	C	C	C	C	C	C	C
Post-swirl Stators									C	C	C	C	C	C	C	C	C	PC	C	C	C			C	C	C	C	C	C	C	C	C	C	C	C
Asymmetric Rudders									C	C	C	C	C	C	C	C	C	PC	C	C	C			C	C	C	C	C	C	C	C	C	C	C	C
Rudder (Costa) Bulb									C	C	C	C	C	C	C	C	C	C	C	C	C	PC		C	C	C	C	C	C	C	C	C	C	C	C
Propeller Boss Cap Fit (PBCF)									C	C	C	C	C	C	C	C	C	C	C	C	C			C	C	C	C	C	C	C	C	C	C	C	C
Divergent Propeller Caps									C	C	C	C	C	C	C	C	C	C	C	C	C	PC		C	C	C	C	C	C	C	C	C	C	C	C
Grim Vane Whels									C									PC	PC	PC	PC			C	C	C	C	C	C	C	C	C	C	C	C
Large Diameter/Low RPM									C									PC	PC	C				C	C	C	C	C	C	C	C	C	C	C	C
Controllable Pitch Propellers (CPP)									C									C	C	C				C	C	C	C	C	C	C	C	C	C	C	C
Ducted Propellers									C									PC	PC	C	C			C	C	C	C	C	C	C	C	C	C	C	C
Propellers with End Plates									C													C		C	C	C	C	C	C	C	C	C	C	C	C
Kappel Propellers									C													C		C	C	C	C	C	C	C	C	C	C	C	C
Contra-rotating Propellers									C													C		C	C	C	C	C	C	C	C	C	C	C	C
Podded and Azimuthing Propulsion									C													C		C	C	C	C	C	C	C	C	C	C	C	C
Air Cavity Systems									C															C	C	C	C	C	C	C	C	C	C	C	C
Micro Bubbles									C															C	C	C	C	C	C	C	C	C	C	C	C
Towing Kites									C															C	C	C	C	C	C	C	C	C	C	C	C
Flettner Rotors									C															C	C	C	C	C	C	C	C	C	C	C	C
Windmills									C															C	C	C	C	C	C	C	C	C	C	C	C
Turbosail									C															C	C	C	C	C	C	C	C	C	C	C	C

LEGEND

C The devices are theoretically fully compatible with each other

PC The devices are partially compatible and overall efficiency is not fully additive

Figure 32. Device (PID) Compatibility

Section 3

Structural Optimization and Light Weight Construction

Introduction

Structural weight reductions have a great effect on required power for faster and smaller vessels like fast ferries. Structural weight optimization for large cargo vessels (displacement hulls) increases the available deadweight for a ship of the same size, thereby improving transport efficiency. For high-speed craft, reducing the lightship through the introduction of nonferrous materials is necessary to satisfy mission requirements, and can have significant impact on fuel consumption.

This section discusses the current practice on use of higher strength materials on cargo ships, and to what extent the reduced lightship translates into improved fuel consumption. The contents of this section are as follows:

Use of Higher Strength Steel (HTS)

- Tankers
- Bulk Carriers
- Containerships

Weight Savings from the Use of HTS

Potential Impact of HTS on Payload

Potential Impact of HTS on Fuel Consumption

Composites and Other Nonferrous Materials

Use of Higher Strength Steel (HTS)

Savings	10 percent additional HTS can reduce steel weight by 1.5 percent to 2 percent. For deadweight limited ships, a 0.2 to 0.3 percent increase in deadweight and cargo payload is realized. Alternatively, fuel consumption per tonne cargo transported can be reduced 0.2 to 0.5 percent.
Ship Type	All
New/Existing	New
Cost	Construction cost decreases with increased HTS, as cost savings from reduced steel weight more than offsets any incremental cost for HTS versus mild steel.

Judicious use of HTS is an appropriate and effective means for reducing weight and cost. If the block coefficient is adjusted accordingly, a nominal reduction in fuel consumption is realized. For deadweight limited vessels such as tankers and bulk carriers, if the block coefficient is held constant, there is a corresponding increase in deadweight.

Tankers

Figure 33 shows the historical data for the percentage of higher strength steel in tankers. The solid points represent tankers built in the last decade.

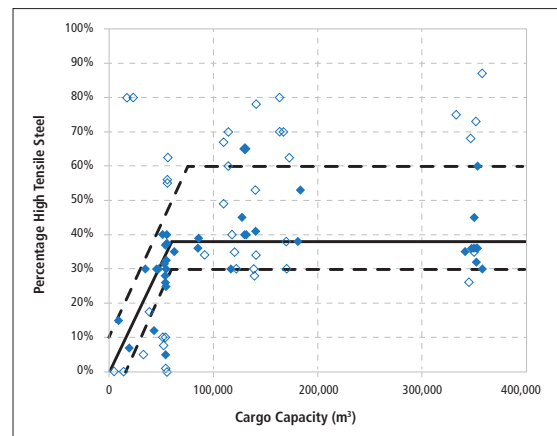

Figure 33. Tankers: HTS as a Percentage of Hull Steel

The use of higher strength steel as a percentage of total hull steel varies from 0 percent (100 percent mild steel construction) up to designs with 80 percent HT36 steel. Common practice in recent years is to build tankers in the panamax to VLCC size range with 30 to 60 percent HT32 steel, with the HT32 steel primarily applied in upper and lower longitudinally continuous hull girder structure within the cargo block, and to a lesser extent in the transverse bulkheads within the cargo region. For tankers with 50 to 65 percent HTS, the HTS is applied throughout the side shell and longitudinal bulkheads. For tankers with 70 percent HTS or more, HTS is applied over the majority of the oil tight transverse bulkheads and to a limited extent into the fore and aft body.

Bulk Carriers

Figure 34 shows historical data for the percentage higher strength steel in bulk carriers built during the last ten years.

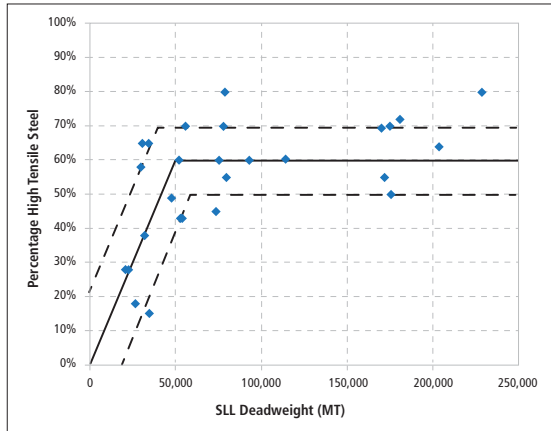

Figure 34. Bulk Carriers: HTS as a Percentage of Hull Steel

The use of higher strength steel as a percentage of total hull steel varies from 0 percent (100 percent mild steel construction) up to designs with 80 percent higher strength steel. Common practice in recent years is to build most bulk carriers with 50 to 70 percent high strength steel, with HT36 steel primarily applied in upper and lower longitudinally continuous hull girder structure within the cargo block, and to a lesser extent in the transverse bulkheads within the cargo region. HT32 steel is generally applied in the side shell, longitudinal bulkheads or upper wing tank and hopper bulkheads, inner bottom, and transverse floors, and transverse bulkheads, when HT36 is not used. Bulk carriers typically have higher percentages of high-strength steel than either tankers or containerships.

Containerships

Figure 35 shows historical data for the percentage higher strength steel in containerships. The solid points represent ships built in the last decade.

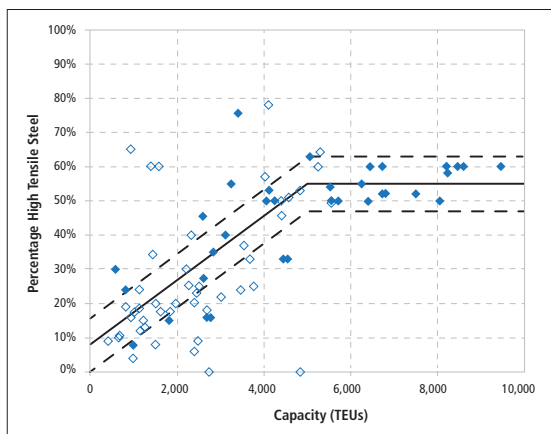

Figure 35. Containerships: HTS as a Percentage of Hull Steel

The use of higher strength steel as a percentage of total hull steel varies from 0 percent (100 percent mild steel construction) for small vessels up to designs with about 65 percent HT36 steel. Only a few ships are over that level. Common practice in recent years is to build containerships in the post-panamax size with 45 to 65 percent high tensile steel, with the HT36 steel primarily applied in upper and lower longitudinally continuous hull girder structure within the cargo block, and to a lesser extent in the transverse bulkheads within the cargo region.

Some HT32 steel is used for side shell, longitudinal bulkheads, inner bottom structure, and in transverse bulkheads and midcell structures in regions of high shear stress. HT40 or HT47 steel may be used for longitudinal hatch coaming of large container carriers. HTS is also applied on certain outfit items such as the girders and cover plates of hatch covers. Smaller containerships (less than panamax) will have lesser amounts of high strength steel, only applied in the primary upper and lower longitudinally continuous hull girder structure within the cargo block.

Weight Savings from the Use of HTS

Figure 36 shows approximate weight savings through use of higher strength steel on tankers. Substantial weight savings are realized up through 60 percent HTS. Above 60 percent HTS, the benefits of using HTS diminish. For the remaining mild steel plate, strength is no longer the dominant factor governing scantlings with buckling and corrosion margins mitigating the benefits of HTS application. Bulk carriers and tankers show similar behavior. There is little benefit through further application of HTS above 80 percent of total steel weight.

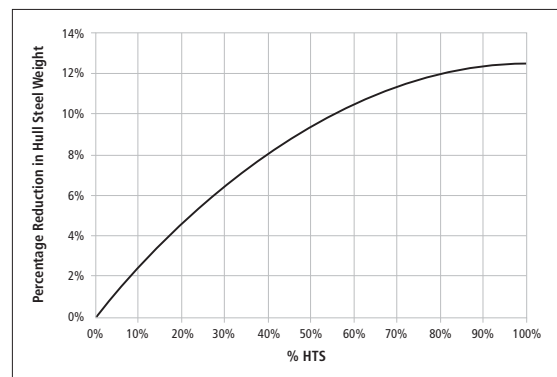

Figure 36. HTS Percentage of Weight Savings

Potential Impact of HTS on Payload

In addition, Figure 36 indicates that a 10 percent increase in HTS reduces steel weight by 1.5 to 2 percent. For deadweight limited ships such as oil tankers and bulk carriers, this leads to a 0.2 to 0.3 percent increase in payload and therefore a corresponding reduction in fuel consumption per tonne cargo transported.

Potential Impact of HTS on Fuel Consumption

To gain an understanding of the impact of decrease light ship steel weight on fuel consumption, a 1 percent reduction in hull steel weight was assumed for each ship in a set of standard designs. The block coefficient (Cb) is adjusted such that the deadweight is maintained constant. As shown in Tables 3 and 4, a 1 percent reduction in hull steel weight reduces fuel consumption by 0.11 to 0.34 percent for tankers (approximately

0.11 tonnes/day fuel savings) and by 0.23 to 0.32 percent for containerships (0.1 to 0.7 tonnes/day fuel savings). The impact of hull steel weight on CO₂ emissions is, likewise, quite small. For background on this refer to reference.

The fuel efficiency improvements gained by reducing the block coefficient are relatively small. Instead of reducing the block coefficient on deadweight limited vessels, steel weight reduction is used to increase deadweight and therefore cargo payload. HT32 grade steels are most widely used for current commercial vessels. Application of higher strength steels such as HT36 and HT40 will further decrease the lightweight of vessels. HT47 steels can be applied to hatch coaming structures of large container carriers for further structural weight optimization.

When using HTS the average stress and stress ranges experienced by the structural details increase and with that increase in stress comes a greater concern for fatigue. This should be addressed with careful attention to fatigue details during design and construction. Fatigue life of high strength steels should be controlled in proper ways including advanced fatigue and fracture mechanics analysis.

Table 3. Influence of Light Weight on Required Power: Tankers

	Panamax	Aframax	Suemax	VLCC
1% Reduction in Hull Steel (Tonnes)	101	193	258	433
% Change in Fuel Cons. for 1% Change in Steel Weight	0.34%	0.21%	0.16%	0.11%
Tonnes/day Fuel Consumption for Standard Ship	34.8	52.4	68.5	101.2
Savings (tonnes/day) for 1% Reduction in Steel Weight	0.12	0.11	0.11	0.11

Table 4. Influence of Light Weight on Required Power: Containerships

	1,000 (Feeder-ship)	4,500 TEU (Panamax)	4,500 TEU (Neo-Panamax)	8,000 TEU (Post-Panamax)	12,500 TEU (Ultra Large)
1% Reduction in Hull Steel (Tonnes)	50	191	191	318	471
% Change in Fuel Consumption for 1% Change in Steel Weight	0.32%	0.23%	0.26%	0.25%	0.24%
Tonnes/day Fuel Consumption for Standard Ship	31.3	144.4	157.8	223.3	286.7
Savings (tonnes/day) for 1% Reduction in Steel Weight	0.10	0.33	0.41	0.55	0.70

Composites and Other Nonferrous Materials

FRP laminates with light weight core material as applied to high-speed craft and superstructures offer a 30 to 70 percent weight savings. Overall, application of composites has the potential of reducing lightweight by 30 percent or more, which will translate into substantial fuel savings.

The cost of composites or aluminum structure for large cargo ships is prohibitive, and unlikely to be competitive to steel in the foreseeable future. These materials are viable for high-speed craft, and have potential applications for higher speed ferries and ro-ro/ropax vessels. Cost of construction, fire safety and recycling are the principal concerns.

Section 4

Machinery Technology

Introduction

A proper consideration of available technologies to improve the energy efficiency of main and auxiliary engines must be framed by the primary energy source – fuel. Large commercial vessels traditionally consume heavy fuel oil (HFO) also known as residual fuel oil. HFO is a byproduct of traditional refining operations and is generally very viscous containing substances that are removed from more refined (or distilled) petroleum products. Recent IMO regulations are aimed at reducing nitrogen and sulfur compounds (NO_x and SO_x) as well as CO₂ a known greenhouse gas. Reduction of CO₂ can be achieved through the reduced fuel oil consumption or greater fuel efficiency.

Reduction of NO_x is related to improvements in the combustion process. IMO has implemented a three tier regulatory scheme to reduce NO_x emissions from shipping. The first stage of NO_x reductions, known as IMO Tier I, came into effect in 2000. The next stage, IMO Tier II, became effective in 2011 and called for a 20 percent reduction from Tier I levels. The next step, Tier III, calls for even greater reductions including an 80 percent reduction from Tier I levels when operating in emission control areas (ECAs). It is envisioned that engines will need to incorporate new innovations, possibly

some sort of after treatment or cleaning system to comply with Tier III requirements. Such systems will have an adverse effect on overall efficiency.

The amount of SO_x contained in vessel emissions is directly related to the amount of sulfur in the fuel oil. IMO regulations concerning the reduction of SO_x are aimed at reducing the sulfur content of marine fuel. Implementation timelines for reduction of NO_x and SO_x is shown in Figure 37.

Companies considering the most effective strategy for complying with IMO emissions requirements will take a holistic view at their options. Reductions of NO_x and SO_x can be achieved through use of alternate fuels such as LNG or other methane products, but capital costs are significant. Lastly, use of exhaust gas cleaning systems (scrubbers) may allow operators to continue to burn fuels with higher sulfur content, but again there is an implementation cost as well as a cost to the overall system efficiency.

The remainder of this section is divided into three main subsections: Main and Auxiliary Engines; Waste Heat Recovery; and Auxiliary Machinery. Discussed in each subsection are the most practical and widely available energy efficiency measures that can be applied to that part of the machinery space. The contents of this section are as follows:

Prime Movers – Main and Auxiliary Engines

- Diesel Engine Energy Efficiency Enhancements
- Main Engine Efficiency Measurement Instrumentation
 - Main Engine Performance Measurement and Control

Waste Heat Recovery

- Exhaust Gas Heat Recovery– Steam
- Exhaust Gas Heat Recovery– CO₂

Auxiliary Equipment

- Shaft Generator
- Number/Size of Ships Service Generators
- Other Auxiliaries
- Heating, Ventilation and Air Conditioning (HVAC)
- Variable Speed Motors – Pumps and Fans

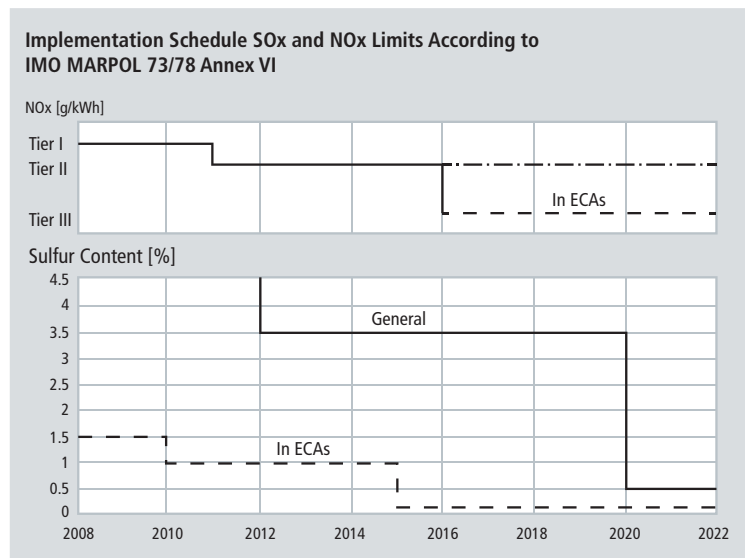

Figure 37. IMO MARPOL Annex VI Implementation Schedule

Prime Movers – Main and Auxiliary Engines

With the high cost of fuel and the regulatory efforts to reduce harmful emissions it is important that the engines operate in as efficient a manner as practical. Enhanced efficiency can be achieved via new equipment and systems or by improved operating procedures. In order to monitor how efficiently the engines are operating, and to see the effects of changes in operating procedures, it is necessary to have the right equipment installed to monitor both power output and fuel consumption. This analysis is focused on propulsion and auxiliary power systems driven by diesel engines, since this is the most common solution employed on ships.

Diesel propulsion for commercial oceangoing ships is primarily low-speed diesel engines (RPM less than 400 and crosshead type construction) and medium-speed diesel engines (RPM 400 to 1,400 and trunk piston construction). Smaller ships, tugs, ferries and high-speed craft can have high-speed diesel engines (RPM over 1,400). While these smaller vessels are not the focus of this Advisory, some of the energy efficiency measures discussed in this section can apply to them as well. Auxiliary engines used to drive generators for the ship's electrical power are most often medium-speed engines.



Diesel Engine Energy Efficiency Enhancements

This subsection will review available equipment that enhances the fuel efficient operation of diesel engines.

Diesel Engine Type for Propulsion Service

There are many reasons for selection of a specific propulsion system for a particular ship, including the size of the ship, its power relative to its draft, how many propellers are fitted, special maneuverability requirements, special operating profiles and others. Where fuel efficiency is the primary goal low-speed diesel engines would be the first choice since they have the lowest specific fuel oil consumption (SFOC) of the diesel engine choices. For low-speed diesel engines, fuel efficiency can reach up to 55 percent in the current state of technology. This means more than half the energy content of the fuel is converted to mechanical energy by the low-speed diesel engine and can be directly transmitted to the propeller.

Medium-speed diesel engines have slightly higher SFOC, which means that their efficiency is slightly lower, usually about 3 to 4 percent lower at similar power levels. Medium-speed engines must be connected to the propeller through a speed reducing transmission system – either a reduction gear or an electric drive system. When connected to the propeller through a gearbox there is about a 2 percent loss in power delivered to the propeller. When connected to the propeller through an electric drive system there is about a 10 percent loss in power delivered to the propeller.

Considering these losses in power transmission means that for the same propeller power, medium-speed diesel engines must develop about 2 percent more power in the geared design, and about 11 percent more in the electric drive design. This increase in required power coupled with the higher SFOC for medium-speed diesel engines may result in increased fuel consumption over the low-speed diesel for the same power at design condition and propeller RPM. Consideration for diesel electric systems must consider the complete energy balance of the system. Recent advances in DC grid systems are becoming increasingly relevant.

With gearing or electric drives, if the propeller RPM for the medium-speed diesel propulsion system can be reduced from the low-speed diesel system, then the potential exists to reduce the relative fuel consumption difference between the two propulsion systems due to improved propeller

efficiency. High-speed diesel engines can be used for propulsion power on high-speed craft (because of their lighter weight) and on smaller vessels. This Advisory is focused on larger, commercial-type vessels, which would use low-speed or medium-speed diesel propulsion, but some efficiency suggestions can also be applied to high-speed diesel propulsion systems.

Diesel Engine Type for Electric Power Generation

Electric power may be developed aboard ship by a generator attached to the main propulsion engine or by generators driven by independent diesel engines. The selection of the drive method will be discussed in the following section on auxiliary equipment. Whether or not the ship has a main engine-driven generator, it will still require additional generators that are normally driven by medium-speed or in some cases high-speed, diesel engines. Generators for AC power are driven at a constant speed that is found by dividing 7,200 (for 60 Hz) or 6,000 (for 50 Hz) by the number of poles (only an even number of poles are used). The larger the number of poles, results in slower generator RPM and higher costs.

Fuel efficiency of high-speed diesels is lower than medium-speed diesels, which is why medium-speed diesels are preferred where practical. Large auxiliary engines driving generators for electric drive ships

would typically operate at 514.3 RPM (14 poles/60 Hz) or 500 RPM (12 poles/50 Hz). Diesel engines providing power for ship service generators would typically have speeds between 720 and 1,000 RPM, depending on the AC frequency selected.

Electronic Control

With the advent of reliable microprocessors and computer controls, it is now possible to electronically control the fuel injection timing, fuel injection quantity and, on low-speed diesel engines, exhaust valve timing. This changes the traditional camshaft-driven fuel injection pumps and valve hydraulic pumps to high pressure common mains or rails with solenoid valves that are opened and closed by the electronic control system. The key to the functioning of the electronically controlled engine is the servo hydraulic system which powers exhaust valve operation and the fuel injection pumps. Figure 38 shows a typical hydraulic servo system for a low-speed diesel engine. The fuel is pumped up to high pressure and distributed to the fuel injector pipes by a fuel main running along the side of the engine.

Figure 39 illustrates a typical fuel injection system on the electronically controlled engine. Figure 40 shows the opening of the valves to control the exhaust valve timing and the solenoids that control the fuel injection timing and are controlled by a computer-based control system mounted on the

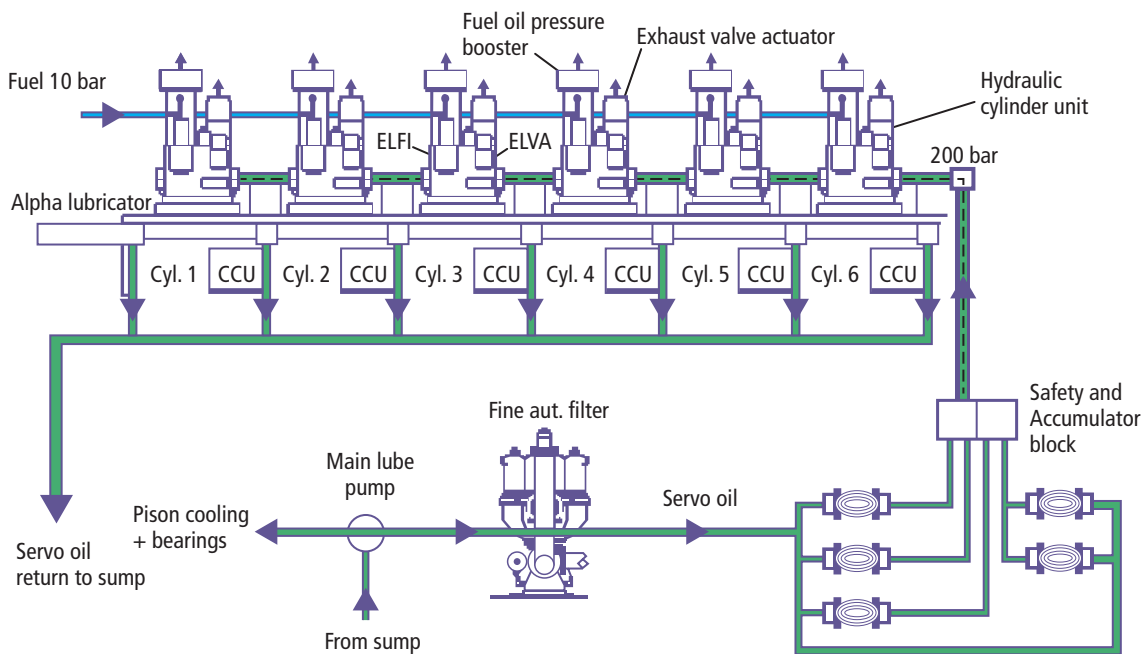

Figure 38. Electronically Controlled Engine Hydraulic Servo Oil Loop (Courtesy of MAN)

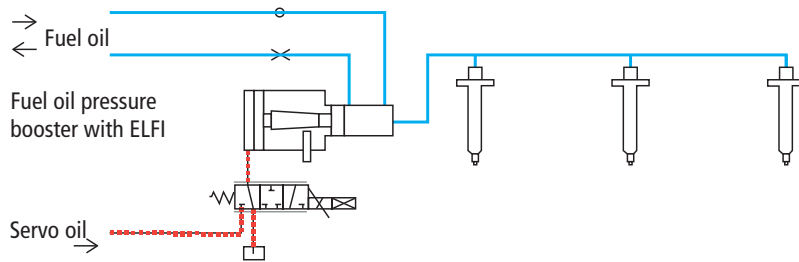

Figure 39. Injection System for Electronic Engine (Courtesy of MAN)

will increase NOx levels, so conventional Tier II compliant engines have a higher SFOC to achieve the required weighted NOx levels across the power spectrum. With electronic control it is possible to reduce NOx at lower power levels, making it possible to achieve lower overall

side of the engine. Electronic control for low-speed diesel engines (ME type engine from MAN and Flex type from Wärtsilä) results in about 2 to 2.5 percent reduction in SFOC at lower power levels than the full load operating power about which the conventional engines are normally optimized. Figure 41 shows a comparison of SFOC between a conventional engine (camshaft control of injection) and an electronically controlled engine, also referred to as a common rail engine since the fuel is supplied to the injectors from a high-pressure common rail (pipe) along the side of the engine.

SFOC while still remaining within the weighted NOx levels required for Tier II compliance. This is the primary reason that lower overall SFOC can be achieved for Tier II electronically controlled engines.

The enhanced fuel efficiency at low and medium loads is due to better control over the injection and exhaust valve timing. Electronically controlled engines can meet the MARPOL Annex VI Tier II NOx requirements with greater ease. It should be noted that methods that reduce SFOC by increasing compression and temperatures in the cylinder

For medium-speed diesel engines, electronic control of the fuel injection system similar to low-speed diesel engines is available, but control of the exhaust valves is still controlled by the camshaft. This arrangement is referred to as ‘common rail’ for medium-speed engines. Similar reductions in SFOC are applicable at medium and low loads for the same reasons as for low-speed diesels. Electronic control also provides for reduced smoke emission at low loads, which is important in ports where there are strict controls on exhaust opacity.

Automated Cylinder Oil Lubricators

Low-speed diesel engines require cylinder oil to be fed into the cylinder liners to provide lubrication of the cylinder walls and to neutralize the corrosive effects of acids in the combustion chamber formed from the sulfur content of the fuel. Traditionally this lubrication was provided by mechanical systems with individual camshaft driven piston pumps feeding lubricating quills installed around each cylinder liner. The engine makers now offer electronically controlled cylinder lubrication systems that inject controlled amounts of cylinder oil from a common high pressure oil pipe that feeds individual lubricators.

The injection of the cylinder oil from the lubricators to each lubricating quill is controlled by solenoid valves. The quantity of oil and the timing of the injection are electronically controlled and

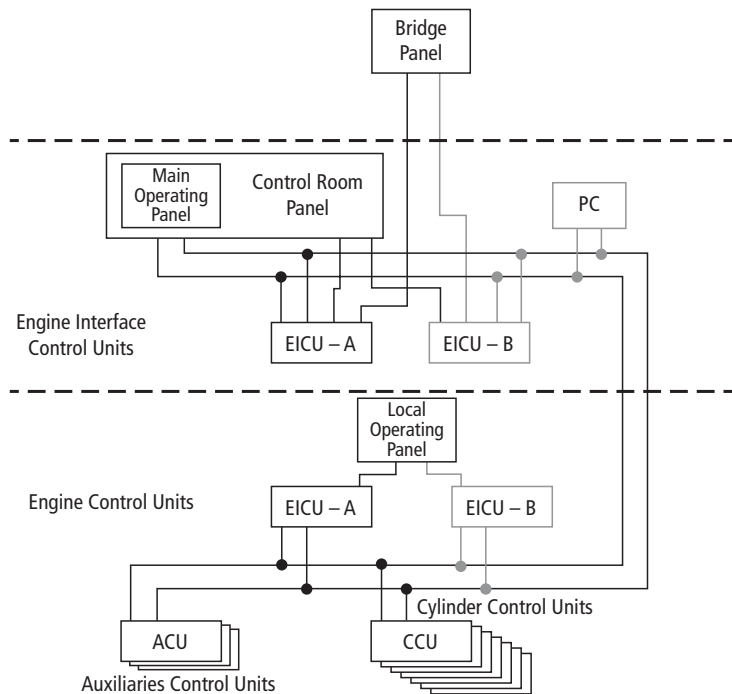

Figure 40. Control System for Electronically Controlled Engine (Courtesy of MAN)

are varied depending on engine load and can be adjusted to suit the sulfur content of the fuel.

Historically, the traditional mechanical systems provided more cylinder oil than needed to prevent periods of inadequate lubrication because of imprecise control over the timing, quantity delivered and variability in the fuel sulfur content. In traditional systems the oil quantity delivered

was also proportional to the RPM and provided too much oil at medium and low RPM versus the new systems which are load dependent (cylinder oil required is dependent on the amount of fuel entering the cylinder, which is load dependent), and provide the correct amount of oil at medium and low power levels (power reduces at a faster rate than RPM does).

Each of the major low-speed diesel engine makers has their own brand name for the automated cylinder oil lubrication systems. For MAN engines the system is called Alpha Lubricators; and for Wärtsilä it is the Pulse Lubrication System. Both systems operate on similar principles. Use of these systems can reduce cylinder oil consumption from about 1.1 g/kWh for conventional lubrication systems to 0.7 g/kWh when using one of the new systems, a 25 to 30 percent savings in cylinder oil consumption. Depending on the size of the engine, hours of operation per year and cost of cylinder oil, this can lead to annual savings of over \$100,000 per year since cylinder oil can cost as much as 20 times more per ton than fuel oil. The reduced cylinder oil consumption also reduces particulate matter (PM) emissions from the engines. The automated lubricator systems can be ordered with new engines or they can be retrofitted on existing engines. Figure 42 shows the arrangement of a typical cylinder oil lubrication system.

Lower SFOC at Reduced Load through Exhaust Gas and Turbocharger Control

For electronically controlled engines special exhaust gas and turbocharger control equipment can be installed on some low-speed diesel engines

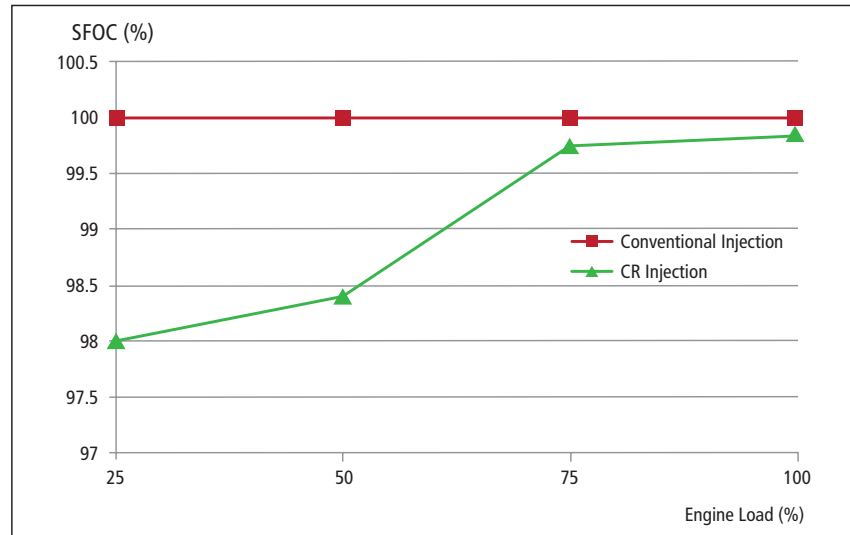

Figure 41. Reduction in SFOC due to Electronic Engine Control (Courtesy of MAN)

that will reduce SFOC at low to medium loads. This can be important for ships that will be operating consistently at less than full speed to achieve lower fuel consumption or to suit service requirements. To achieve this reduction requires special turbochargers. The system can be tuned for partial load operation (65 to 85 percent MCR) or low load operation (about 50 to 65 percent MCR). SFOC reductions of 2 to 4 g/kWh are possible. Action taken to lower SFOC will normally result in higher NOx (higher cylinder pressures and temperatures lower SFOC, but raise NOx) so Tier II NOx requirements limit possible SFOC reductions.

NOx is calculated at varying loads when meeting Tier II requirements, so the reduction in SFOC at low to medium loads, which will increase NOx at those loads, needs to be offset by a small increase in SFOC and consequential decrease in NOx at higher loads so as to keep overall weighted NOx emissions the same. The overall SFOC decrease available from the use of the special turbocharging optimization methods is about 3 percent at low to medium loads. Figure 43 shows the impacts on SFOC of the available options. This graph is based on standard optimization at high power as the basis.

The options for turbocharger optimization at partial and low loads are as follows:

Exhaust Gas Bypass (EGB) – For the ME/ME-C series of MAN, up to 6 percent of exhaust gas is bypassed at full load with bypass partially closed between 80 and 90 percent load and fully closed below 80 percent load. A similar pattern is used for engines with a camshaft (MC type). Bypassing the

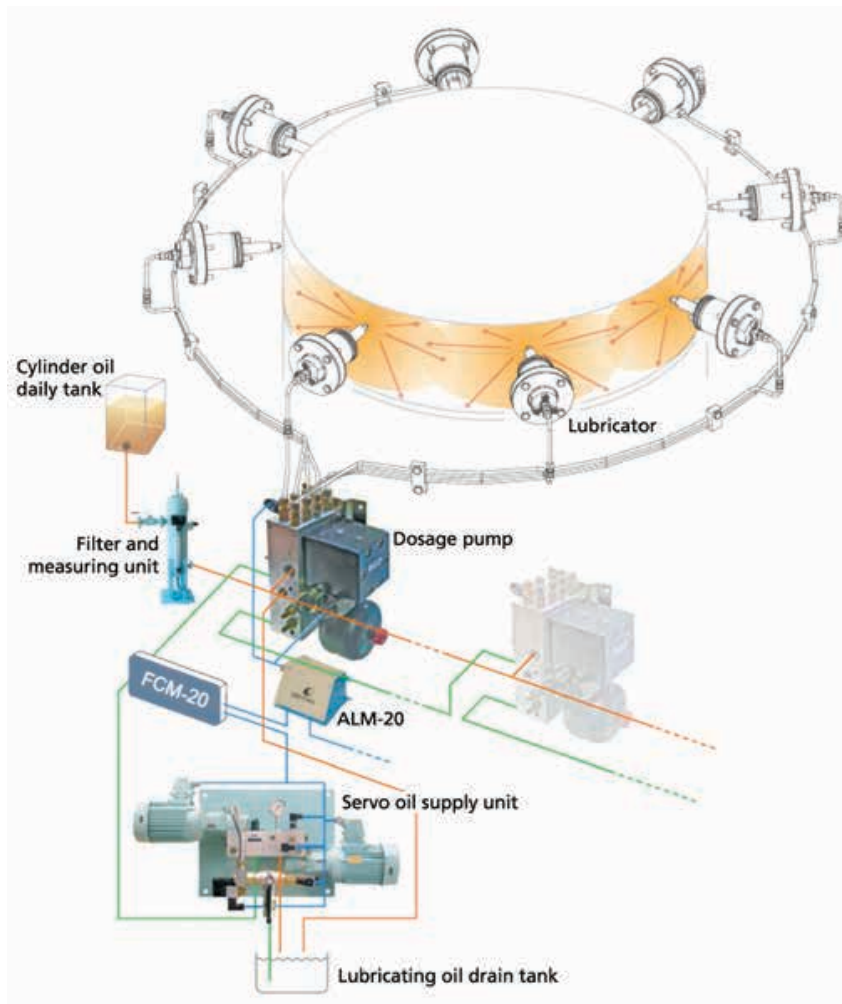

Figure 42. Typical Automated Cylinder Oil Lubrication System (Courtesy of Wärtsilä)

Variable Turbocharger Area (VTA for MAN) and Variable Turbine Geometry (VTG for Wärtsilä) – This method is available for large-bore modern two-stroke and four-stroke diesel engines, as well as for gas engines. The area of the nozzle ring of the turbochargers is varied depending on the load. It requires special turbocharger parts be installed. The nozzle ring area is maximized when at full load and is decreased as engine load is reduced to a minimum at a designated engine load depending on the optimization point. The SFOC curves are similar to those for EGB, with lower SFOC at part or low loads and higher SFOC at full load. This option is available for both ME and MC type engines from MAN and for RTA and RT-Flex engines from Wärtsilä.

exhaust gas allows turbochargers to be tuned to suit part load operation, which would make them incorrectly tuned for full load operation, and is why part of the gas needs to be bypassed. The gain in efficiency at partial loads is offset by a loss in efficiency at full load. Figure 43 shows SFOC for a MAN ME type engine with standard turbochargers and with EGB.

There is a penalty at full load for the part load and low load optimization, but if the ship operates a majority of its time at low or part load then there will be an overall fuel savings. The SFOC reduction potential is better where EGB is combined with variable exhaust valve timing, e.g. common rail engines. EGB is also possible with conventional mechanical control engines (MAN MC type). An added benefit of bypassing some of the exhaust is that this increases the exhaust gas temperature to the exhaust gas boiler, which increases steam output.

Turbocharger Cut-Out (for engines with multiple T/C) – A similar effect can be achieved by cutting out one turbocharger in multiple turbocharger installations. This applies when there are two or more turbochargers.

Engine Control Tuning (ECT) – This is another method available with electronically controlled low-speed diesel engines only. It varies the engine tuning (exhaust valve timing and injection profiling) through P_{max} adjustment to suit low or part load operation at the expense of higher SFOC at full load operation. It must be noted that in case of a mode shift (e.g. low-load to mid-load mode) this must be reported and approved by the flag State Administration.

Engine De-rating and Lower RPM

An engine's SFOC is affected by various factors that can improve its efficiency and that of the

propulsion system. The thermodynamic efficiency of the engine is affected by the ratio of maximum firing pressure to mean effective pressure, with a higher ratio resulting in lower SFOC. Selecting an engine with a higher maximum MCR than is required for the vessel and de-rating it to a lower MCR power that meets the design performance of a ship will result in the de-rated MCR power being developed at a lower mean effective pressure. That allows optimization of the combustion process rather than maximization of the power output thereby improving fuel efficiency. De-rating an existing engine would result in slowing down the maximum speed of the ship.

Costs for a de-rated engine installation are indeterminate as they depend on the effect of a larger engine, on the engine room arrangement and the ship design. In addition, the cost may depend on the shipyard market situation at the time of bidding. Shipyards may offer lower fuel consumption design at no extra cost to obtain orders when fuel prices are high. In the table at the start of the section it is noted that the order of magnitude cost impact is several hundred thousand dollars. EEDI impact of a de-rated engine should be favorable since the fuel consumption goes down for the same power and speed used for the vessel inputs into the EEDI equation. Note that uprating a de-rated engine (back to its design maximum MCR to increase speed) may only be possible if the related engine auxiliary systems (including shafting) are originally designed and installed to match the larger rating. The EEDI would also have to be within baseline limits with the larger rating.

Other ways to increase engine efficiency are by providing a larger stroke/bore ratio and lower RPM, which allows for the use of a larger diameter and more efficient propeller. Electronically controlled engines (ME type or flex type) have greater capability to control the engine parameters, and thus are better able to achieve low SFOC conditions, while still remaining compliant with NOx requirements. Some of the key ways to improve the efficiency of a low-speed diesel propulsion system and the reductions in SFOC that can be achieved from each method are shown in

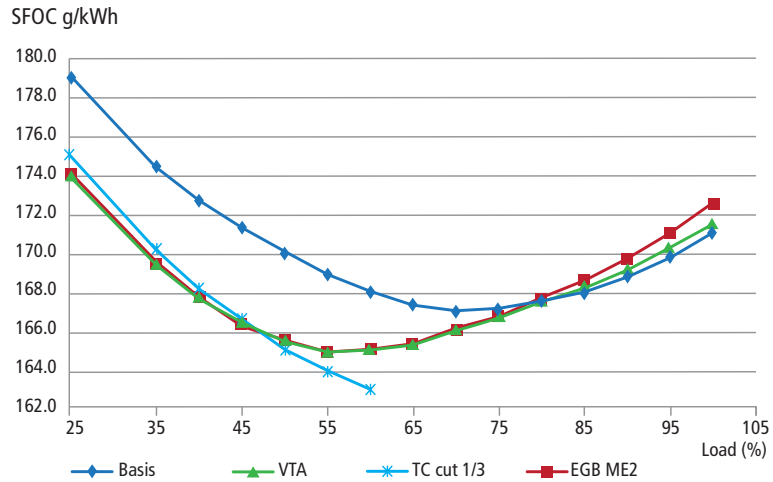

Figure 43. Effect on SFOC of Turbocharger Optimization for Typical ME Type Engine (Courtesy of MAN)

Figure 44. In this figure, SMCR means the service maximum continuous rating which is the MCR rating of the engine after any de-rating.

The alternatives presented are as follows:

- An engine installed at the manufacturer's highest MCR without de-rating. In this case MCR = SMCR = 11,900 kW at 105 RPM. This is the base case.
- The same model engine at the same speed but with one additional cylinder allowing the MCR to be de-rated from MCR = 14,280 kW at 105 RPM to SMCR = 11,900 kW at 105 RPM. This is a reduction of 2.9 percent in SFOC.
- The same engine model as the base case but with one additional cylinder and a reduction in speed to improve propeller performance de-rated from MCR = 14,280 kW at 105 RPM to SMCR = 11,680 kW at 98.7 RPM. This is a reduction of 2.3 percent in SFOC and 1.8 percent in power required for a total fuel savings of 4.1 percent.
- The same as above, but with an electronically controlled engine (ME in this case). This is a reduction of 4.3 percent in SFOC and 1.8 percent in power required for a total fuel savings of 6.1 percent.

Effect on SFOC of Low NOx Emissions Requirements

For low-speed diesel and medium-speed diesel engines, complying with MARPOL Annex VI Tier II and III requirements will increase the engine's SFOC. The change from Tier I to Tier II NOx requirements created a small increase in SFOC, while the change to the very low NOx

Reduced Fuel Consumption by De-rating IMO Tier II Compliance

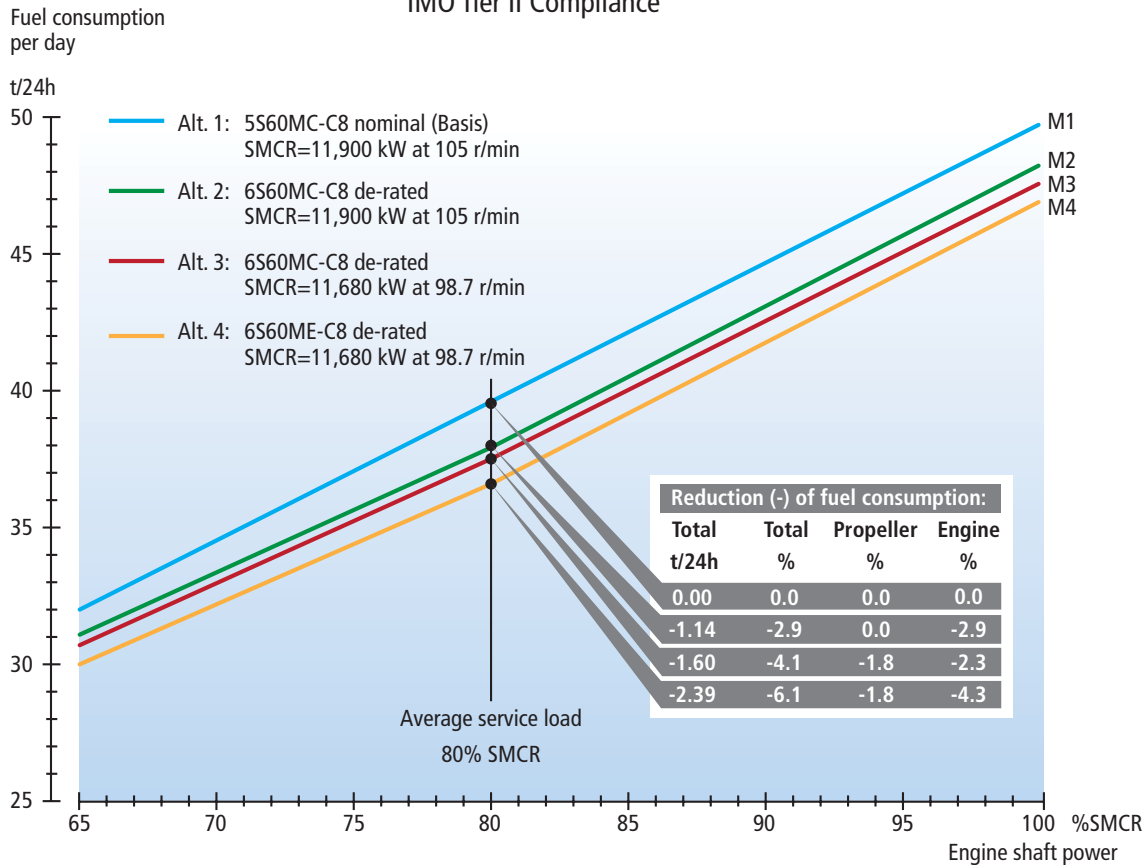

Figure 44. Sample Effects of De-rating and Larger Propeller on Fuel Consumption (Courtesy of MAN)

requirements of Tier III will have a greater effect on SFOC. Tier III requirements will be in effect in ECA zones starting in January 2016, but Tier II requirements will remain in effect outside of ECA zones. It appears that it is not practical to meet the low Tier III NO_x requirements solely by making adjustments only to the engine; rather it will require some type of treatment system to be added. The most likely treatment systems are exhaust gas recirculation (EGR), which recirculates exhaust gas to the engine intake manifold, and selective catalytic reduction (SCR), which removes NO_x from the exhaust gas with a chemical process and does not require modification to the engine. Both methods, EGR and SCR, are under development and no standard solution has been adopted yet. For medium-speed diesel engines SCR appears to be the favored process.

Use of EGR to achieve Tier III compliance will result in about a 1 to 2 g/kWh increase in SFOC over conventional Tier II compliant engines. The alternate method for achieving Tier III NO_x levels

is by use of an SCR. For best efficacy (higher exhaust temperatures promote the SCR reaction) the SCR is installed between the exhaust manifold and the turbocharger on low-speed diesel engines. This affects turbocharger efficiency, which can reduce engine efficiency and increase SFOC. Medium-speed engines have the SCR installed after the turbochargers. These systems are still under development and testing, and the amount of the impact on SFOC, which is expected to be relatively small, is still not confirmed.

It may be possible to restore some of the fuel efficiency lost in tuning engines to meet the Tier II NO_x levels by the engine maker qualifying the engine to the IMO requirements with an SCR. If this were done to meet the Tier II requirements, the SCR would be required whenever the engine was in operation both inside and outside an ECA. By tuning the engine to meet Tier II NO_x without the SCR, the SCR is not required to operate when outside of an ECA, and will not require the addition of urea or similar ammonia source to be added to the exhaust.

Main Engine Efficiency Measurement Instrumentation

Savings	No direct savings, but adds ability to monitor consumption.
Applicability	Low-speed and medium-speed diesel engines.
Ship Type	New and existing engines
New/Existing	New engines only
Cost	\$20,000 to \$75,000 for meters, controls and displays.

In order to evaluate the energy efficiency of a ship's propulsion system it is necessary to accurately measure and track fuel consumption and power. That cannot be done properly without effective instrumentation. The standard noon-to-noon measurements of fuel consumption based on soundings and measurements of engine power based on simple parameters like RPM, fuel rack position and turbocharger RPM are not accurate enough and can only measure the effects of large changes in SFOC from changes in operation or major deterioration of engine performance. It is recommended that instrumentation to directly measure shaft power and fuel consumption be installed in order to accurately monitor propulsion plant efficiency. This instrumentation is described as follows.

Shaft Power Meter

Fuel consumption should be converted to specific fuel oil consumption (SFOC) (g/kWh) in order to monitor fuel efficiency of the machinery plant since fuel consumption varies directly with power. The most accurate way to measure engine output on a real-time basis is to install a shaft power meter directly on the propulsion shaft(s). There are two common types:

Strain Gauge – This is the most common type of power meter. It uses strain gauges mounted on the shaft to measure its rotational deflection. Using the shaft's rotational deflection the torque can be calculated and shaft RPM is also measured. By using both torque and RPM, shaft power can be calculated since power equals torque x RPM x constant. Thrust measurements are also possible with some of the shaft power meters. Modern types usually have wireless transmission of data from the gauges to a stationary data collector mounted around the shaft, and this same system provides power to the strain gauges using induction.

Optical – This type does not depend on the mounting of strain gauges, but measures the deflection between two light sensors mounted a distance apart on the shaft. LEDs are used to produce the light signal. Power is supplied to the shaft mounted equipment using induction. Data from the rotor is transmitted to the stator and data processing unit. Periodic recalibration is not needed.

Fuel Flow Meter

Another key part of knowing the efficiency of a machinery plant is to accurately measure the fuel used by each of the primary consumers. Real-time fuel consumption measurements are best done by installing fuel flow meters in the fuel supply lines to the engines and boilers (if desired). As a minimum, at least one fuel flow meter should be installed to measure fuel consumption of the main engine. It is best to also measure the fuel consumption of auxiliary engines to monitor total fuel consumption. If the fuel flow meter is installed in the supply line from the service tank to the main fuel module then one meter is sufficient to measure overall consumption.

If measurements for separate engines in a multi-engine power plant are required (or to separate diesel generator consumption from main engine consumption) then separate supply and return meters for each group of engines should be installed. There are a couple of common types of fuel flow meters in use on ships:

Positive Displacement – This is the most common and lowest cost type. The volume of flow is measured directly, but output data has to be adjusted for temperature and density to obtain mass flow (such as kg/hour). Several methods are available to measure volumetric flow; usually some type of vane rotor or nutating disk is used. Accuracy of volume flow is about 0.5 percent, but accuracy of fuel flow by mass depends on the accuracy of the input fuel density data. The density data depends on having an accurate fuel oil analysis with specific gravity accurately determined and accurate data on the fuel temperature as it flows through the meter.

The measured specific gravity is then corrected for the temperature to get the density that is used to determine the mass flow rate. The uncertainties in the specific gravity and temperature measurements can introduce significant errors to the mass flow calculation.

Coriolis – This type measures mass flow directly and has no moving parts in the flow stream so this type will not be affected or clogged by the fluid being measured. Coriolis-type flow meters calculate the mass flow of the fluid based on the difference in vibration between two tubes, which is a function of the mass of fluid in the tubes. Accuracy of fuel flow by mass is about 0.5 percent.

Main Engine Performance Measurement and Control

Savings	1 to 2 percent reduction in SFOC by tuning the engine.
Applicability	Low-speed and medium-speed diesel engines.
Ship Type	All
New/Existing	New and existing engines
Cost	Variable, \$5,000 to \$50,000 depending on whether portable equipment (lower cost) or fixed equipment (higher cost).

Besides measuring the fuel efficiency of the propulsion plant, it is important to directly measure the performance of the main engine and the combustion processes taking place in the cylinders. This applies mostly to low-speed diesel engines, but similar measurements can also be made for medium-speed diesel engines.

Diesel Analyzers

Computer-based systems for monitoring cylinder and fuel injection system performance are widely available and have been in use for many years. They are useful for checking engine balance (equal power from each cylinder), ignition timing, checking for cylinder overload, trending, cylinder wear, and for maintenance planning. Two types are in use: the more commonly used portable type in which a pressure transducer is shifted from cylinder to cylinder; and the fixed type, usually installed by the engine maker, with fixed pressure transducers on each cylinder and real-time, full-time cylinder monitoring on a computer. Each type is discussed as follows.

Portable – Measurements are made using a portable data logger that has a pressure sensor on a portable cord that is manually connected to the cylinder head indicator cock of each cylinder, one by one, and a crank angle sensor mounted on the engine. The measured information is read by the portable data logger, which may have its own internal processing software with a data display monitor or it may just collect the data, which is

then transferred to a computer for analysis and display. Optionally, some analyzers will analyze fuel injection pressure and scavenge air pressure if sensors are provided. Cylinder and fuel injection pressures versus crank angle or cylinder volume can be calculated and graphically presented. Bar graphs or other graphical means are available to show and compare between cylinders the mean indicated pressure, maximum combustion pressure, compression pressure, expansion pressure and ignition timing. These are all effective tools for tuning the engine to obtain the most efficient performance and lowest fuel consumption.

Portable diesel analyzers can be purchased from several makers. Most come in a case with the required sensors and data collection hardware. A CD is provided for installing the analysis software on a computer. A method of data transfer from the data collection unit to the computer is provided, usually a USB-type connection on modern units.

Fixed – The same equipment that is provided on the portable analyzer – cylinder pressure transducers, crank angle sensor, scavenge air pressure transducer and other sensors, as needed, can be installed permanently on the engine and wired to a data logger and processor. Usually the cylinder pressure transducer is a special fitting that replaces the indicator cock and serves both as pressure transducer and as the venting cock for the cylinder. For MAN engines the fixed type is called PMI On-Line; and for Wärtsilä it is called the Intelligent Combustion Monitoring (ICM) system.

The potential savings from using diesel analyzers, either portable or fixed, is not a direct reduction in fuel consumption, but use of one of these analyzers allows the operator to see when the engine is operating in a non-optimum manner, which leads to higher fuel consumption. By using the analyzer, pressures in the cylinders can be balanced and worn parts that reduce the combustion effectiveness (e.g. worn piston rings, injectors) identified. Restoring the engine to optimum performance can reduce fuel consumption by about 1 percent, assuming the engine is not far out of tune, and by more if it is.

Low-speed Diesel Engine Tuning Using Online Analyzers

Low-speed diesel engines fitted with fixed analyzers and electronic control over the fuel

injection process can now have real-time, full-time monitoring and control of the combustion process in each cylinder. Such a direct performance measurement and control system can keep the engine operating at optimum performance all the time. By balancing all the pressures in the cylinders, the average maximum cylinder pressure (P_{max}) for the engine can be increased. For every 1 bar increase in P_{max} there is about a 0.2 to 0.25 g/kWh decrease in SFOC. By using the injection process controls to balance the combustion in each cylinder it is possible to achieve an overall 10 to 15 bar increase in average P_{max} for an engine. This can reduce SFOC by up to 1.5 percent. How balancing pressures in the cylinders increases average P_{max} is shown in Figure 45.

The system works by controlling the start of fuel injection and exhaust valve timing to optimize the combustion process in each cylinder. Doing this automatically all the time is more effective than manually checking periodically each cylinder using a portable analyzer. Manual checking also does not check all cylinders simultaneously so engine loading may not be constant over the period of measurement. In addition, a set of manual measurements may be used to optimize for a specific engine load, but could be less effective for other loads.

A fixed automatic system allows adjustments in real time at each engine load and for all cylinders simultaneously. The tuning control of the engine can also be used to adjust engine operation at low load to both lower SFOC and stay within NOx requirements as discussed in earlier sections.

Automated combustion control systems have different names by the major engine makers:

MAN – Computer Controlled Surveillance (CoCoS)

Wärtsilä – Intelligent Combustion Control (ICC) and Delta Tuning (for low load operation)

Waste Heat Recovery

A significant amount of heat is generated by the machinery plant on a ship. While modern diesel engines are very efficient, with greater than 50 percent of the energy generated by the combustion of fuel oil being converted to mechanical energy, they still generate a large amount of waste heat when running at full load. The heat is removed from the engine in many forms. About 5 percent of the engine's total energy production goes to the engine cooling water system and about 25 percent is contained in the exhaust gas. In both these forms the heat is useful as a heat source for other systems.

Reduction in Fuel Oil Consumption / CO₂ Emission

1 bar increase in average P_{max} => 0.20 - 0.25 g/kWh decrease in fuel oil consumption

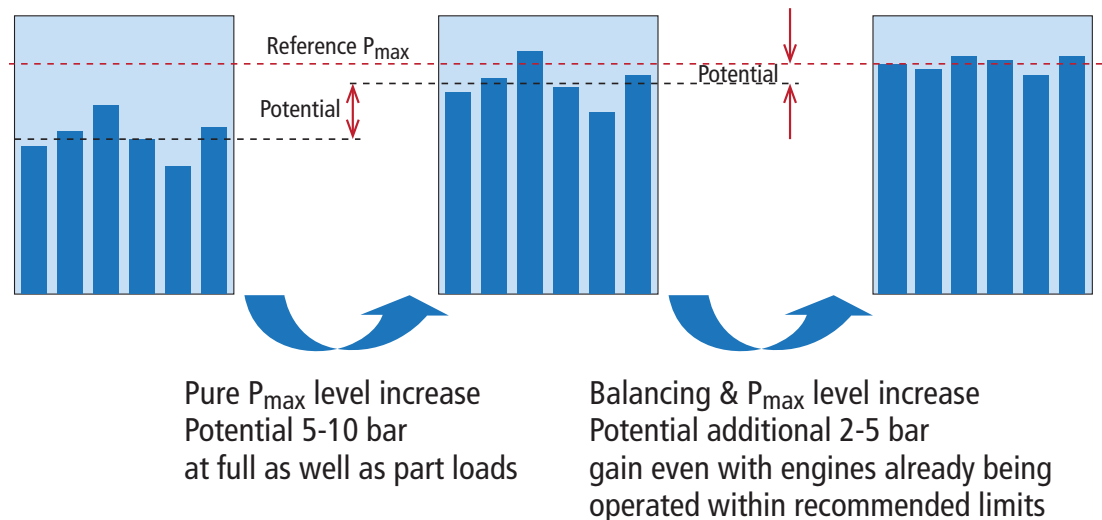

Figure 45. Increase in P_{max} with Fixed Analyzer and Electronic Controls (Courtesy of Wärtsilä)

For many years it has been common to use the heat from the main engine high temperature cooling system to generate fresh water and the heat in the exhaust gas to generate steam for heating. As the size of the ship and its engines increase, the amount of exhaust heat available increases much more rapidly than the demand for steam for heating. This is because the primary uses for the steam are heating oil tanks and accommodation spaces.

For most commercial ships the total size of the accommodations is about the same since the crew size is roughly the same. The amount of steam for oil heating grows slightly with the engine size, but the tank heating requirements do not grow very much, since only tanks in use are heated, and the size of those individual tanks doesn't vary significantly. This results in a surplus of heat available on ships with large engines after the more traditional services have been fulfilled.

Improvements in turbocharger technology have also increased the heat available in the exhaust stream since they require less energy for the same boost than the older units. Technology is now available that can take the excess exhaust heat and use it to power an exhaust gas turbine and/or to generate additional steam to power a steam turbine. In the design of these systems it is important to properly account for the time spent at low or medium engine load as this may significantly

reduce the amount of waste heat available. A sample system is discussed below, but there are other systems available, many of which take a similar overall approach.

Exhaust Gas Heat Recovery – Steam

It is possible to increase the energy output from a large low-speed diesel engine with high-efficiency turbochargers by up to about 11 percent by adding exhaust gas turbines and steam turbines. A system to accomplish this typically consists of an exhaust gas boiler, a steam turbine (ST), an exhaust gas turbine (EGT) and a common electrical generator for the two turbines. Some systems will not have an EGT and only an ST. Less power will be available from such a simple system, but it will require less modification of the main engine. Exhaust gas for the turbine bypasses the turbocharger via a bypass valve. The exhaust bypass to the EGT is closed at engine loads below 50 percent. Figure 46 shows the basic layout of a low-speed diesel engine with an EGT and ST with generator.

If there is excess electric power generation it is possible to dump steam to the condenser or close the exhaust gas bypass. Typically, the added electric generator can be operated in parallel with the ship service diesel generators (SSDGs) and, in some cases, all the at-sea electric power can be generated by the waste heat recovery generator, allowing the SSDG to be shut down, saving fuel

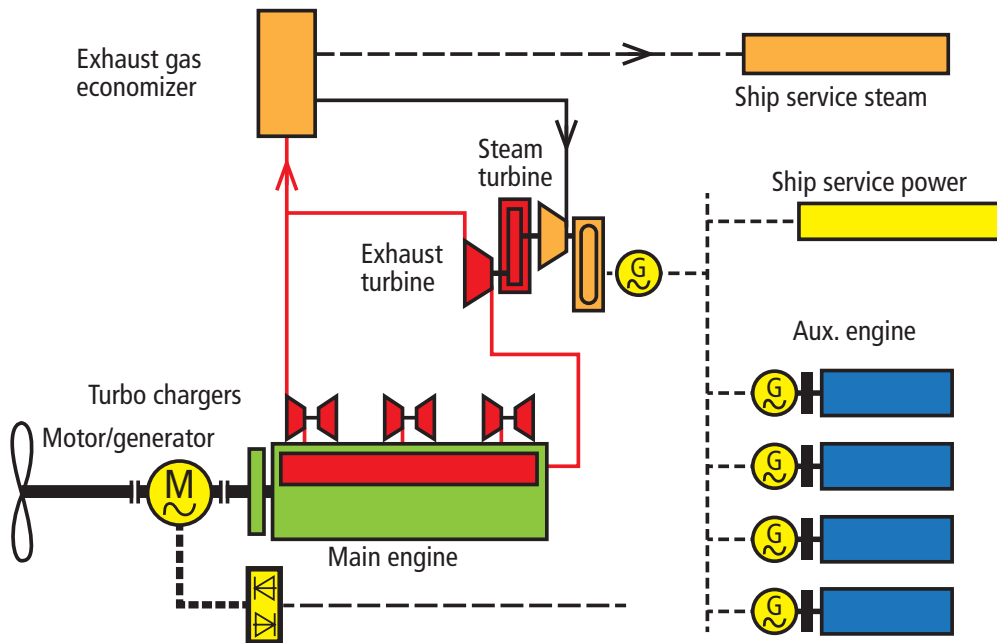

Figure 46. Layout of Low-speed Diesel Engine with Exhaust Turbine and Steam Turbine with Generator (Courtesy of Wärtsilä)

and maintenance. About 3.6 percent of MCR power is available from the exhaust turbine at 90 percent MCR, and no additional power at less than 50 percent MCR (bypass valve closed). Depending on whether P_{max} is adjusted to suit the addition of an exhaust gas turbine, the SFOC increase caused by having an exhaust gas bypass can range from 0 percent (P_{max} increased) to +1.8 percent (standard P_{max}). Exhaust temperatures can increase by up to 50°C.

To provide steam to the ST the traditional exhaust gas boiler is replaced with an expanded unit that includes a superheater section. Figure 47 shows a simple single pressure steam system with saturated steam at 7 bar absolute (6 bar g) with steam temperature at 165°C. Superheated steam at 270°C is generated in the lower part of the boiler. Figure 48 shows a more complex system that has two superheat steam pressures and two steam inlets to the turbine, high pressure (10 bar) and low pressure (4 bar). Adopting the more complex two pressure system gains about 1 percent in power output (percentage of MCR), but it needs to be evaluated if the extra complexity and cost is worth the gain in power. Figure 49 shows the electric power production relative to MCR that is

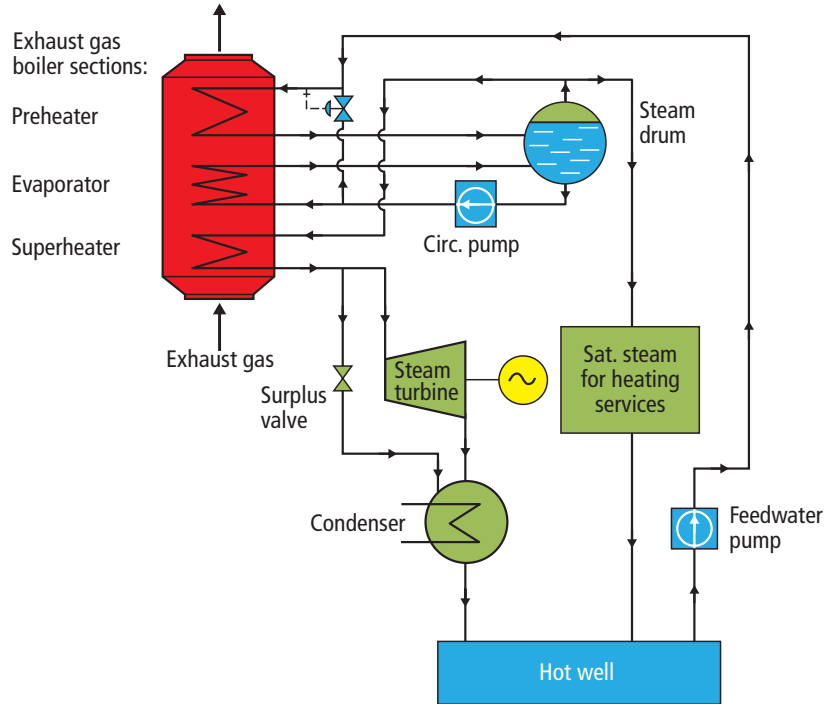

Figure 47. Simple Single Pressure Steam System with Steam Turbine (Courtesy of MAN)

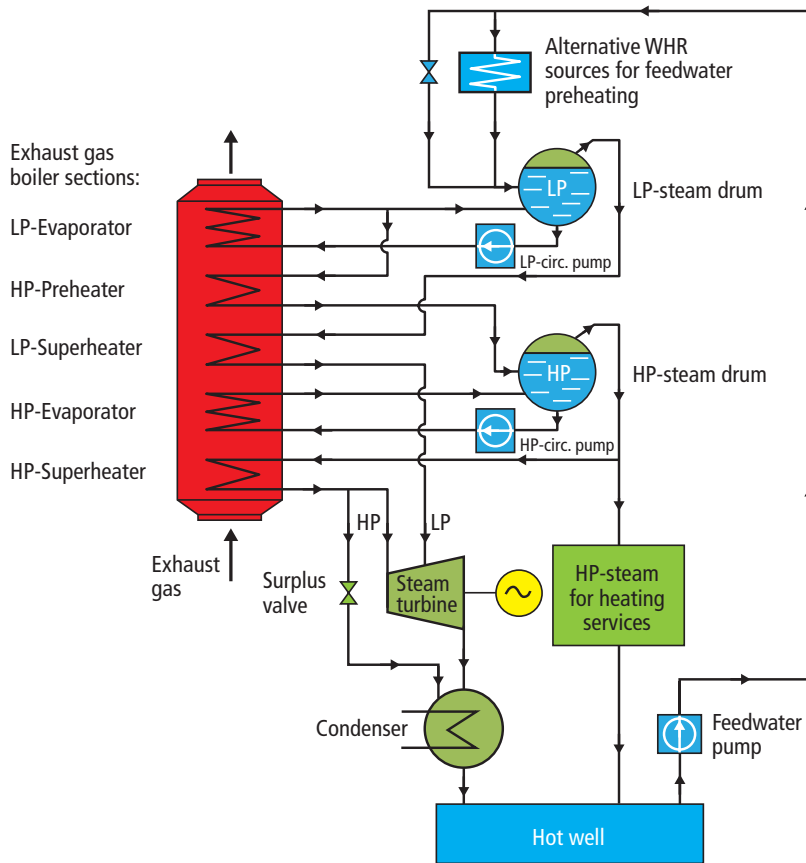

Figure 48. Dual Pressure Steam System with Steam Turbine (Courtesy of MAN)

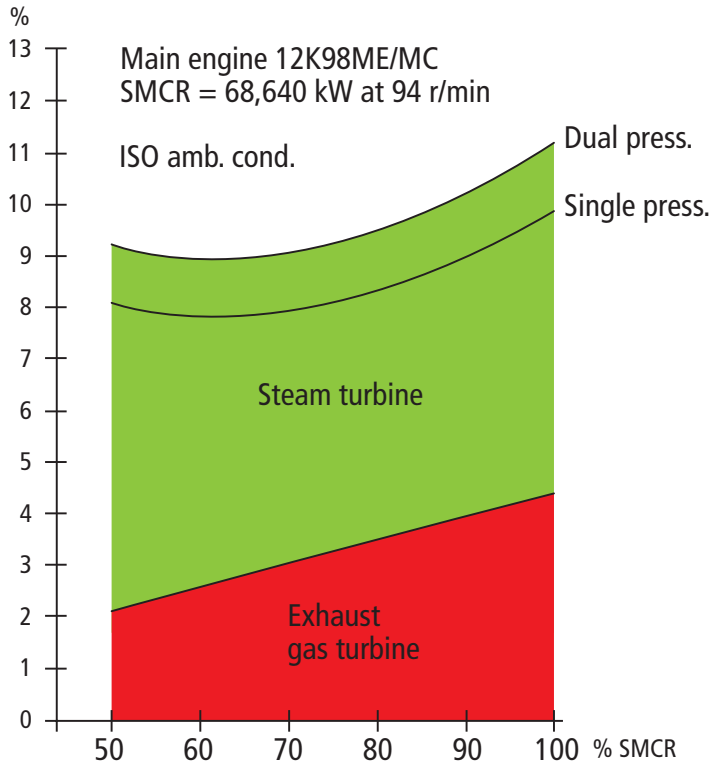

Figure 49. Available Power from Combined Steam Turbine and Exhaust Gas Turbine (Courtesy of MAN)

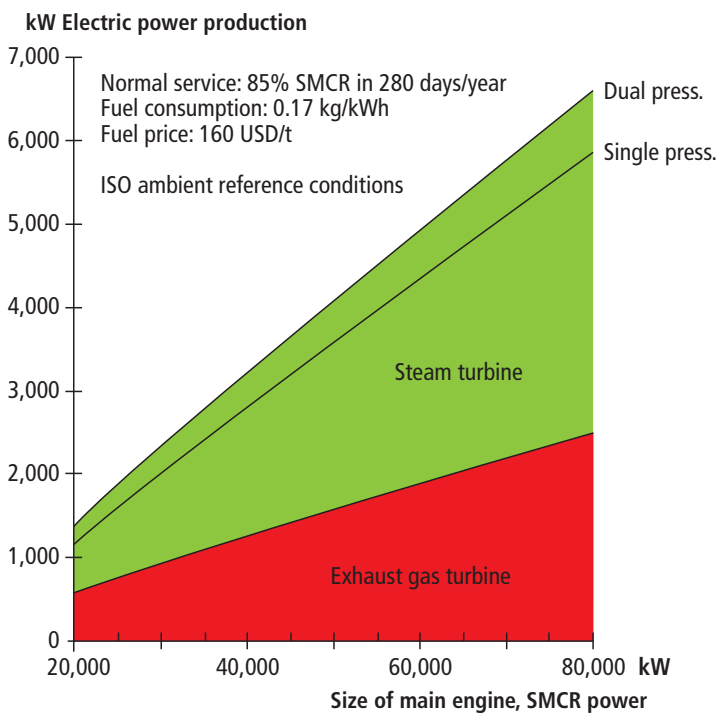

Figure 50. Available Electric Power Generation by Main Engine Power (Courtesy of MAN)

possible with the installation of an exhaust turbine and single or double pressure steam turbine. For larger sized engines up to several MW of power can be produced. This is more power than the typical ship's service electrical load, unless the vessel is a containership with a large number of reefer containers on board. The alternative to using the generated power only for ship's service electric power is to install a power take in (PTI) motor that will allow some of the generated power to be used for propulsion power. In this way all the generated power can be used. The system shown in Figure 50 includes a PTI motor mounted directly on the shaft.

Power generation from waste heat is considered possible for engines of 20 MW and above as shown in Figure 50. The available fuel savings increases significantly with engine size. Payback periods can vary significantly depending on fuel cost, whether all the generated power can be used, the complexity of the installation (is PTI motor included or not) and the days of operation at high power.

Under favorable circumstances the payback period can range from two to four years for an EGT-powered generator and three to six years for a combination EGT and ST-powered generator. High fuel cost will lead to a payback time at the shorter end of the range. Investment cost for an EGT and ST with generator is about \$4 million to \$7 million, depending on engine power (system size), and will be about \$1 million higher if a PTI motor is included. The payback period can also be affected significantly by the number of hours per year that it can be operated. Ships on long voyages at high power will benefit the most. These costs are for new construction. The cost of retrofitting an existing ship is usually very high.

Exhaust Gas Heat Recovery – CO₂

New advances in exhaust gas heat recovery are focused on Rankine Cycles using other thermal medium such as supercritical CO₂. Supercritical CO₂ (sCO₂) operate much the same as traditional waste heat recovery but offer a much smaller footprint than traditional systems. These systems shown in Figure 51 are still in their initial phases of testing but may offer significant benefits for systems where sufficient thermal energy remains in the exhaust gas. Such systems are anticipated to have lower costs for energy generation and low maintenance.

Auxiliary Equipment

Besides improvements in the energy efficiency of the diesel engines the energy efficiency of electric power generation and auxiliary equipment on board ships can be improved. Some of the more widely used methods are discussed in this section.

Shaft Generator

There are several different types of shaft generators in common use on ships. The simplest type is a shaft generator connected to the main engine by a gearbox with a fixed gear ratio. To obtain constant frequency electric power the main engine must operate at constant RPM, which requires the use of a controllable pitch propeller (CPP). This is well suited for medium-speed diesel engines, which are normally fitted with a CPP. A shaft generator powered by the main engine operating at constant RPM cannot operate in parallel with ship service

diesel generators (SSDG). The reason for this is that main engine RPM will vary more than the diesel generator's RPM, particularly when the ship is pitching in waves, plus the larger size of the main engine means it accelerates slower than smaller diesel generators, making it hard to hold constant frequency and load sharing between the two generators.

It should also be noted that at less than full power a CPP operating at constant RPM has reduced propulsion efficiency because this is a less efficient operating point on the right side of the optimum propeller curve (higher RPM and less pitch than optimum). Frequent operation at part load conditions with this type of shaft generator can actually raise annual fuel consumption, even though the main engine has lower SFOC than a SSDG. The increase in main engine SFOC caused by suboptimum propeller setting offsets the savings in SFOC for generating power. In addition, it should be noted that the transmission efficiency for the gear driving a shaft generator from a low-speed diesel is typically about 92 percent. This means that 8 percent of the power developed by the propulsion engine is lost in the transmission. Whether there is a fuel savings or fuel increase very much depends on the specific circumstances of the vessel and its service.

Alternative shaft generators are available that have either variable ratio gears or frequency control. Both of these types can work with a fixed pitch propeller over a range of RPM (usually 75 to 100 percent RPM), alleviating some of the issues with

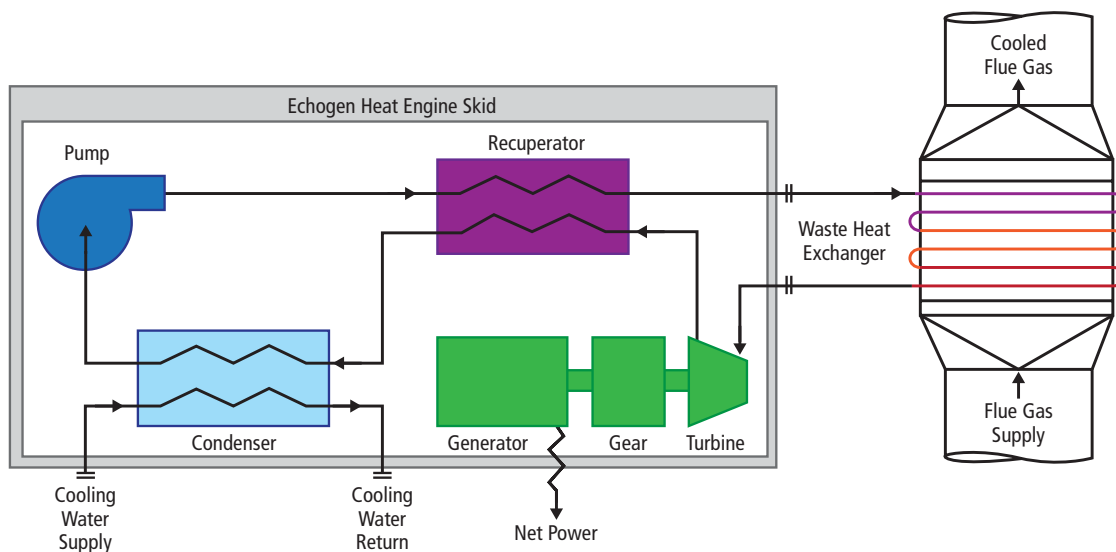

Figure 51. CO₂ Heat Recovery Cycle (courtesy of Echogen Power Systems)

the constant gear ratio shaft generator. However, these shaft generators are more expensive and less efficient so the savings in fuel compared to using a SSDG is unclear for these types as well. Typical efficiency for a variable speed gear drive is 88 to 91 percent; and for the variable frequency shaft generator the efficiency can be as low as 81 percent and up to about 88 percent. It is most likely savings will be found from installing a shaft generator if it is possible to substitute one shaft generator for one SSDG. If this can be done there will be savings from the reduced installation cost of the shaft generator compared to the SSDG and, similarly, from the reduced maintenance costs of the shaft generator. However, depending on the specifics of a project, the payback can be many years, if at all.

Number/Size of Ships Service Generators

The electrical loads for various modes of operation of the vessel should be estimated, and an electrical generating plant installed that provides the required electrical power with sufficient standby power to replace the largest generator in operation. For best operation, from the standpoint of both fuel efficiency and maintenance, it is best to have generators that are driven by diesel engines operating between about 60 and 90 percent of their rating for the ship's typical operating conditions.

For new ships, the number of generators required for each load case, and their respective loading as a percentage of their rating should be carefully evaluated to avoid extremes of loading, either too low or too high. For ships that are already built, the number of units being operated and their loading should be monitored and units started or stopped to keep the engine loads between 60 to 90 percent unless other conditions warrant operation outside this load band, such as during maneuvering.

Many new ships have power management systems to determine automatically how many of the installed generators should be in operation simultaneously. The automation system in this case may also stop certain pre-determined equipment in order to keep the electrical load manageable by the number of generators in operation.

Other Auxiliaries

The number of pumps, compressors and other items of equipment installed are determined

by classification society, IMO and flag State requirements, based on the need for redundancy in case of failure of a running unit, and to provide operational flexibility. Unit size/capacity and the number of units installed are selected to meet the most severe design conditions. For example, often three sea water cooling pumps are provided, each rated for 50 percent of the maximum sea water demand when the sea water is at the maximum design temperature.

Often in service, the sea water temperature is significantly below the maximum design temperature, some cooling loads are not in operation, heat exchangers may not be fouled to the extent assumed in their design specifications, and the main engine is operating at less than its maximum continuous rating. The result is that the system's cooling requirements may be served by only one pump, thus saving the energy required for running a second pump.

Many ships have two central coolers designed for 50 or 60 percent of the maximum cooling load, allowing one unit to be secured in less than maximum conditions. This allows the cooler to operate near design conditions of flow even though only one pump may be in service. Operators should be aware of these savings and should endeavor to operate only the number of units required to meet the actual demand without sacrificing safety. This applies to both new and existing ships. The installation of dedicated cooling pumps of lower power for use only in ports should be also considered.

Heating, Ventilation and Air Conditioning (HVAC)

HVAC systems on commercial cargo ships are not large consumers of power, but there are several ways to improve efficiency and reduce the required power. In the case of air conditioning and heating systems, one way to reduce the power load is to provide for energy transfer between the incoming air and the exhausting air. This allows the cool air being exhausted from the air conditioned accommodation to pre-cool the incoming air, and similarly in winter months to heat the incoming air with the warm air being exhausted. This energy transfer can be carried out by installing a simple circulating system comprising a pump and heating/cooling coils in the main supply and exhaust ducts. Other systems have been used for large cruise ships that require a

rotating bed that passes through one duct and then the other, but these require the ducts to be adjacent to each other, require more space and can be expensive.

Automated AC control systems can also be supplied that monitor actual demand on the system and control the system to provide a variable capacity sufficient to meet the need rather than operating at full capacity all of the time.

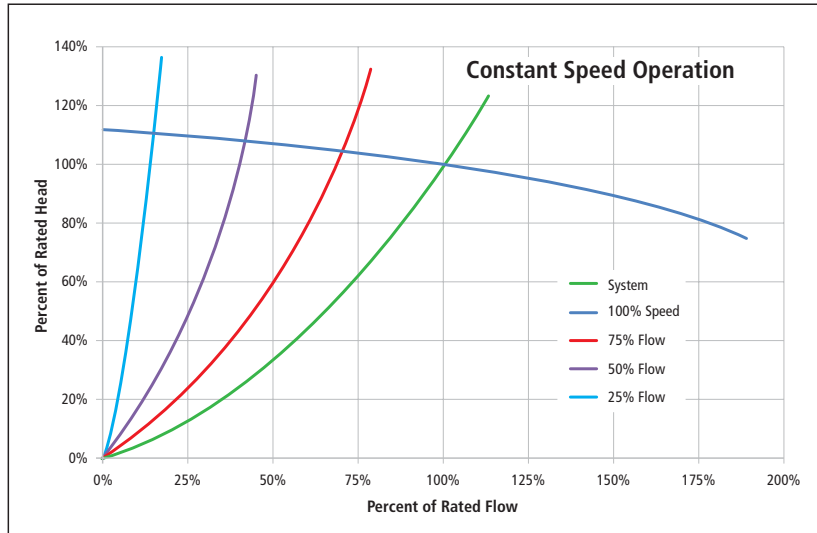

Figure 52. Varying the System Flow Rate with a Constant Speed Pump

Machinery space supply fans often have rather large motors, many of which are two-speed. When heat generation due to engine loads and combustion air requirements are reduced, fans should be secured or slowed down to match the actual ventilation requirements.

Variable Speed Motors: Pumps and Fans

Variable speed motors can improve the operating efficiency of pumps and fans that operate at variable loads. As an example, consider a large pump, such as a main sea water cooling pump provided with a constant speed motor. The only way to vary the capacity of this

pump is by throttling the pump's discharge valve. Figure 52 illustrates this principle. As the flow is reduced from 100 percent down to 25 percent, the system resistance curve must be increased by throttling the pump discharge and moving the system resistance curve to the left, making it cross the pump curve at the desired flow rate.

With a variable speed pump, the required flow rate can be achieved at a reduced head by slowing the pump down. This is shown in Figure 53. In this case, the system resistance curve does not have to be increased to cross the pump curve at the required flow; rather, the pump is slowed down so that the pump curve crosses the system curve at the desired flow rate.

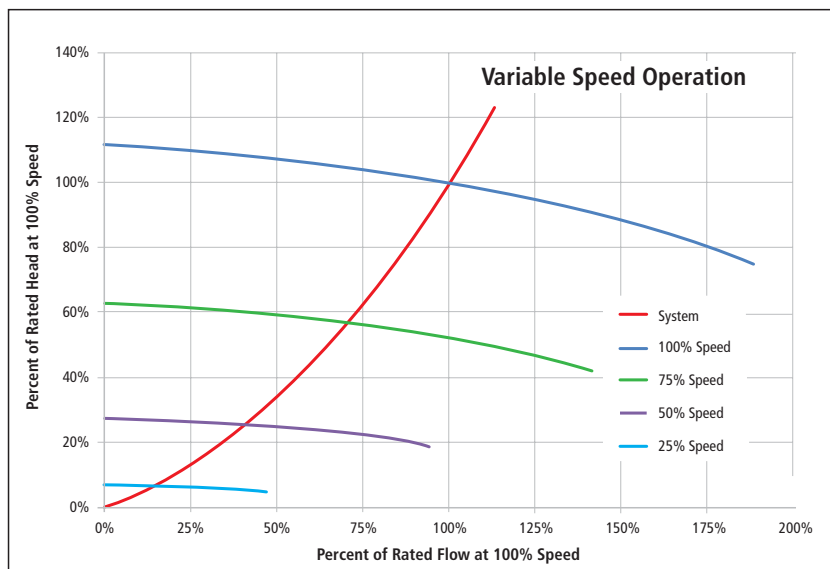

Figure 53. Varying the System Flow Rate by Varying Speed

For the constant speed pump, the power required at each of the lower flow rates is somewhat less than at the rated power, since the required power normally increases from zero discharge to full rating. For the variable speed pump, the power required is substantially reduced at less than full flow rates because while the flow rate is the same as

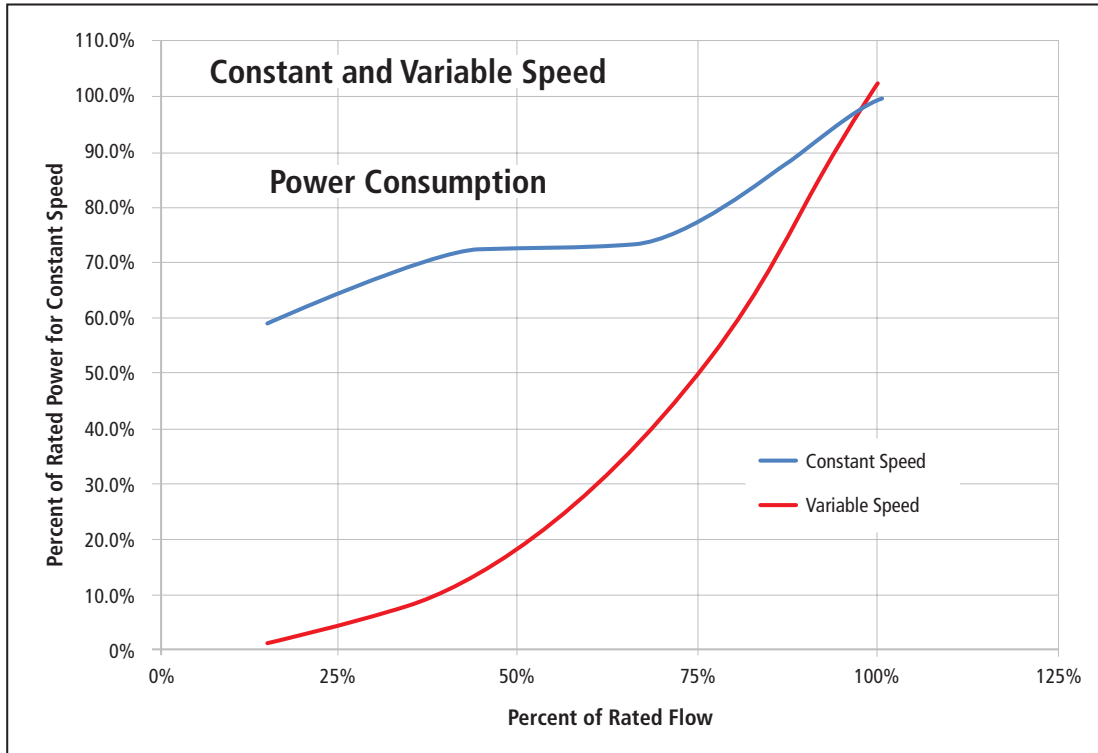

Figure 54. Power Required for Constant Speed and Variable Speed Pumps

for the constant speed pump the head produced is much less, saving energy. The power for each case is shown in Figure 54.

It should be noted that at 100 percent rated flow, the power required for the variable speed pump is about 3 to 4 percent higher than for the constant speed pump. This is due to the electrical losses in the variable speed electronic controls. The higher power for the variable speed unit is only between about 97 and 100 percent of the required flow. As the flow requirement is reduced below about 97 percent, the variable speed pump rapidly produces increasing savings.

This technology allows a system like the main sea water cooling system to be controlled so that only as much water as is actually required is pumped, and only to the pressure required for the system without throttling.

A similar savings is obtainable for large fans and other equipment that operate, or could operate, at variable capacity. Equipment that usually operates only at full rating, such as ballast pumps, fire pumps and starting air compressors, would not benefit by having variable speed drives, but variable speed may be attractive for screw-type ships' service air compressors.

Section 5

Fuel Efficiency of Ships in Service

Introduction

An operator's most direct and useful tools for improving a vessel's performance are the operational decisions made on a daily basis on how to conduct a voyage, perform regular maintenance and monitor fuel consumption efficiencies. Every voyage offers the opportunity to optimize speed, find the safest route through calm seas and make sure the ship is sailing at the best draft and trim and tuned to keep course efficiently. Selected maintenance cycles impact the resistance created by the hull and propeller.

Accurate and regular energy use monitoring across the fleet can highlight inefficiencies and provide a mechanism for continual improvement. Sharing the energy use data across a fleet can even spark competition among crews to better their energy performance.

These efforts speak directly to the goals of the recently mandated IMO Guideline on Ship Energy Efficiency Management Plans, a top-down framework that captures the corporate commitment to energy conservation. In this section we look at the key operational factors that should be considered for energy conservation on ships in service and for overall energy efficiency management. The contents of this section are:

Ship Operation: Voyage Performance Management

- Voyage Speed Optimization
- Weather Routing – Safe and Energy Efficient Route Selection
- Trim/Draft Optimization
- Autopilot Improvements

Hull and Propeller Condition Management

- Hull Roughness and Its Impact on Resistance
- Hull Roughness Management
- Propeller Roughness Management
- Condition-based Hull and Propeller Maintenance

Ship System Management

- Reducing Onboard Power Demand
- Fuel Consumption Measuring and Reporting

Overall Energy Efficiency Management

- Ship Performance Monitoring
- Ship Energy Efficiency Management Plan (SEEMP)

Ship Operation: Voyage Performance Management

There are several operational factors that can be managed on a voyage basis to increase fuel efficiency. These are discussed as follows separately, but it is important to consider them together for maximum gain. This is becoming the norm as more total voyage performance management systems are being offered in the marketplace. Some are described as 'performance-based navigation' systems.

These vessel management systems and/or software products integrate and optimize some or all the energy-saving operational decisions. These include 'just in time' speed, reduction of added resistance due to weather (wind, waves and current) with weather routing, minimizing rudder usage with adaptive autopilot settings, optimizing quantity of ballast carried and trim for lowest hull resistance, and making changes to reduce time in port.

The more capable systems use predictive models with all these factors to plan the most efficient voyage – what route to take, what speeds to use on each leg, what trim to use and how much ballast to carry, and what autopilot strategies to use given the weather.

Voyage Speed Optimization

Savings	10 percent reduction in speed gives approximately 20 percent reduction in propulsion fuel consumption.
Ship Type	All ships, but biggest improvements occur for higher speed ships.
New/Existing	New and existing
Cost	Costs are complex and depend on changes in engine maintenance as well as time value of cargo, reduced demand by shippers for slower ship, and charter party agreements for fuel and speed.

The speed of a vessel has a dramatic impact on the fuel consumption because the speed is related to the propulsive power required by approximately a third or fourth power relationship. Roughly speaking this means if you double the speed you increase the power required by a factor of at least 8. Likewise, sailing at 90 percent of the design speed requires only 75 percent of the power. The corresponding reduction in total fuel consumption is offset a bit by the longer time spent to complete the voyage. So, by slowing down 10 percent the vessel can save about 20 percent in fuel for a given voyage. This significant savings makes it easy to understand why there is substantial interest in slow steaming, especially when fuel prices escalate. It is also a factor in why the EEDI includes speed.

However, depending on market conditions, sailing at lower speeds can come at some commercial loss. Market demands place expectations on the speed of cargo delivery, contracts and charter parties may stipulate speed, machinery and equipment may not perform well at extended low load operation, and more ships may be required to move the cargo, and so on. Finding the proper balance between low fuel consumption at slower speeds and these other costs is what voyage speed optimization is

all about. Because market demands are constantly changing, the optimum speed is not fixed and must be reevaluated on a regular basis in consultation with the various stakeholders.

Ships Designed for Lower Speeds

For any service with estimated cargo quantities per annum and a target fuel cost, the optimum design speed can be determined from an economic analysis such as a required freight rate (RFR) analysis. This analysis includes the number of ships necessary to meet the cargo demands at some speed, capital costs and operating costs. It is a convenient way of judging the economic efficiency of a range of designs. If one is considering acquiring new vessels, performing this RFR analysis considering a range of potential fuel costs is a good way to get the most efficient speed at the outset. This is discussed in Section 1, Hull Form Optimization.

Slow Steaming

For existing ships and ships where the trading market has established a de facto standard or 'expected' design speed, sailing slower than the design speed on those legs of the voyage where the schedule allows is the only way to realize fuel savings. The focus then shifts to finding where in

the schedule one can squeeze out some extra time to slow down and also how to make the machinery plant run at low load. The most successful slow steaming strategies look at all parts of the ship and cargo logistics chain, including port operations and customer demands, in order to identify the slowest possible sea speeds.

For example, ship scheduling and speed control for liner and ferry services must be tightly integrated with overall service planning and cargo management. The penalties for arriving late (and the loss in service reliability or disruption in terminal schedule) may be very costly and historically have led to speed margins that are conservative and fuel inefficient. Nevertheless, even on liner and ferry services there are legs where the schedule is controlled by the shoreside operational window, such as stevedoring work schedule and slow speeds, may be comfortably utilized.

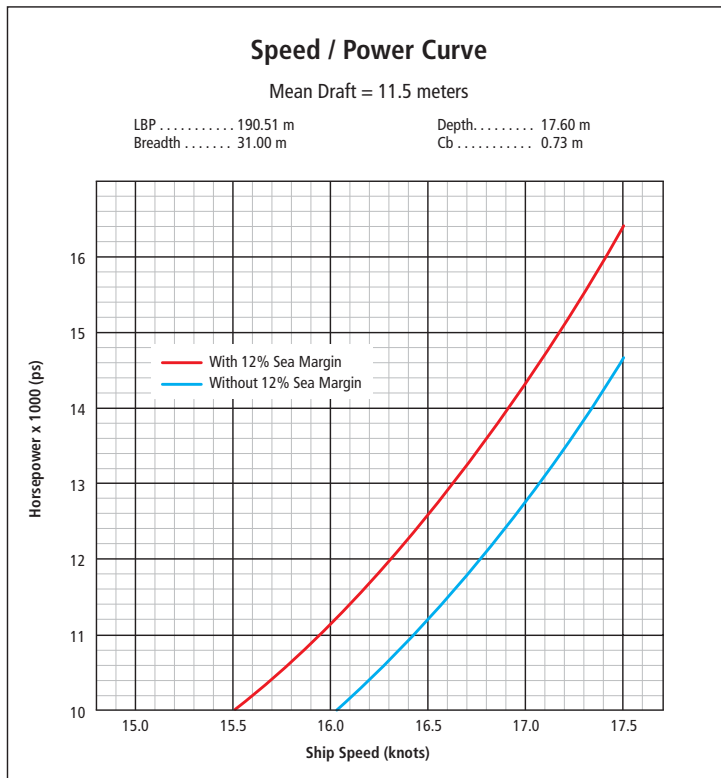

Figure 55. Typical Speed/power Curve



For ships trading on the voyage charter market, like many tankers, there is usually a speed agreed to in the contract of affreightment along with an estimated time of arrival (ETA). The ship must travel at this speed and arrive at a given time in order to avoid penalties to the owner. If there is a delay in terminal availability, and the ship must wait to discharge the cargo, then the charterer must pay a demurrage penalty. With these terms fixed in the contract there is little flexibility to adjust for changes in terminal availability or try and reduce emissions by slowing the vessel and arriving just in time for cargo discharge.

Further, since the charterer usually pays for the fuel, there is little incentive for the shipowner to slow down and risk late arrival. Tanker operators through their industry organizations, OCIMF and Intertanko, are addressing this with their virtual arrival scheme. This system includes provisions to share fuel cost savings and should give both parties suitable incentive to mutually arrange for slow steaming. This last point is the key: if slow steaming, or 'optimum' speed, is to gain widespread acceptance it will be necessary to give the fuel savings benefit to those who can control fuel consumption.

Finding Time in the Schedule

The greatest opportunities for slow steaming can be realized by minimizing the time the vessel spends in port. This can be addressed by improving the speed of cargo operations where shoreside cargo scheduling constraints are flexible. Investing

in better shipboard cargo gear, faster or more numerous shoreside cranes or ramps, additional stevedoring help, improving ship and shoreside mooring equipment and procedures, and improving terminal management for better and more efficient cargo handling can all be part of the plan for short port stays.

The difficulty is that the shipowner or charter party, to whom the benefits accrue, may not be the one controlling the terminal or its investments in technologies and people. Nevertheless, any options for reducing port time should be investigated for their potential investment return from lower speeds and fuel consumption at sea. An added benefit of shortening extended port time is reduced fouling and losses from such settlements. Fouling in general occurs during stagnant periods.

One of the other ways to squeeze more time out of the schedule is to use route planning services to avoid heavy weather and storms. These conditions cause the vessel to slow down but the added resistance due to waves means the power is not necessarily reduced at the lower speeds. Weather routing is discussed more fully below.

Optimization of Cargo Utilization

It is perhaps too obvious to be mentioned regularly in discussion of fuel economy, but the fuel spent for each ton of cargo carried can be reduced by maximizing the use of the vessel by carrying a full load of cargo. Saving fuel by sailing light is a false economy. Unfortunately, cargo utilization is often

simply a matter of market demand and there is little the owner can do except make sure he optimizes the size of the ship in a given market for the cargo volumes he can attract.

When there is sufficient cargo to fill the vessel, it is important to fully utilize the vessel's capacity. In order to do this the cargo planners and vessel's crew require tools to accurately and quickly calculate the drafts, trim, strength and stability of the loaded condition so that changes in cargo distribution can be made for better utilization. Integral with this is determining the efficient use of ballast, especially for achieving the optimum draft/trim.

Stowage options for cargo can also directly impact energy consumption. For example, placement of containers on deck accounting for overall aerodynamic form can reduce air resistance while underway. Locating reefer containers to minimize heat gain from the elements or optimizing liquid cargo temperature management can reduce generator or steam load.

Issues for Machinery Operating on Low Load

Slow steaming requires that the main engine and auxiliary systems operate at low loads, sometimes below standard manufacturer recommendations. This low load operation can cause accelerated wear of the engine and auxiliary components if not properly planned and executed. If loads less than 40 percent of MCR are expected for long periods of time adjustments to the engine and controls should be made. Each engine manufacturer has recommendations for these adjustments and can provide equipment and parts as needed. Electronically controlled engines have more 'range' and can operate at lower loads (down to 10 percent load) than mechanically controlled engines. In any case, it is necessary that low load operations remain within the load and limits recorded on the NOx Tier emission certificate (refer to Section 4, Machinery Technology).

Some of the maintenance issues that can occur as a result of long duration low load operation (say below 40 percent MCR) are:

- Soot deposits in exhaust gas boiler resulting in tube burning/melting
- Build-up of soot in turbochargers
- Cutting in/out of auxiliary blowers
- Increased heat load on components
- Excessive lube oil consumption

These effects can be mitigated with special fuel valves, exhaust gas boiler bypass, reductions in cylinder oil feed rate, decreasing turbocharger cleaning interval and adding cutout valves. These and other modifications are discussed in Section 4. It can also be helpful to intermittently run at high loads in order to 'blow out' soot deposits.

One additional consideration for very low load operation is that the specific fuel oil consumption (SFOC) of the engine actually increases at these loads. The engine can use 10 percent more fuel for each KW of power produced. This should be accounted for in the economic assessment of slow steaming options and potential fuel savings.

Weather Routing – Safe and Energy Efficient Route Selection

Savings	Savings vary depending on climate and voyage length, but can be significant in severe weather or where just in time arrival is possible.
Ship Type	All ships, but biggest improvements occur for ships on long routes in harsh climates.
New/Existing	All
Cost	Cost is based on a per voyage fee plus optional shipboard software purchase. The range is from a very basic weather forecast to a sophisticated and regularly updated information stream. \$200 per voyage to \$1,000 per voyage.

Planning vessel voyages according to expected weather has been an accepted practice for a very long time. For at least 50 years computers have been used to aid weather forecasting and evaluate simulated voyages. The fundamental goal is to select a course from the departure port to the destination port that provides the safest passage and reliable on-time arrival while taking into account actual wind, wave and current conditions expected during the voyage. The biggest change in recent years has been the shift in focus from a fast and safe route to a safe and energy efficient route. Weather routing is now closely tied to voyage performance management where the goal is achieving the 'optimum' speed with as little fuel consumption as possible while protecting the safety of the crew, passengers, ship and its cargo. As such it is part of the solution providing just-in-time logistics planning and it facilitates effective use of slow steaming.

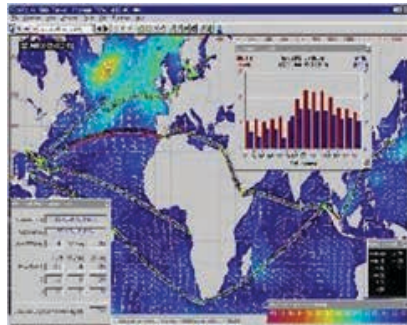
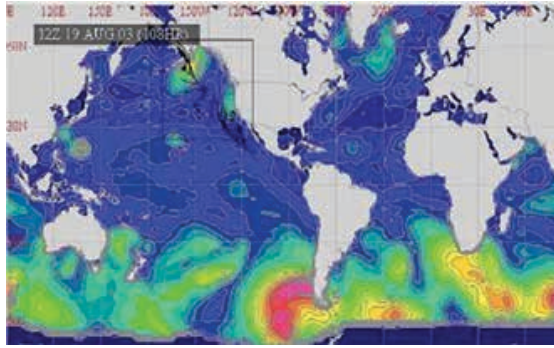

Figure 56. Sample Weather Routing SW Displays

Weather routing at its core is a service (not a product). It is provided to the operator by a company that has developed expertise in gathering and interpreting meteorological data, determining resulting wind and sea conditions and evaluating vessel responses in the predicted seaway. The service is only as good as the weather forecasting ability and meteorological experience of the service provider. There are continuing advancements in meteorology data collection, in mathematical modeling of the atmosphere and weather systems, and in the sophistication of ocean wave forecasting models based on the wind and current.

Each provider tries to distinguish itself with these often-times proprietary computer models and techniques. Vessel performance computer models are also a distinguishing factor. The most critical vessel performance prediction is the amount of speed reduction in a seaway. Some providers use a generic vessel model that matches the type and size of the ship to make this prediction. Others use the exact geometric characteristics of the subject ship. The calculation algorithm can be derived from model test data, a simple empirical rule, full-scale measurements or be based on direct calculation of ship motions and added resistance.

The weather routing service is available in various forms and with a variety of complimentary features. For instance, the weather routing information

could simply be communicated to the ship via email. Or there could be shipboard and/or shoreside computer applications that allow a wide range of vessel and fleet management functions. Added features that are becoming quite common include powerful shipboard computer applications to visually display route and vessel performance information and allow the Master to interact with the performance prediction tool.

Some tools endeavor to predict the actual vessel motions and hull girder stress and alert the crew to threshold exceedance (such as conditions where roll, slamming or hull stresses are too high). These tools predict changes in the ship response to heading/course changes allowing the Master to make immediate course corrections for severe situations. More advanced systems can incorporate user-specified environmental or safety constraints and voluntary speed reduction and heading change thresholds in the voyage selection algorithms. Shoreside fleet management systems that track each vessel are also now common, tracking the vessel's planned versus actual course, and key performance indicators. Integration with third-party products such as Google Earth makes fleet tracking easier and widely available.

How it Works

The route selection process involves a simulation of numerous possible routes taking into account the wind/wave/current condition along the track. The climate data is updated at regular intervals for the vessel's predicted position and time and all the safety limits are checked. For the purposes of route selection the safety constraint or target includes limits on vessel motions for passenger/crew comfort as well as cargo securing. There may also be limits related to a risk for structural damage due to slamming or green water impact on deck. Difficulty in course-keeping at certain heading and other operational guidance can be considered by the more sophisticated voyage modeling tools.

The vessel's ability to maintain speed given the heading and sea state is calculated using the vessel performance model. The speed and heading over the bottom is then determined and the predicted progress along the route recorded. If the safety limits are not satisfied at any point the route may be rejected and another route (heading, speed) selected.

Routing is based on different types of weather and meteorological forecasts. Short range

weather forecasts out three to five days are now generally available and reliable. They are based on current observations, including surface and upper air pressures measurements, wave buoys and satellite data collection, and meteorological models. Extending the forecasts out to 14 days is usually done by matching historical weather patterns and global wave models to current conditions and using these to make predictions on sea states. The extended forecasts allow longer range study of possible course deviations, such as routing around developing storm systems.

Regardless of the forecast, horizon-planned voyage routes should always be updated regularly (as often as twice daily) with information from vessel weather observations, current position and the current short-term weather forecasts at the position. Direct and frequent communication between the weather routing service and the ships at sea not only allows for this regular route update, but also allows the ship to receive alerts on expected storm severity and duration as well as expected vessel response (motions, speed slow down, etc.). Also very useful is feedback to the weather routing service at the end of the voyage regarding weather and vessel performance to help them update their models.

Conclusion

Weather routing is most beneficial on longer voyages (over about 1,500 NM) where the route is navigationally unrestricted so that there is a choice of routes, and where weather is a factor on vessel performance. It is currently more commonly used on high-speed, fine-form ships in liner services. These ships can be more susceptible to damage and significant slowdown in a sea way. Still, slower full form ships can achieve some benefits, especially when combined with charter agreements that allow just-in-time arrival. In this case, simple weather guidance that helps avoid storms and minimizes average voyage speed would be sufficient.

When selecting a service provider, the operator should take into consideration the provider’s experience and the sophistication of its computer models for obtaining reliable voyage plans. The number of services offered is considerable. The operator is well advised to shop around carefully, and may wish to consider hiring an outside expert to find the most suitable options based on specific needs.

Trim/Draft Optimization

Savings	1 to 2 percent reduction in propulsion fuel consumption.
Ship Type	All ships, but biggest improvements occur for ships on long routes.
New/Existing	New and existing
Cost	Cost to develop the data is \$50,000 to \$100,000 (total for all ships of similar design) using model tests. Cost to use the data effectively involves shipboard software tools \$500 to \$5,000 per ship. In-service cost is limited to energy costs for pumping ballast and cargo planning time to optimize cargo distribution.

Hull forms are traditionally designed and optimized around one or two primary drafts assuming zero trim. The complex flow regimes at the bow and stern are carefully tuned for these drafts to achieve the least resistance. If the water level at the bow or stern is even slightly different (for example 0.5 m) than the design point, the resistance can increase enough to noticeably increase fuel consumption. Sometimes lighter drafts at the wrong trim can have higher resistance than a deeper draft at the proper trim.

A vessel in service may sail a significant portion of its voyages at drafts other than the design draft. Likewise, the distribution of cargo, ballast and consumables often leads to trims different than that assumed during design of the hull. Even newer ship designs which are being optimized around a larger range of operating drafts will sail at times beyond the range of optimized drafts and trims. What is critical for best fuel efficiency is providing the Master and cargo planners with information that allows them to choose the best combination of draft and trim for the cargo deadweight and consumables they must carry. Distributing cargo and consumables to the extent possible and selecting the proper amount and location of ballast then becomes the mechanism to achieving optimum draft and trim for the given voyage leg.

In recent years a large number of trim optimization tools have appeared on the market. They typically provide a simple shipboard software application that displays the most efficient trim for a given draft and allows the Master to adjust ballast and consumables to gain some improvement. The better tools make it easy to optimize the quantity of ballast as well as its distribution. They may be integrated with the loading instrument and/

or draft gauges for direct measurement. It is also advantageous if the cargo planners, having significant control over cargo distribution and vessel trim, have access to the trim optimizing tools, as illustrated in Figure 57.

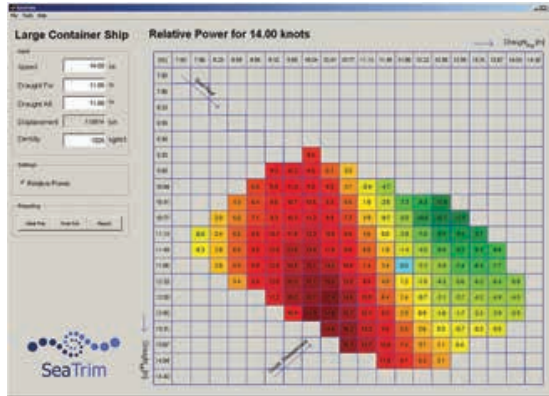

Figure 57. Sample Optimum Trim Calculator

The big difference in trim optimization tools is how they determine the optimum trim at a given draft. The methods vary significantly and there is a disparity of opinion about which approaches are the most likely to give accurate, real-world guidance on the most efficient trim. The methods can be broadly classified as theoretical calculations or testing, and in-service measurements. Within these categories there are also variations.

Theoretical: Model Tests and Calculations

The traditional approach for determining optimum trim is to rely on model tests in calm water to evaluate the resistance over a full matrix of drafts and trims. A set of curves are developed that clearly indicates the trim offering the least resistance at a given draft. This data is then easily incorporated into the shipboard tool.

These tests are relatively common and most basins have regular procedures and recent experiences to guide their work. Optimum trim tests must be set up to measure small variations in power. The normally expected range of variation is just 0 to 4 percent of full installed power. To distinguish these small differences reliably the size of the model and the experience of the basin with that size model and type of test are important. This is especially true when self-propulsion tests are involved and the variation of flow over the propeller is critical to the final result. Large size models result in fewer problems with ‘scale effects’ because they

are closer to true size and the flow behavior more closely matches full-scale behavior. Unfortunately, large models and bigger basins result in higher costs.

Self-propulsion tests are recommended (in addition to or in place of towed resistance tests) because they capture the change in wake pattern and thrust deduction with trim and draft. These two factors are a component of overall hull efficiency and are known to change with trim/draft. Although the change is small, it can represent a significant portion of the overall change in required power with trim. Therefore, self-propulsion tests are deemed necessary for reliable optimum trim results.

It is recommended that these tests be done at the newbuilding stage when a suitable model already likely exists. For ships in service that require a new model, the total cost for optimum trim tests is in the range of \$50,000 to \$100,000.

The use of CFD programs to supplement or replace the traditional model tests has been gaining in popularity as the codes have become more sophisticated, computing power has increased and more experience has been gained with CFD for power prediction. For this application codes based on ‘potential flow’ theory are generally acknowledged as the best available technology for capturing the small variations in resistance around the bow and stern forms. They generally do a good job of prediction yet where there are significant changes in flow, such as at the bottom of an immersed transom, the CFD codes can fail to properly predict the resistance. The skills and experience of those doing the CFD analysis are important to properly running the analysis, understanding its limitations and interpreting the results.

The approach with CFD is to evaluate the same matrix of drafts and trim with computation rather than physical tests. As with model tests, there is an outstanding question of how motions in a seaway, especially pitch, but also yaw and sway, impact the theoretical calm water predictions. Currently most believe that vessel motions will not alter the calm water optimum point, even though the calm water flow is disturbed and overall resistance increases as motions increase. An alternative approach that tries to eliminate this uncertainty between calm water predictions and in-service conditions are those that rely on in-service measurements to figure the optimum trim.

In-service Measurements

Measuring actual performance (fuel consumption, power and speed) and the corresponding draft and trim while underway provides data that can be used to generate optimum trim tables. While conceptually simple and direct, this approach is difficult to implement with sufficient accuracy to be useful. By using full scale measurements there is no way to isolate the effects of trim/draft on fuel consumption from the other myriad of factors that add to resistance. The resistance differences due to trim are quite small and can be lost in the noise of fuel flow meters or tank sounding irregularities, main engine power calculations, added resistance due to waves and weather, reliable speed through-the-water measurements, etc. Analytical methods are required to dissect these elements and without careful, diligent and proper accounting of these other factors, the full scale measurements may tell the wrong story about optimum trim and draft.

One method to avoid the complexities of these other factors is to use accurate fuel consumption monitoring tools and simply try different trims and draft by moving ballast. As long as wind/ weather conditions remain constant the Master will eventually arrive at the best draft/trim for that particular loading condition, sea state and heading. As draft and trim change with fuel consumption the process will have to be repeated. Clearly this is a time consuming and inefficient process, but one that can be effective on long runs in mild conditions. If a record of these full scale trials is maintained it can be referenced for future use. With this system it is very difficult to optimize the draft and trim together.

Another approach that is more common is to perform full-scale measurements in controlled conditions. This essentially mimics what is done in the model basin. The test can be done during normal runs in service where the weather is calm, or special test runs can be set up in areas near shore and with close support of engineering staffs. The conditions need to reduce or eliminate factors that impact resistance or performance measurement accuracy and all the conditions at the time of the test must be easily measurable and quantifiable.

While small, the reduction in resistance at an optimum trim can quickly add up to 1 to 2 percent of fuel costs. This helps justify the investment in model tests, CFD calculations or full-scale measures, and associated software tools. The payback period can be just a matter of months if the vessel had been operating on long voyages with off-optimum conditions and/or high-power consumption.

Autopilot Improvements

Savings	Up to 1 percent reduction in propulsion fuel consumption.
Ship Type	All ships, but biggest improvements occur for ships on long routes in harsh climates.
New/Existing	All
Cost	The operator can make simple adjustments in existing linear autopilots (~zero cost). Cost for fully adaptive autopilot, useful for heavy weather conditions or directionally unstable ships, \$20,000.



Rudder movements add drag to the hull and increase resistance. Minimizing the number of times the rudder is used and the amount of rudder angle that is applied to maintain course or execute a change of course will save fuel. This is true under manual steering as well as when an autopilot is engaged. When considering how much rudder to apply the controlling constraint is allowable course deviation. Allowing large course deviations will reduce the rudder use and angular movement, but may also increase the distance sailed. Making wise choices about this constraint and having an autopilot that can minimize rudder use in any type of seaway may result in up to a 1 percent savings in fuel over a poorly tuned autopilot or manual steering.

Conventional autopilots rely on simple, usually linear, relationships between rudder angle and rate of change of heading. These are good for directionally stable hull forms and when rudder angles are small. Indeed, some owners have found that their directionally stable ships and/or their benign route (good weather) allow them to minimize rudder use with the simpler linear type autopilots. A rule of thumb for good performance is no more than six to ten small rudder movements per minute, and an observed vessel wake that is straight.

Where the vessel is directionally unstable and/or there are large vessel dynamics (due to wind, waves and current), large rudder angles can be required. In addition, changes in draft, speed and water depth can change the fundamental relationships between rudder angle and vessel response (turning rate). An adaptive system takes feedback on the rate of response of the ship to a given rudder angle and automatically adjusts, or 'adapts' the steering control model. A steering model adapted to actual conditions helps prevent excessively frequent or large rudder motions (so called hunting) in course-keeping and course-changing modes.

It is the software in autopilot that makes the key decisions and manufacturers often have their own proprietary mathematical approach to this adaptive course control model. Much has been written by mathematicians and control system experts on this issue but not much is shared by the equipment vendors. When selecting an adaptive steering system one should judge its performance based on qualities such as a high accuracy of course-keeping, shorter time of rudder actions with smaller angles, lower swing of the ship's bow even in strong waves and winds, and higher course turning speed. By

measuring the frequency of rudder movements and the rudder angles required at sea in course-keeping mode it is possible to assess, at least on a qualitative basis, how well the autopilot is performing.

While not as important as the adaptive system of the autopilot and its ability to auto-tune to the weather and load conditions, the selection of steering strategies can have an impact on fuel efficiency. The autopilots typically allow the user to select limits on rudder control or heading, for instance, the maximum heading deviation that is allowed. These selections should be based on total fuel efficiency and include consideration of distance sailed. A voyage routing or performance tool can integrate these options into the overall course prediction.

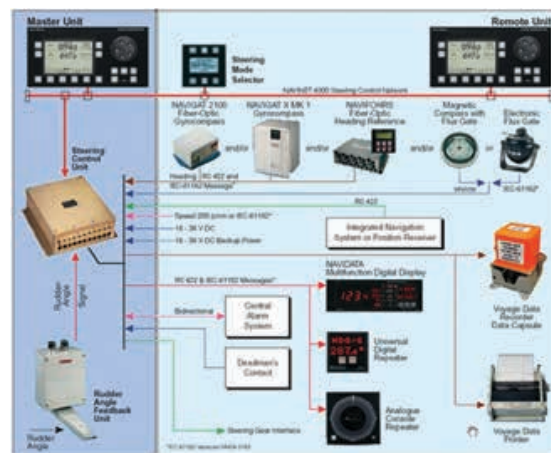

Figure 58. Self-tuning Adaptive Heading Control System (Sperry's NAVIPILOT 4000)

Hull and Propeller Condition Management

Taking care of the propeller and underwater portions of the hull is all about minimizing roughness. Regular in-service cleaning to remove fouling organisms (which are a form of roughness) is clearly beneficial unless it is carried out in a way that results in a damaged coating or one that has been 'roughed' up. From a fuel efficiency point of view, the emphasis should be on hull and propeller roughness management and not just on the control of fouling.

Hull Roughness and Its Impact on Resistance

Resistance of a ship's hull is composed of frictional and wavemaking (or form) resistance. Frictional resistance, based on the wetted surface of the

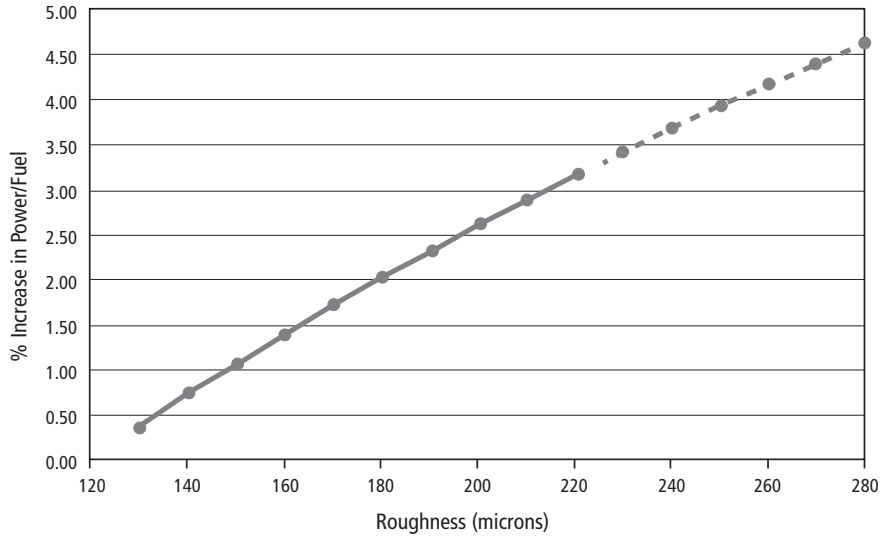

Figure 59. Increase in Fuel Consumption for a Fast Containership with Increasing Roughness (from International Paint Hull Roughness Penalty Calculator)

hull and appendages, is the primary component of total resistance, especially for full form ships. A tanker at its design speed will use the majority of its fuel overcoming frictional resistance when in calm water. For high-speed, fine-form ships wavemaking resistance becomes more important. However, frictional resistance still dominates the total resistance. The size of the frictional resistance is dramatically impacted by the roughness of the surface exposed to the flow. It has been suggested that each 10 µm to 20 µm of additional roughness can increase total hull resistance by about 1 percent for full form ships and about 0.5 percent for fine-form ships at high speeds. This is shown in Figure 59.

It is not uncommon for a new ship to be delivered with surface roughness as low as 75 µm and later in life enter the drydock with a roughness of 250 µm. Historical records have shown that even with good maintenance practices average hull roughness can increase by 10 to 25 µm per year, depending on the

Table 5. Types of Surface Roughness

	Physical Roughness (Surface Profile)	Biological Roughness (Fouling)
Macro (> 1 mm)	Weld beads, plate waviness, significant corrosion, deep pits, plate laps, mechanical damage	Animal (shell, barnacles, worms, etc.) or weed fouling
Micro (< 1 mm)	Poor coating condition, minor corrosion, shallow pits, steel plate surface profile	Slime fouling, algae

hull coating system, even when fouling is not included. Even if the rate of increase in resistance for roughness shown in Figure 59 is a bit high, the potential savings from keeping a smooth hull are significant.

Surface roughness comes in many forms and from many sources which can be broadly categorized as physical or biological. These sources are further grouped based on size as either micro-

roughness (less than 1 mm) or macro-roughness (greater than 1 mm), as shown in Table 4.

The physical micro-roughness can be increased in service by mechanical damage, failure of the applied coating (peeling, blistering, cracking, dirt inclusion, etc.), and even improper preparation of the surface and/or improper application of a new coating. For instance, overly aggressive blasting, inadequate repairs to the previously applied coating, dry overspray and uneven dry film thickness can increase the surface roughness. After the first drydocking post-delivery where a spot treatment and a full coat of fresh antifouling has been applied, it is possible to see roughness of 250 µm and more.

Based on the rule of thumb for added resistance a ship with this hull surface (even when no fouling is present), 3 to 4 percent more fuel may be used than at delivery. The consequence of improper coating maintenance and application can be catastrophic

from a hull resistance point of view. For this reason, due care must be taken when drydocking a ship so that the paint specification is robust, there is good quality control to monitor surface preparation and paint application, and the painters are well trained.

Biological roughness (fouling) also has a significant impact on resistance, even at the micro

level (slime, algae, etc.). Predictions based on model tests of a light displacement fine-form ship indicate that a light slime covering the entire wetted surface can increase total resistance 7 to 9 percent. A heavy slime results in a total increase on the order of 15 to 18 percent. Small barnacles and weeds push this up to a 20 to 30 percent increase in total resistance.

Hull Roughness Management

In order to minimize a ship's frictional resistance the owner must address both physical and biological roughness. There should be a smooth surface to start with and it should be maintained at proper intervals. Mechanical damage and coating failures have to be addressed and fouling has to be controlled. Unfortunately, there are so many options for coating systems and cleaning regimes it is very difficult to decipher all the claims, costs and benefits. Regardless of what system is selected to manage roughness, care should be taken to make sure the cleaning methodology is compatible with and compliments the coating system. There is little sense in putting on a very smooth and expensive antifouling and then scrubbing it off with an overly aggressive cleaning campaign.

Hull Antifouling Coatings

Savings	When applied in combination with appropriate hull cleaning/maintenance, a high quality coating can yield an average reduction up to 3 to 4 percent in propulsion fuel consumption. Recoating a rough hull can yield 10 to 12 percent decrease in fuel costs.
Ship Type	All
New/Existing	All
Cost	A full blast to remove surface roughness and application of primer, anticorrosive, and high quality antifouling can cost \$10/m ² (vary between \$6 and \$17 in the Far East), or about \$300k for a typical VLCC.

There are currently three different coating types in wide usage and they offer different resistance to fouling, have a different impact on hull roughness, and have different requirements for cleaning frequency. Regardless of the type of coating, it is also worth noting that the amount of fouling can vary greatly with trading pattern and operational profile.

Controlled Depletion Polymer (CDP) – A traditional antifouling type based on a water soluble natural or synthetic pine rosin mixed with

a biocide. An insoluble reinforcing polymer resin is added to create a skeleton to give the rosin better mechanical properties. The controlled dissolution of the rosin matrix releases the biocides. Over time a buildup of insoluble materials at the surface in a leached layer slows the release of biocide and makes recoating difficult. Moving water (or cleaning) is required to wear off this co-resin skeleton and release the next layer of coating and biocide. Typical life before recoating is 3 years, but because of the buildup of this leached layer and reduced biocide release microfouling (green slime or weeds) can become a problem in less than two years. The average hull roughness (AHR) increase is estimated at about 40 µm per year in surface profile, but this can vary greatly.

Self-polishing Copolymer (SPC) – An insoluble metallic or organic synthetic polymer (e.g. copper-acrylate or silyl-acrylate) that contains a biocide. Through a chemical reaction – hydrolysis – the polymer becomes soluble. Its subsequent dissolution releases the biocide. The chemical reaction provides good control of the rate of dissolution and results in a much thinner leached layer and smoother surface profile than possible with CDPs. No ship movement is required as there is no residual 'skeleton' and the surface is actually self-smoothing. Five years of service for high quality systems can be achieved. AHR increase is estimated at about 20 µm per year.

Foul-release Coating – A biocide-free coating that uses nonstick properties to control fouling. It is usually silicone or fluoro-silicone based and designed to shed any micro or macro growth when the vessel is underway. For slower vessels (less than 15 knots) this is a challenge for even the best coatings so some 'soft' cleaning is usually required to remove the microfouling. If the vessel is stationary for some time barnacles and other macro-size biota can become attached. Only with sufficient vessel speed will they be washed free of the surface. Achieving a full release of all fouling has proven to be a challenge in some cases. The coating gains some of its effectiveness from its extremely smooth surface and this must be maintained for best performance.

Roughness in a foul-release coating will reduce its ability to discourage adhesion and slime/microfouling can take hold. Mechanical damage from fenders and tugs is especially critical

for these types of coatings requiring special care in operations as damaged parts have no fouling discouraging properties at all. AHR increase is estimated at 5 µm per year, but this is based on a very limited service experience.

When searching for the best coating system it is important to remember the best result will be realized with a coating that provides a smooth surface that can be reasonably maintained in its smooth state, and that prevents adhesion of fouling organisms. It is not simply a matter of ‘putting on a fresh coat’. The coating must be applied properly, monitored and managed to maintain its best qualities. If done correctly, the right coating upgrade can offer a quick, simple and dramatic performance improvement.

Hull Cleaning

Savings	Cleaning a light slime can yield up to 7 to 9 percent reduction in propulsion fuel consumption. Cleaning a heavy slime up to 15 to 18 percent, and cleaning a heavy macro fouling up to 20 to 30 percent.
Ship Type	All ships
New/Existing	Ships in service
Cost	Hull cleaning by divers or robot \$1.5/m ² to \$2.5/m ² in the Far East, or about \$50k for a VLCC if all areas are cleaned - higher cost in US and Europe.

The purpose of in-service, underwater hull cleaning is to remove biological roughness or fouling. Depending on the coating, the cleaning process can have the added benefit of rejuvenating the active biocide layer. Proper cleaning removes all traces of fouling and does not remove or damage the coating or cause any increased surface roughness.

Underwater cleaning is accomplished by a diver with a manually operated scrubber incorporating some type of rotating brushes or pads. Some vendors offer cleaning vehicles that can be remotely operated from the surface. Depending on the degree and type of fouling to be removed a diver squad (often three men) can typically clean 2,000 m² per hour of flat surfaces (less on the bow and stern areas). The underwater cleaning vendor will typically provide sufficient diver squads to clean the area requested in six to 12 hours, during normal ship stops (bunkering, anchorage, waiting for canal passage, etc.).

In the case when only partial cleaning is possible due to operational circumstances, the areas should be cleaned in the following order to provide the best performance enhancement:

- Propeller (see following section)
- Forward third of hull
- Remainder of hull working from forward to aft

Some underwater cleaning equipment advertises that it can remove barnacles up to 50 mm in diameter. To do this on a CDP-coated surface requires very stiff brushes and aggressive pressure and rotational speed. In such a scenario it is difficult to remove heavy fouling without removing a significant amount of paint. If the antifouling is applied in different colored layers then these colors can be used to monitor paint removal during cleaning. SPCs have a thinner leached layer than CDPs so the cleaning should use a less aggressive technique. Cleaning of foul-release coatings should only be done with a light touch and soft pads. In all cases, follow the paint manufacturer’s recommendations carefully, review these with the cleaning vendor and document the results with good underwater photography of the cleaned surface. Ideally, on a freshly cleaned surface there should be no evidence of scratches, swirl marks or abrasion of weld seams that expose base coats or bare steel.

The most critical issue to address is when and how often cleaning should be done. A proactive approach that preempts any type of widespread macrofouling is always warranted simply because the cost of having such fouling present outweighs the cost of cleaning by a very large margin. Regular cleaning of microfouling is also often cost effective if the proper cleaning technique is used so that the surface roughness is not degraded and coating material is not removed.



Figure 60. Example of Slime Fouling

For best results, the scheduling of cleaning should be based either on monitoring of performance indicators (like fuel consumption, see below) or on regular pre-cleaning inspections. In both cases a threshold is established that identifies when cleaning is economically justified. For visual inspections the threshold includes the percentage of the hull surface that is fouled and the type of fouling. Regular inspection, photographs and roughness measurements would be a prudent way to monitor the impact of cleaning and the condition of the coating. The solution to this critical issue is to monitor and to know the condition of the underwater hull, to understand the consequence of the condition seen, and to take appropriate action.

When planning for hull cleaning it is also important to be aware of other regulatory instruments that govern when it can be done. The IMO at the Marine Environment Protection Committee (MEPC) in July 2011 adopted as a voluntary instrument MEPC.207(62) *Guidelines for the Control and Management of Ships' Biofouling to Minimize the Transfer of Invasive Aquatic Species*. These guidelines, if followed, would greatly decrease the risk for the spread of aquatic species into new areas, and it focuses on so called niche areas (sea chests, thrust tunnels, etc.) and general areas.

In addition to this, California in April of 2011 announced the intent on regulating biofouling on ships from 2013. The regulation is still under review, and it is not clear at this time exactly what the requirements will be. In the present draft the regulation ranks fouling on a scale from 0 to 6 and requires all ships calling their ports to have no fouling beyond Rank 1 (microfouling or slime only) on general areas, and no fouling beyond Rank 2 (minor amounts of macrofouling, barnacles, weed, tubeworms, etc.).

It is clear that while the proposed regulations undoubtedly will lead to added cost for ship maintenance and operation, it can also reduce the hull drag and fuel consumption if it is well managed, and as such result in reduced total cost. As discussed the cost of fouling (even slime fouling), is now much better known, and if these regulations and guidelines are followed the net result could very well be a positive for the shipowner.

Propeller Roughness Management

Savings	Cleaning /polishing the propeller can lead to a reduction in propulsion fuel consumption up to 6 percent.
Ship Type	All
New/Existing	Ships in service
Cost	Divers can clean a 10 m diameter for five blade propeller in about 3-4 hours for \$3k in the Far East, double the cost in Europe.

In addition to the hull surface, propellers suffer degradation in performance due to surface roughness. The absolute magnitude of the reduction in ship efficiency due to propeller roughness is less than experienced with a rough hull surface, but it still has been estimated that it could cause an increase of as much as 6 percent of total fuel consumption. Further, the efficiency loss per unit of affected area is greater, making the economics of cleaning and polishing the propeller very compelling.

On a propeller, physical surface roughness is created by corrosion (on both sides of the blades and heavier in the outer half region); cavitation erosion (concentrated near the tips and back of blade); and impingement attack (on the leading edge and closer to the tips). Improper maintenance can also increase roughness; this could be overspray from hull coatings, grinding/polishing that is too aggressive, or nicked edges.

Even though propellers are commonly 70 percent copper, fouling normally is a problem because the copper is not active and available to some fouling organisms as a biocide, namely the microfouling species. Fouling normally forms within a year, and can be highly variable. But in the worst cases slime, algae and even barnacles and tube worms can be found on propellers that are not regularly cleaned. It is generally believed that fouling can be a bigger share of performance degradation than initial roughness. For either roughness or fouling the impact is more critical toward the tips and on the leading edges.

Propeller Polishing

In service, regular underwater cleaning and reconditioning of the surface of a propeller is done with a small rotating disk that can easily conform to the complex shapes of the blades without gouging the surface. This tool removes all fouling and produces a very fine surface scratch pattern

in the range of 1 to 2 μm . This is similar to what would be expected of a newly manufactured blade surface. Any large nicks or damage, especially to the leading edges or tips, should also be repaired and smoothed out.

To easily assess the condition of the surface it is common to use a comparison guide like that shown in Figure 61 that provides actual surface roughness examples for visual and tactile comparison. The specimens are labeled A to F, with A and B representing expectations for the roughness after polishing. Studies indicate that propellers with average blade roughness corresponding to Grades C, D and F can have 3, 5 and 6 percent lower propulsive efficiencies, respectively, than Grades A and B. So, polishing a very rough blade (with average surface roughness greater than 30 μm , Grade F) can lead to a 6 percent reduction in fuel consumption. The guide in Figure 61 indicates where differential polishing leads to the best gains.

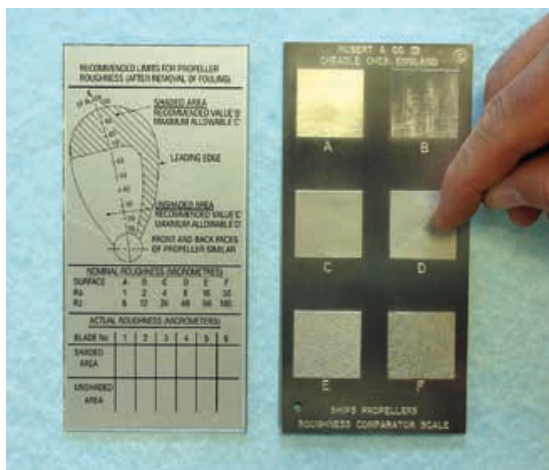

Figure 61. Rubert Propeller Roughness Comparator – Diver's Version

Propeller Coatings

There have been important advances in foul-release coatings for propeller blades made in the last 15 years. These new coatings can have better surface properties than the polished propeller surface. Even though they have evolved with very good adhesion properties, the coatings are subject to damage by cavitation erosion and leading edge impingement. The cause of the damage to the coating also prevents any fouling and so the localized coating damage does not affect performance to any significant degree.

The propeller coatings offer protection against corrosion-induced roughness and fouling. With an

initial smoothness equivalent to a highly polished but uncoated blade (Rubert A or B) the foul-release coating reduces natural degradation of the surface and losses in efficiency, and therefore, the need for polishing and smoothing. The coating also reduces the galvanic corrosion potential on the rudder and aft body area which reduces the anode load. Fewer anodes means a reduction in frictional resistance. They do, however, easily damage from contact.

Condition-based Hull and Propeller Maintenance

Knowing when to clean the hull and the propeller is the goal of condition-based surface maintenance. This can be done in two ways: measure/observe actual hull and propeller roughness/fouling and compare with threshold values that indicate when cleaning is warranted; or use performance-based systems that track changes in fuel consumption and main engine power to identify degrading surface conditions. The first method is based on a direct assessment of the actual surface condition which must be done by divers in port. By correlating the roughness and degree of fouling to losses in efficiency and increases in fuel consumption, the owner can make an economic decision on when hull cleaning and/or propeller polishing should be done.

The use of performance monitoring systems is attractive because it measures fuel consumption directly and while underway without the need for special arrangements in port. As with in-service measurements for optimum trim, it is necessary to isolate the effects on fuel consumption of the parameters being studied. This is most reasonably done by collecting records of fuel consumption in controlled or at least repeatable voyage conditions. The data then has to be either normalized to remove effects of draft, trim, wind and waves, or compared with similar conditions in earlier tests. These approaches to performance monitoring have been in use for many years and there are quite a few vendors and products that endeavor to perform this function. Nevertheless, it remains difficult to use these methods to reliably discern the small gains or losses in efficiency due to light fouling that are now often the threshold for cleaning decisions. With these methods it is also not possible to separate the propeller condition from the hull condition.

In summary, the use of performance monitoring tools is generally recommended along with accurate fuel measurement techniques, but these should not be relied on exclusively to indicate when hull

cleaning and propeller polishing are necessary. Regular visual inspections that supplement a long-term record of coating types and applications, and roughness and fouling patterns, and rate the best way to confidently maintain the condition of these critical surfaces.

Ship System Management

Ships in operation should also pay due consideration to the energy efficiency of shipboard machinery and equipment. Optimizing the use and operation of mechanical and electrical systems can offer improvements in fuel consumption as significant as hull cleaning or voyage planning. Options for reducing onboard power demand are discussed below. In addition, there is a discussion of the one system that is vital to every ship efficiency measure: the fuel consumption monitoring equipment and related procedures

Reducing Onboard Power Demand

All of the equipment and machinery on board are independent energy consumers and they can each be tuned to perform to their optimum efficiency based on manufacturer's guidelines. Alternatively, components can be replaced with higher efficiency models or ones that are a better match for the load or service condition. Proper and timely maintenance is also important for optimum performance.

The first step in making improvements in efficiency is evaluating the current condition:

- Get a good baseline of current energy usage of each unit/system by doing an energy audit of shipboard consumers.
- Identify which consumers are not operating at peak efficiency or which ones are improperly matched to their load and service.
- Review findings and do a cost/benefit analysis on upgrading equipment to achieve better efficiencies.
- Prioritize these changes by the size of the efficiency gain and ease of remediation.

When performing this audit the largest consumers down to the smallest pump motor or lighting system should be considered. Some of the more obvious systems requiring careful attention are the main engine (including turbochargers, fuel purification, lube oil and cooling systems, etc.); SSDG engines and systems; steam production; and cargo heating. But the electrical consumers can also



be quite significant, such as pumps, fans, lights, HVAC units, cargo ventilation and refrigeration and electronic systems.

The energy audit and component optimization should, however, not only be done for each in isolation. These components are part of a complex and completely interrelated power system. So, proper onboard energy management requires an understanding of how the performance of each component impacts the other. This includes an understanding of how vessel operating scenarios and loads impact the main engine and generator loads, for example. The operator should consider power balancing of electrical loads for different ship operations (in port, at sea, etc.) to verify the SSDGs are operating at the most fuel-efficient load condition. Alternatively, operators can shut down or slow down non-essential pumps, fans, lights, etc. as vessel operations allow. By doing this it will be possible to make component improvements that are complimentary to overall vessel efficiency improvements.

Fuel Consumption Measuring and Reporting

Every vessel measures and records fuel consumption for proper bunker management – the ordering of the correct quantities of the right fuel at the lowest cost. This also provides data for home office management of fleet costs, total CO₂ reporting and gross comparisons of ship energy performance. Unfortunately, the data collected

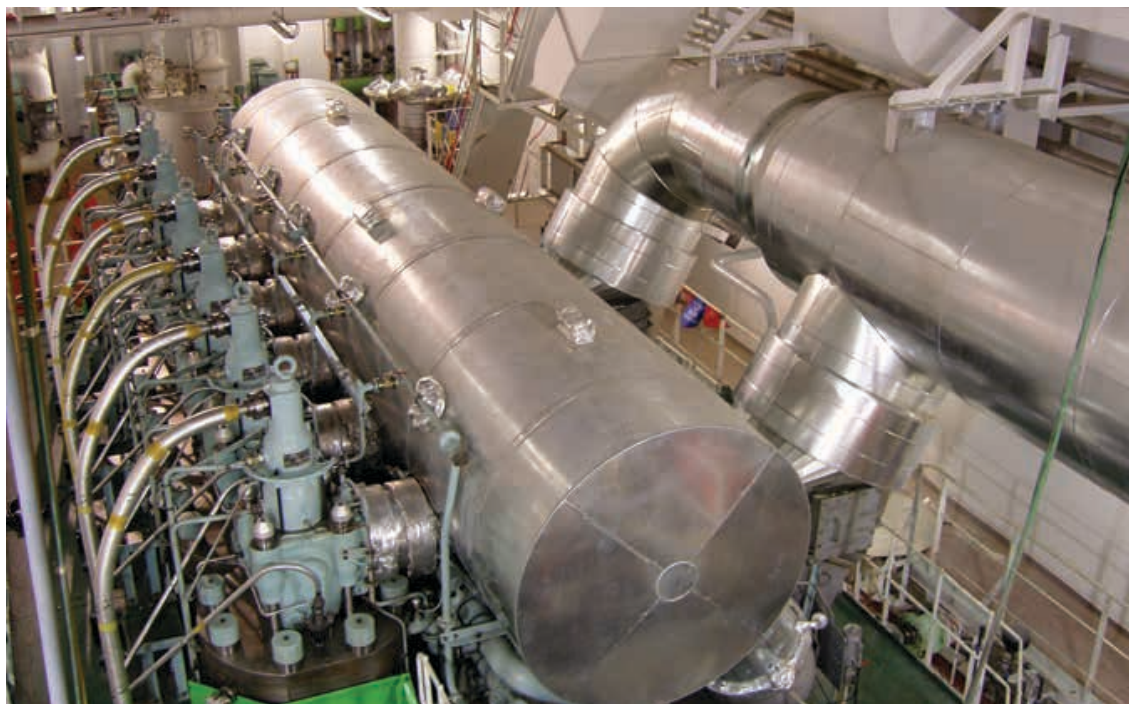

for this purpose is usually defined by the needs of the financial managers. It is usually based on tank level measurements at specific times that are not necessarily related to a vessel's operating condition (e.g. noon report, end of month or voyage). This measure of fuel consumption is of limited use for evaluation and improvement of the energy efficiency of a ship or class of ships. In order to evaluate competing energy-saving measures or accurately compare a ship's overall efficiencies the ability to measure small differences in fuel consumption and/or power used to a high accuracy and with consistency is required.

For proper energy efficiency management the owner should look to develop a fuel consumption measuring system and process that can address both bunker management and energy efficiency measures in a coordinated manner and with acceptable accuracy. The two goals can be achieved separately, but with much redundant effort and usually general confusion when trying to reconcile the two records.

The ideal combined system should provide for measuring and reporting of:

- Tank-level status (onboard quantities) and bunker and sludge discharge events;
- Fuel mass flow and power delivered for each consumer at 'high' frequency; and

- Related voyage and vessel operating information (speed through the water, distance sailed, location, weather, engine RPM, draft, trim, etc.).

The tank-level status provides a snapshot of onboard quantities and by comparing snapshots at different times fuel consumption can be summarized over any desired period (voyage legs, entire voyages, accounting periods, seasons or annual). The high frequency measurement of fuel mass flow to each consumer together with simultaneous power output of each is required to record data useful for measuring efficiency.

The two measuring approaches can be regularly checked against each other for consistent results. To meet the needs of accurate fuel efficiency monitoring the following factors should be considered:

- Number, type and location of fuel meters – An independent and direct measurement of main engine, diesel generators and boilers and all fuels in use is recommended. Fuel meters that can handle varying temperature and viscosity are preferred (such as Coriolis-based mass flow meters).
- Frequency of fuel measurements –The measurement interval should include high frequency intervals (every minute); longer term intervals (daily, monthly, voyage, period or annual); as well as at key voyage events.

- Fuel quality (characteristics), third-party testing and recordkeeping – The testing should include characteristics that have a direct impact on energy use such as calorific value and percent water.
- The definition of voyage events for common navigational orders that cause changes in fuel consumption – A consistent understanding and method for recording these terms is required in order to properly dissect and comprehend fuel consumption figures:

at sea	=	departure port to arrival port (at pilot station)
maneuvering (at arrival)	=	arrival to 'finish with engine'
in port	=	finish with engine to standby
maneuvering (at departure)	=	standby to departure (pilot station)
engine order	=	any command given to change speed

- The method for accurate and reliable engine power measurement and recording – Will this be from a shaft torque meter, the engine control system, or some other method/source?
- The installation of remote sensing tank level and temperature gauges for convenient, accurate and reliable measurements in the fuel tanks.
- Data collection software tool to encourage regular and consistent use – This should automate data retrieval from equipment and control systems as well as facilitate manual entry of data from the Deck and Engine department.
- The specifications for fuel monitoring/recording system and guidelines for fuel consumption data entry and reporting for consistent application fleetwide.
- A real-time (or post-voyage) feedback tool to measure the ship's force to monitor the impact of operating decisions on fuel consumption.
- Flexible shore-based monitoring, evaluation and reporting tools.

When developing the recording system and process, the following 'leaks' from the fuel system should be accounted for inaccuracies or inconsistencies of the sounding tables and/or level/density measuring system; the amount of waste produced by auto-backflush filters; the impact of water added at the purifier to make sludge; the amount of leakage in the fuel oil

system between HFO/MDO and overflow/waste oil during normal operation and fuel switching; the amount of water kicked out of the settlers/service tanks daily; and the impact of incinerators on sludge discharge.

While precise information on wind and sea state are important for voyage planning (including the consideration of optimum fuel consumption routing), it is not critical for the fuel consumption measuring system if precise measurement of small changes in resistance due to energy-savings measures (including new paint, hull cleaning, etc.) is done with careful measurements taken during short duration runs in calm water (and in opposite directions if current and drift are unknown).

Overall Energy Efficiency Management

There are a significant number of energy efficiency measures that can and should be considered by the shipowner/operator in order to minimize fuel consumption, fuel cost and emission footprint. In order to carefully coordinate the efforts made to improve efficiency it is suggested that a well-managed process be undertaken, such as that defined in the Ship Energy Efficiency Management Plan (SEEMP) regulations. It is also useful and necessary to incorporate into this plan a well-designed ship performance monitoring process.

Ship Performance Monitoring

True ship performance monitoring includes data collection, analysis, reporting and dissemination to the relevant stakeholders. This will provide those with decision-making authority the information they need to understand current fuel efficiency performance and to make improvements. This data analysis and reporting should be done for each ship as well as for each class of vessels owned and the entire fleet. The fleetwide analysis provides useful comparative performance indicators and will give the owner/operator the data necessary to determine if the ships have been deployed in the most efficient manner.

The data collection is not just about fuel consumption figures. Data collection should also include voyage information, machinery operating parameters, hull and propeller inspection reports, and maintenance and cleaning events. By linking

issues from machinery, propulsion (resistance and operational decisions), and even ship design it is possible to get a holistic view of energy efficiency and the fully integrated nature of the energy consumption puzzle.

There are many vendors providing tools to help with ship and fleet performance monitoring, data analysis and reporting. Usually these are focused more on monitoring for hull and propeller efficiencies and other voyage optimization measures, but the more comprehensive tools do incorporate data collection and analysis on the engine and machinery performance as well. The owner does not have to get an all-in-one provider, but he should address all the key factors for performance monitoring.

In addition, before committing to one or more vendors, the owner should be clear on the following elements of a performance-monitoring process:

- The data that should be recorded including how it is measured and the frequency intervals.
- How the data is collected, stored, analyzed and reported should be specified.
- Based on the knowledge gained from the collected data, actions should be determined as well as stakeholders identified as responsible parties to carry out those actions.

Ship Energy Efficiency Management Plan (SEEMP)

IMO requirements, industry initiatives, fuel prices and corporate responsibility are driving owners/operators to implement a Ship Energy Efficiency Management Plan (SEEMP). In July 2011, IMO adopted an amendment to MARPOL Annex VI that makes a SEEMP mandatory for all new and existing ships as of 1 January 2013. (For existing vessels, the SEEMP is to be on board at the first intermediate survey or engine certificate renewal date after 1 January 2013, whichever comes first.) The scope and detail of the SEEMP can vary and there are several guidelines already published for owners and operators to reference.

It is also understood “that the best package of measures for a ship to improve efficiency differs to a great extent depending upon ship type, cargoes, routes and other factors,…” (MEPC.1/683). So, no one-size-fits-all SEEMP exists, even if the overall framework and process are the same.

Figure 62 displays the four main steps for SEEMP implementation:

- Planning
- Implementation
- Monitoring
- Self-evaluation and improvement

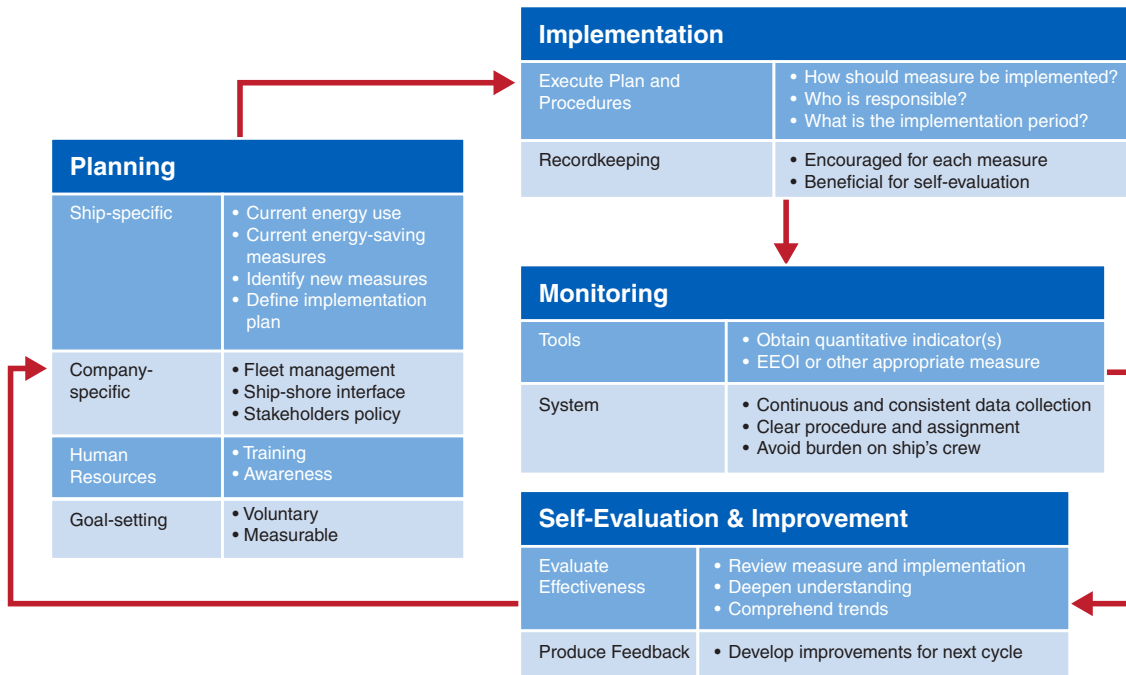

Figure 62. Four-step Continuous Improvement Process

Planning

The core functions of the planning phase (and most time consuming) are the assessment of current vessel and fleet energy efficiency and the evaluation/selection of new measures to implement. These can be done to varying levels of detail depending on the goals of the owner. The goal setting and drafting of the plan document are less time intensive.

Specific planning tasks include:

- A fleet and ship energy use assessment
- Setting of ship, fleet and corporate energy efficiency goals
- Evaluation and selection of energy-saving measures
- Planning the changes to processes and equipment necessary for ships and fleet
- Identifying and developing tools for monitoring and measuring performance
- Drafting the full SEEMP

The actual management plan is to include the following elements:

- Definition of corporate and ship-specific goals
- Description of efficiency measures and how they will be implemented
- Explanation of how 'buy-in' by various stake holders will be achieved
- Definition of metrics to be used to evaluate performance
- Description of a monitoring plan
- Description of how performance is analyzed
- Outline of steps for identifying and implementing energy efficiency improvements

Implementation

This phase requires concrete plans for making the necessary changes to the vessels, their operations and management. Included are the assignment of responsibilities for each element of the SEEMP, engineering design development and training.

Implementing the SEEMP should include the following elements:

- Publish the SEEMP
- Make changes to processes and systems
- Assign responsibilities
- Provide training to the crew and shoreside staff

A key part of the implementation and training is to increase energy efficiency awareness throughout the organization. Personnel at all levels should be aware of the efficiency goals and participate in the process of continual improvement. This is especially critical for the shipboard crew responsible for day-to-day operation of the ship and its machinery.

Monitoring

Monitoring means continuous collection of pertinent data. The plan for monitoring is established in the planning phase. The monitoring phase covers efforts during operations and for the life of the vessel. It should be a combination of automated data recording and manual documentation that minimizes time for shipboard personnel. The company should implement a monitoring system and process with well-documented procedures that include reporting and data analysis.

Self-evaluation and Improvement

As specified in the SEEMP this evaluation should occur on a regular basis within a clear framework. It should include the following actions:

- An analysis of vessel and fleetwide monitoring data and a review of performance against established metrics and the plan.
- Identification of the cause and effect for observed performance and recommendations for changes and improvements for better performance.
- A review of the effectiveness of the SEEMP and recommendations for improvements to the SEEMP based on the review.
- Implement changes and continue monitoring.

References

1. Townsin, R.L. et. al., "Estimating the Influence of Weather on Ship Performance," RINA Transactions, Volume 135, 1993.
2. Holtrop, J., Mennen, G.G.J., "An Approximate Power Prediction Method," International Shipbuilding Progress, 1982, Vol. 29, pp. 166-170.
3. Hamburg Ship Model Basin (HSVA) Newsletter 2009/2.
4. L. Larsson et. al., 2010, "The Principles of Naval Architecture Series: Ship Resistance and Flow," pp. 196-201.
5. J. O. de Kat et. al., 2009: "An Integrated Approach toward Cost-effective Operation of Ships with Reduced GHG Emissions," 2009 SNAME Annual Meeting Proceedings.
6. SSPA Newsletter 46/2009: "Green Hydrodynamic Design."
7. Matsumoto et. al., "Reduction of Wind Forces Acting on Ships," J. Kansai Society of Naval Architects, Japan, 2003, No. 240, pp. 115-121.
8. Maruo, H., "The Excess Resistance of a Ship in Rough Sea," International Shipbuilding Progress, 1957, Vol. 4, pp. 337-345.
9. Hosoda, R., "The Added Resistance of Ships in Regular Oblique Waves," Japanese Society of Naval Architects, 1973, Volume 133.
10. Isherwood, R.M., "Wind Resistance of Merchant Ships," Transactions of Royal Institution of Naval Architects, 1973, Vol. 115, pp. 327-338.
11. Blendermann, W., "Wind Loading on Ships – Collected Data from Wind Tunnel Tests in Uniform Wind," Institut für Schiffbau der Universität Hamburg, 1996, Report 574.
12. OCIMF, 1994: Prediction of Wind and Current Loads on VLCCs, Second Edition.
13. IMO MEPC 62/64/Add.1 Annex 19, Resolution MEPC.203(2), adopted on 15 July 2011.
14. Ozaki, Y. et. al., 2010: "An Evaluation of the Energy Efficiency Design Index (EEDI) Baseline for Tankers, Containerships and LNG Carriers," Climate Change and Ships: Increasing Energy Efficiency, SNAME and Marine Board Symposium.
15. ISO 15016, "Ships and Marine Technology – Guidelines for the Assessment of Speed and Power Performance by Analysis of Speed Trial Data," First Edition 2006-05-15.
16. Grothues-Spork, H., "Bilge Vortex Control Devices and Their Benefits for Propulsion," International Shipbuilding Progress, 35, 1988.
17. J. S. Carlton, "Marine Propellers and Propulsion," Second Edition, BH, 2007.
18. HSVA, "Successful Development and Validation of the Becker Mewis Duct," Newswave 2011/1.
19. CMA-CGM Press Information.
20. HSVA, "The Hamburg Ship Model Basin Targets Energy Efficiency of Ships," Newswave 2010/2.
21. U. Hollenbach, O. Reinholz, "Hydrodynamic Trends in Performance Optimization," 11th International Symposium on Practical Design of Ships and Other Floating Structures, Rio de Janeiro, 2010.
22. HSVA, "Optimising Container Ship Hull Forms for Real-Life Operation Profiles," Newswave 2009/2.
23. The Royal Institution of Naval Architects, *Naval Architect*, April 2011.
24. P. Naaijen, V. Koster and R.P. Dallinga, "On the Power Savings by an Auxiliary Kite Propulsion System," International Shipbuilding Progress, 2006.
25. Fathom, *Ship Efficiency: The Guide*, 2011.
26. J. Larkin et. al., "Influence of Design Parameters on the Energy Efficiency Design Index (EEDI)," SNAME Symposium on Climate Change and Ships, February 2010.
27. Marginal Abatement Costs and Cost-Effectiveness of Energy-Efficiency Measures, IMO MEPC 61/INF.18, 23 July 2010.
28. R.A. Hartley, International Paint Co., "Hull Roughness, Antifouling Coatings and Ship Performance," SNAME Shipboard Energy Conservation meeting, 21-22 September 1980.
29. M. Candries, PhD Thesis, "Drag, Boundary-Layer and Roughness Characteristics of Marine Surfaces Coated with Antifouling," University of Newcastle-Upon-Tyne, December 2001.
30. M.P. Shultz, "Economic Impact of Biofouling on Naval Surface Ships," December 2010.
31. M. Atlar et. al., "The Effect of a Foul Release Coating on Propeller Performance," University of Newcastle-Upon-Tyne and International Coatings Ltd., Proc. of ENSUS, 2002.



WORLD HEADQUARTERS

ABS Plaza • 16855 Northchase Drive • Houston, TX 77060 USA
Tel: 1-281-877-5800 • Fax: 1-281-877-5803
Email: ABS-WorldHQ@eagle.org

AMERICAS DIVISION

ABS Plaza • 16855 Northchase Drive • Houston, TX 77060 USA
Tel: 1-281-877-6000 • Fax: 1-281-877-6001
Email: ABS-Amer@eagle.org

EUROPE DIVISION

ABS House • No. 1 Frying Pan Alley • London E1 7HR, UK
Tel: 44-20-7247-3255 • Fax: 44-20-7377-2453
Email: ABS-Eur@eagle.org

GREATER CHINA DIVISION

5th Floor, Silver Tower • No. 85 Taoyuan Road
Huang Pu District • Shanghai, 200021 P. R. China
Tel: 86-21-2327-0888 • Fax: 86-21-6360-5391
Email: ABSGreaterChina@eagle.org

PACIFIC DIVISION

438 Alexandra Road #10-00 • Alexandra Point • Singapore 119958
Tel: 65-6276-8700 • Fax: 65-6276-8711
Email: ABS-Pac@eagle.org

NAUTICAL SYSTEMS DIVISION

ABS Plaza • 16855 Northchase Drive • Houston, TX 77060 USA
Tel: 1-281-877-5700 • Fax: 1-281-877-5701
Email: NS-info@eagle.org

www.eagle.org