

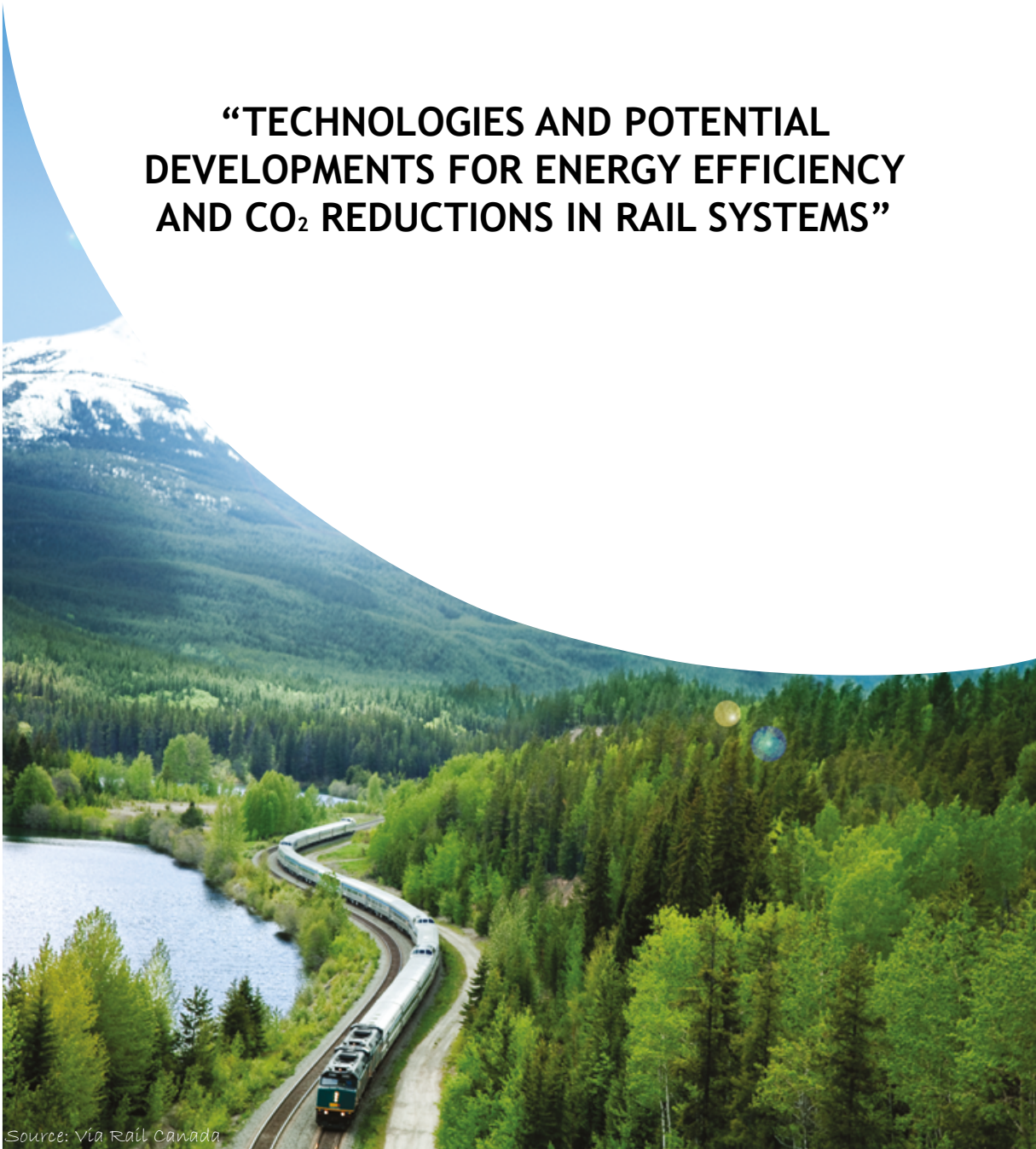

“TECHNOLOGIES AND POTENTIAL DEVELOPMENTS FOR ENERGY EFFICIENCY AND CO₂ REDUCTIONS IN RAIL SYSTEMS”



Source: Via Rail Canada

Warning

No part of this publication may be copied, reproduced or distributed by any means whatsoever, including electronic, except for private and individual use, without the express permission of the International Union of Railways (UIC). The same applies for translation, adaptation or transformation, arrangement or reproduction by any method or procedure whatsoever. The sole exceptions - nothing the author's name and the source - are "analyses and brief quotations justified by the critical, argumentative, educational, scientific or informative nature of the publication into which they are incorporated" (Articles L 122-4 and L122-5 of the French Intellectual Property Code).

© International Union of Railways (UIC) - Paris, December 2016.

Acknowledgment

This publication has been commissioned by the International Railways Union (UIC) and produced by the Spanish Railways Foundation (FFE), coordinated by Ignacio González Franco and Eva Suárez Marcos under the supervision of Alberto García Álvarez, for the FFE, and by Gabriel Castañares Hernandez for UIC.

A special mention goes to the cooperation of Pablo Salvador, Carla García and Pablo Martínez (UPV) for the completion of this work and to the contributions from UIC Energy Efficiency and CO₂ Experts Network members improving the data collection and the document.

Gratitude is also extended to Eduardo Prieto, Luis E. Mesa, Gonzalo Rubio, Eduardo Pilo and Amador Robles for their collaboration.

Index

0.	Introduction	6
0.0.	Executive summary	7
0.1.	Introduction	9
0.2.	Energy uses in the railway system	10
0.3.	Objectives	13
0.4.	Measures classification	14
0.5.	Methodology	18
0.6.	Glossary	20
1.	Infrastructures, trains and installations design	21
1.1.	Infrastructure design	22
1.1.1.	Railway layout	23
1.2.	Rolling stock design and new materials	27
1.2.1.	Architecture of trains.....	28
1.2.2.	New materials	34
1.2.3.	Life cycle and recycling	39
1.2.4.	Mechatronics	43
1.3.	Non-Traction Loads	47
1.3.1.	Renewable sources in non-traction loads	48
2.	Measurements related to power traction	52
2.1.	“Well-to-tank” losses	53
2.1.1.	Generation and distribution	54
2.1.2.	Electrification	58
2.2.	“Tank-to-wheel” losses	63
2.2.1.	Traction	64
2.2.2.	Hybrid trains	68
2.2.3.	Hydrogen fuel cells	72
2.2.4.	Natural gas propulsion	76
2.3.	Other measures	80
2.3.1.	Regenerative brake	81
2.3.2.	Reversible substation	86
2.3.3.	Neutral zones	92
3.	Measurements related to ancillary systems	96
3.1.	Ancillary systems on board	97
3.1.1.	On board HVAC	98
3.1.2.	Train lighting system	102
3.2.	Depots and stations	106
3.2.1.	HVAC in railway stations	107
3.2.2.	Lighting system	112
3.2.3.	Escalators	117
3.3.	Infrastructure ancillary systems	121
3.3.1.	Heating points	122

4.	Energy management	126
4.1.	Eco-driving	127
4.1.1.	Driving strategies	128
4.1.2.	Driving Advisory Systems (DAS)	134
4.2.	Energy storage systems	140
4.2.1.	Flywheels	141
4.2.2.	Supercapacitors	146
4.2.3.	Batteries	152
4.3.	Train operation	157
4.3.1.	Timetable compatibility	158
4.3.2.	Railway Smart Grids	162
4.3.3.	Connected - DAS	168
4.3.4.	Load factor	172
4.3.5.	Metering devices	177
5.	Conclusions	181
5.1.	Measures	182
5.2.	Reflections on the future	185
5.3.	Bibliography	187

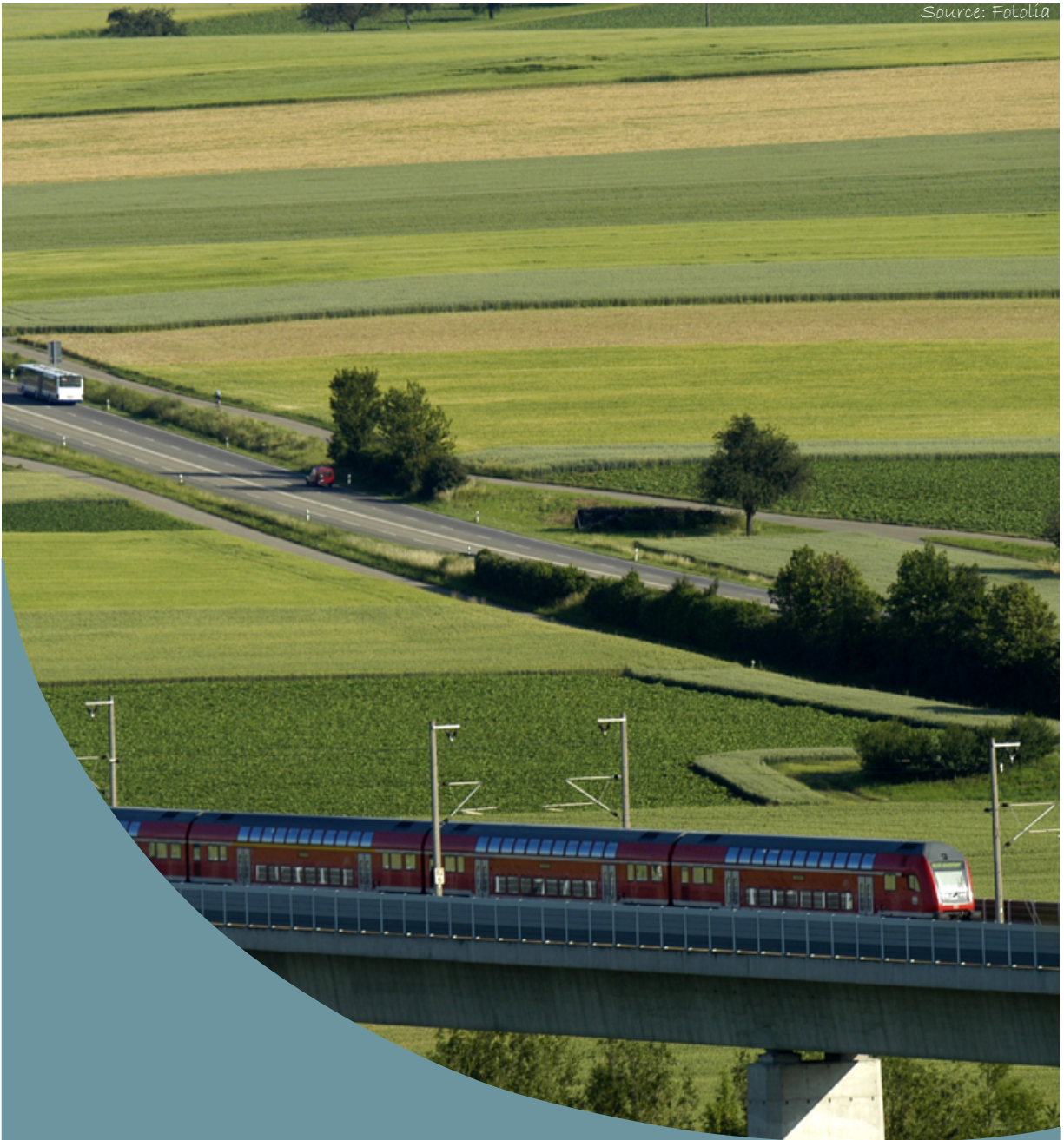

0. Introduction

0.0 Executive summary

The collection and analysis of all these technical and/or technological breakthroughs is the key to understand what is the point where railway stand and which is its potential for the future. In order to deal with it, this study aims to describe the most recently and current researches about the potential reductions of energy consumption and CO₂ emissions, according to the technologies developed nowadays, as well as the study aims to analyse the good practices carried out by railway undertakings that encouraged energy efficiency.

This study is materialized in three chapters:

- Chapter **Introduction**. This chapter summarised the measures analysed and the need to carry out efficiency studies.
- Chapter **“Measures analysed”**. In this chapter, for each of the technologies analysed, the methodologies applied will be described, as well as the estimation tools used, and it also will include the potential savings that can be achieved by the use of each technology.
- Chapter **Conclusions**. This third chapter will analyse and summarize all those technologies and innovations studied that have the highest energy efficiency effects on the railway sector and, therefore, those that will have a higher impact in the future. Furthermore, it will be include here a final section with some reflections on the future significance of the energy efficiency in the railway sector.

0.0.1. The new paradigm

The improvement of energy efficiency is one of the main objectives of railway companies. The reason for this is that, an increase in energy efficiency leads to a reduction of financial costs, as well as contributing to improve the environmental behaviour and, consequently, contributing to enhance the economic and social benefit in the cost-benefit analysis, which justifies the public politics in terms of modal shift from other modes to railway.

The achievement of this goal has been traditionally supported on the reduction of the amount of the energy consumed, but recently the objectives have been adjusted. The reason for this is that the amount of energy by itself does not appropriately reflect the financial and economic social costs of energy usage. Indeed, on the one hand, the environmental effects largely depend on the kind of energy used (it is not the same for diesel trains than for electric trains, and within the latest, it depends on the electricity mix). But on the other hand, the cost is increasingly modulated by the time in which the energy is consumed (and even the site where it is consumed) and additionally there is the possibility of reducing the total amount of the energy consumed, returning to the power grid, part of the energy regenerated in the braking.

$$Cost_{energy} = Min \left(\sum_i E_{Cons_i} \times P_{Cons_i} - \sum_i E_{Reg_i} \times P_{Reg_i} \right)$$

Where: $Cost_{energy}$: Total cost of the energy; i : period of time; E_{Cons_i} : Energy consumed in each period of time i ; E_{Reg_i} : Energy consumed in each period of time i ; P_{Cons_i} : Price of the energy consumed in each period of time; P_{Reg_i} : Price of the energy regenerated and returned to the grid in each period of time.

To make this issue more complicated, in many cases, the price to be paid by the railway for the energy consumed or also the price paid to the railway operator for the energy returned to the power grid do not reflect adequately the actual social costs of the use of the energy. Thereby, the price does not send the right signals to improve energy efficiency. Furthermore, in some cases, as in the case of the treatment of emissions rights for electric traction, the railway is discriminated, sending reverse signals to those that would get the optimum from the system.

$$P_{Cons_i} = f(\text{social cost})$$

$$P_{Reg_i} = f(\text{social cost})$$

Finally, it is important to highlight that the railway is a part of the transport system, and it would be desirable that it could contribute to improve the energy efficiency and environmental behaviour of the system as a whole. Thus, for example, an increase in train speed could raise specific energy consumption; however, this could increase the attractiveness of the railway mode, obtaining passengers of transport modes with lower efficiency. The same could happen if other parameters are improved, as frequency, comfort, etc.

In order to deal with this problem in a more balanced manner and with a future vision, the classical paradigm that consists of optimizing the system by reducing the amount of energy imported needs to be replaced by a new methodology that considers the net cost of the energy (equilibrating the imported and the exported), taking into account that, in a more evolved system, the price of the energy will reflect the social costs of its usage.

Therefore, it is not only essential to reduce the energy consumption of trains and ancillary systems (both the infrastructure ancillary and the auxiliary systems of trains), but also it is crucial to deploy a set of measures, whether operational or related to the smart management of the energy, that allow achieving the great challenges, related to the energy efficiency, that the transport sector must face.

0.1. Introduction

Mobility growth forecasts and its consequences or negative effects in terms of energy, are two of the great challenges that society has to face today. The transport model, as it is known nowadays, is without a doubt, unsustainable. Any increase in mobility infers serious pollution problems as well as involving increases in energy demand which, along with the lack of natural resources, project a discouraging image of the future.

In the last two decades, great efforts have been made and continue to be made, not only in technology, but also in the regulatory sense in order to minimize the negative effects of transport and achieve a sustainable development.

It is socially accepted that railway is more energy efficient and environmentally friendly than other competing transport modes. And this, both regarding primary energy consumption (especially that primary energy that comes from non-renewable sources) as well as in GHG emissions. Besides, the gas emissions at local level are lower, both in quantity as well as in the relocation of the greenhouse emissions. And in fact, this belief corresponds to reality in most cases.

More recently, it has been demonstrated that high speed rail is not only more energy efficient and environmentally friendly than other competing transport modes, but also it is more efficient than the conventional train which it normally replaces. Furthermore, the higher the speed, the higher the capacity of passenger attractiveness from other transport modes which are less efficient (especially plane and car), thus, the increasing of train speed also contributes to the increase of the efficiency of the transport system.

Despite the difficulties of homogeneous and fair, figures show that railway, especially with electric traction, obtains important advantages for society when passengers and goods from other modes are attracted, particularly by reducing GHG emissions. Neither this reality extends to all cases nor is the railway intrinsically superior. This means that, it is not true, as it is asserted usually, that the main reason for the lower energy consumption and emissions compare to car mode, are due to the lower friction between wheel and rail compared to the friction between rubber and road. Even though effectively, this friction is lower, the weight per seat of trains is disproportionately higher than other transport modes, and this makes it almost irrelevant the difference regarding friction resistance.

The truth is that the leading position of the train has not been a stimulus to improve energy efficiency, in general, this has remained substantially stable over the last 20 years. Some technological improvements have been offset by the increased consumption of auxiliary in passenger services. Meanwhile, in other modes of transport where the cost of energy is a very important part of the total costs significant efforts have been made to improve efficiency, so that the advantage of the train has been reduced in latest period.

The possibility to continue losing its advantages (which are those that justify the investments in rail) is more evident as the demands of reducing GHG emissions agreed in the recent UN Paris summit will force that, in a not a very long term, virtually all cars will be electric (like in Norway where fossil fuel propulsion cars have been forbidden from 2025), and power generation will be free of emissions of greenhouse gases. Then the railroad will have lost a part of its competitive advantages.

0.2. Energy uses in railway system

The energy used in the railway systems is divided into two different blocks as it is shown in the figure include bellow:

- The construction consumptions, which are produced just once.
- The operation consumptions that happen in a recurrent mode. This one is divided into “train consumption” and “other uses other than traction” (ancillary services).

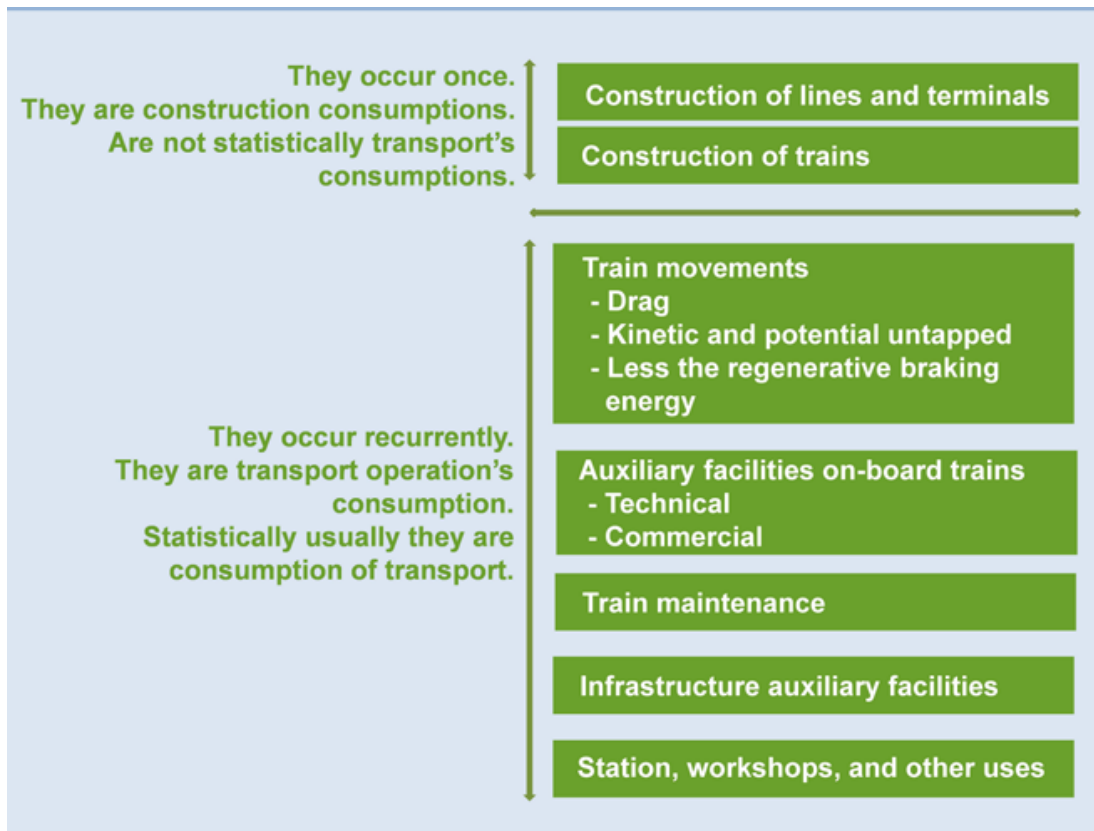

Figure 6. Energy uses. Source: García, A. (2016).

0.2.1. Description of the energy uses

Energy consumption in railway operation, is characterized (unlike the construction) by being recurrent or repetitive. This consumption is produced in four areas or type of activities:

- Energy for the movement of trains. This part of energy consumption is the most important quantitatively and the most characteristic of rail transport.
- Energy for auxiliary systems of the trains. The technical auxiliary systems in the vehicles are necessary for the correct operation of the vehicles (fan engines, compressors, etc.); and the commercial auxiliary systems are necessary for the comfort of the passengers or the conservation of the load (heating systems, cooling systems, lighting, etc.). In the past, these services were reduced but the increase of the comfort requirements on board trains has made this consumption relevant.
- Energy for auxiliary systems of the infrastructure, that include, for example, lighting consumption of tunnels or sections of track, point heating systems, the signalling and communication systems, etc.
- Energy for stations, workshops and other uses. In this section the energy consumption for lighting and air conditioning parking lots, stations, terminals, freight marshalling yard, workshops and offices are included. These consumptions have not a large relative weight (at least in intercity rail systems).

The movement of trains and the auxiliary services require an important contribution of energy. However, there are other energy uses within the railway sector.

- For the construction of infrastructures and buildings. In this case, lines, stations and workshops. In this section, the necessary energy for the earthmoving works, tunnelling, transport to landfill, etc., can be also mentioned.
- For the construction of the trains, including the extraction of raw materials, the manufacturing processes and the transport of pieces and components, for assembly the train, etc.

Figure 8 shows the energy flows for the Spanish case in 2011.

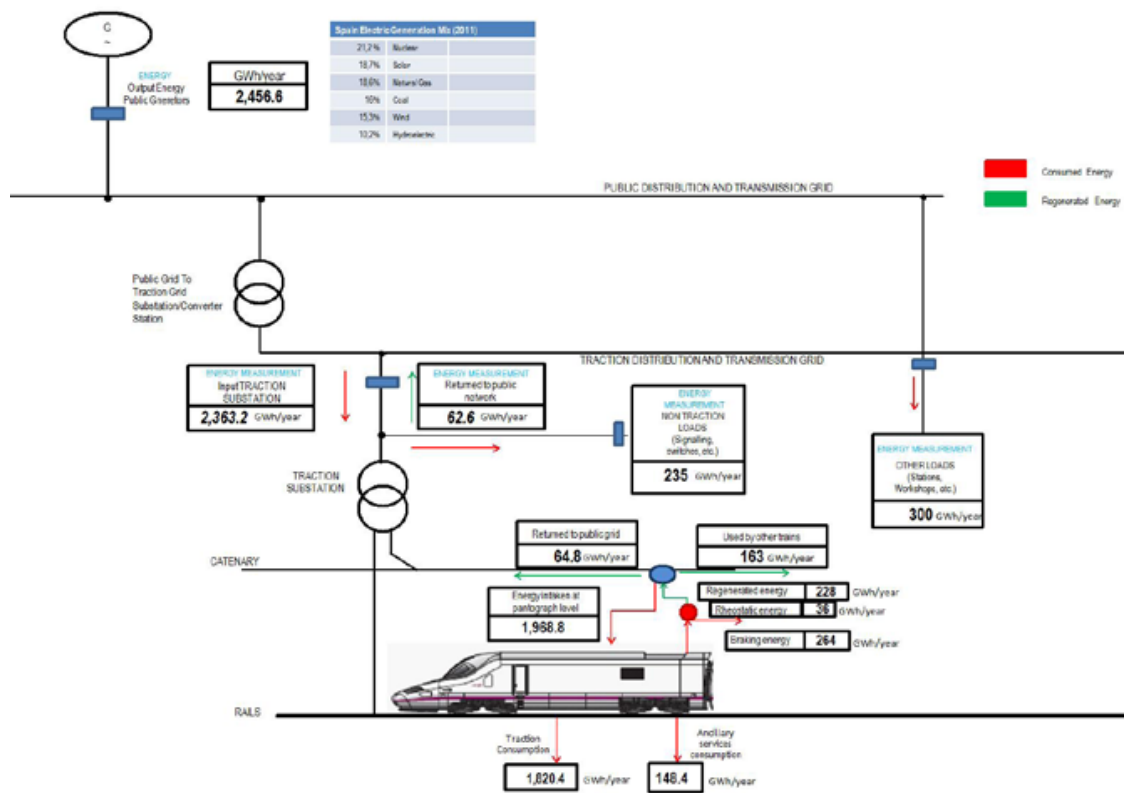

Figure 8. Energy flows for the Spanish case in 2011. Source: Merlin project.

0.3. Objectives

The improvement of energy efficiency is one of the main objectives of railway companies. The reason for this is that, an increase in energy efficiency leads to a reduction of financial costs, as well as, contributing to improve the environmental and, consequently, contributing to enhance the economic and social benefit in the cost-benefit analysis, which justifies the public politics in terms of modal shift from other modes to the railway.

The achievement of this goal has been traditionally supported on the reduction of the amount of the energy consumed, but recently the objectives have been adjusted. The reason for this is that an amount of energy by itself does not reflect appropriately the financial and economic social costs of energy usage. Indeed, on the one hand, the environmental effects largely depend on the kind of energy used (it is not the same for diesel trains than for electric trains, and within the latest, it depends on the electricity mix). On the other hand, the cost is increasingly modulated by the time in which the energy is consumed (and even the site where it is consumed), and in addition there is the possibility of reducing the total amount of the energy consumed, returning, to the power grid, part of the energy regenerated in the braking.

To make this issue more complicated, in many cases, the price to be paid by the railway for the energy consumed or also the price paid to the railway operator for returning energy to the power grid do not reflect adequately the actual social costs of the use of the energy, thereby, the price does not send the right signals to improve the efficiency. Furthermore, in some cases, as in the case of the treatment of emissions rights for electric traction, the railway is discriminated, sending reverse signals to those that would get the optimum of the system. Finally, it is important to highlight that the railway is part of the transport system, and it would be desirable that it could contribute to improve the energy efficiency and environmental behaviour of the system as a whole. Thus, for example, an increase in train speed could raise specific energy consumption; however, this could increase the attractiveness of the railway mode, obtaining passengers of transport modes with lower efficiency. The same could happen if other parameters are improved, as frequency, comfort, etc.

In order to deal with this problem in a more balanced manner and with a future vision, the classical paradigm that consists of optimizing the system reducing the amount of energy imported needs to be replaced by a new methodology that considers the net cost of the energy (equilibrating the imported and the exported), taking into account that, in a more evolved system, the price of the energy will reflect the social costs of its usage.

It is not only essential to reduce the energy consumption of trains and ancillary (both the infrastructure ancillary and the auxiliary systems of trains), but also it is crucial to deploy a set of measures, whether operational or related to the smart management of the energy that allows achieving the great challenges, related to the energy efficiency, that the transport sector must face.

Therefore, this study aims to review some of the most important developments that are currently carried out or those that, in a short, mid-term will be addressed, as well as analyse those research projects which aim the energy efficiency in the railway sector. The idea is to highlight the current situation of the railway sector, as well as the future situation in terms of energy efficiency.

Also the work and approach of the document has been designed to serve as a “toolbox” for the railway companies in order to aid the planning of their energy efficiency strategy. Companies will have the complete range of energy efficiency measures that can be applied to railways and, thus, can choose the best mix for their energy efficiency strategy according to their particular situation and their technical, social, economic and environmental objectives.

0.4. Measures classification

Reducing demand and emissions of the rail system is a long sought goal. Initially it was for economic reasons; then also the risk of shortages in successive oil crises came into play; and most recently the fight against climate change undertaken by the whole international community.

The objective of reducing consumption and emissions has been addressed and approached from very different perspectives that could be classified according to several criteria. It is a complex task to try to make a single and extrapolate classification for all the existing cases, basically because, as it has already been underlined, the variety of existing measures and technologies.

The choice of applying one measure or another depends much on the specific case and the starting phase where the system is, even the urgency and priority will depend on the baseline. A clear example of this case is reversible substations: It is a priority to install reversible substations in those networks where trains have regenerative braking and even at those points in the network where there is heavy traffic with lots of intermediate stops. In any other scenario it may not be convenient to install reversible substations.

Also, this choice depends on the economic possibilities, that is, if you have enough budget to implement it or not. A specific measure may be very good in terms of efficiency but the cost may not be acceptable.

In order to assess the effect of the different measures analysed and to help the different agents constituting the rail system, it seems appropriate to establish different classifications to help position each particular case.

Therefore three new classifications are proposed that depend on:

- The life cycle phase.
- The railway subsystem in which they are applied.
- The conceptual level.

The different classifications are listed below.

0.4.1. Classification of measures according to life cycle phase

Energy efficiency in rail transport can be reached: either with a suitable design or with an execution of operations aimed at reaching certain energy efficiency objectives; and usually with a combination of both measures.

Design decisions (whether infrastructure, vehicles or operating systems) should be taken in advance (sometimes well in advance), and once these decisions have been taken they are often difficult to change. But still other measures can be applied in the operation phase to produce a reduction in consumption.

The measures taken in the design phase usually have a greater effect than those adopted in subsequent phases.

Therefore, according to the time of the life cycle of rail service that measures are taken, they can be classified as follows:

1. Measures that are taken in the design phase of lines or trains, prior to deployment of services.
2. Measures of redesign, already adopted with lines and trains in operation and which are specified in modifications made to each one (both lines and trains).
3. Operational measures on processes which are adopted in the exploitation phase of the service. This section provides regulatory or fiscal measures that will lead to the desired results without resorting to a specific investment in materials may also be included.

0.4.2. Measures classification according to the subsystem where are applied

According to the specific railway subsystem the measures can be distinguish as it follows:

1. Measures related to the line layout (ramps, curves, detours, etc.) and its gauge.
2. Measures related to the electrical infrastructure (substations, catenary, network topology, voltage electrification, conductive sections, etc.).
3. Measures related to the rolling stock (train size, mass, architecture, engine, etc.).
4. Measures related to the operation of trains (timetables, stops, traffic control, driving techniques, etc.).
5. Measures related to other areas of the rail system (stations, workshops, factories, etc.).
6. Measures related to the connection to the public electricity system (return to the network, interruptibility, etc.).

0.4.3. Classification according to the conceptual level

Another classification can be defined, according to the conceptual similarity of each field:

0. “Zero Scope” measures, which would be those that apply to the railway system as well as to any other sector. These include actions affecting buildings, stations, workshops, etc.(activities that are not essentially different from other sectors). For example, the use of energy saving light bulbs, automatic shutdown of lights, improved insulation of air conditioning, etc. Also, those related to the proper allocation of energy consumption for the user perceives “signs” that will stimulate savings are also included. In the case of rail, this allocation is uniquely complex.

1. First level, which includes measures related to trains and the layout that specifically affect rail and that pursue the reduction of the amount of energy needed for the movement and power the auxiliary services of trains. These include, for example, reduced mass, adopting a train efficient architecture, improved performance, etc. They are generally limited to the moment of the design of trains and track layout.

2. Second level of measures, which have to do with electric traction. These range from increasing the use of electric traction (with the extension of electrification of lines and promoting the use of electric trains on electrified lines) to other measures leading to reduce energy losses in power systems of the train.

3. The third level relates to the optimization of the operation, both in the design and implementation of efficient driving patterns (either manual or automatic); as the proper design of schedules, the efficient distribution of stops, an optimum traffic control, reducing empty train runs, etc.

4. The fourth level of measures relates to the management of the regenerative brake and onboard and ground energy accumulation devices. In both cases, the aim is to get the most energy regenerated in the brake considering the railway system as an isolated system that cannot return energy to the public grid, nor can store energy outside the train.

5. Fifth level of measures, include measures which no longer conceive the railway as a closed system, but include the possibility of interacting with electricity grids; the electric and rail system are equipped with some kind of “intelligence” and certain anticipation ability. In this sense, ground accumulation devices may be included in this level; the possibility of returning energy to the grid according to the state of generation; the ability to interrupt the supply entirely or to reduce power, and the interconnection of traction with non-traction rail networks (stations or workshops).

0.4.4. Measures for the reduction of energy consumption

After outlining the existing problems when defining a possible classification that encompasses all measures and analysed technologies, a scheme with the positioning of the studied measures in each of the possible areas of application is needed. The final classification is as follows (Table 1).

Field of Application	Field 0 Common measures to other sectors	Field 1 Measures of train and track design	Field 2 Efficient use of power traction	Field 3 Optimization of operations	Field 4 Use of the regenerated energy	Field 5 Interaction between electricity networks
Railway layout						
Architecture of trains						
New materials						
Life cycle and recycling						
Mechatronics						
Renewable sources in non-traction load						
Generation and distribution						
Electrification						
Traction						
Hybrid trains						
Hydrogen fuel cells						
Natural gas propulsion						
Regenerative brake						
Reversible substation						
Neutral zones						
HVAC on board						
Train lighting system						
HVAC						
Lighting system						
Escalators						
Heating points						
Driving strategies						
Driving Advisory System (DAS)						
Flywheels						
Supercapacitors						
Batteries						
Timetable compatibility						
Railway Smart Grids						
Connected-DAS						
Load factor						
Metering devices						

 Design Measures

 Redesign Measures

 Operation Measures

Table 1. Measures for energy consumption reduction and emissions in the railway classified by field of application. Source: Independently produced (2016).

0.5. Methodology

0.5.1. Document layout

The analysis of these measures and the technologies which reduce energy consumption and CO₂ emissions, which means that can increase the railway efficiency, will be developed by grouping them into four blocks in order to study and quantify all possible energy flows and their potential improvements.

So, this part has been structured in the sections below:

1. Measures related to the infrastructures, trains and installations design. The following measures have been considered:

- Design of the infrastructure and design of trains considering new train architectures that allow reducing drag resistance, for example.
- Introduction of new materials that allow decreasing, for example the total weight of the rolling stock, which will help to reduce the energy consumption.
- Use of the renewable sources to feed non traction loads, as workshops, stations, etc.

2. Measures related to power traction. Amongst them the following can be highlighted:

- Electrify those railway lines that are not electrified. It can bring to electric traction, gross tons that currently are transported by diesel traction.
- Losses reduction in the traction chain due to the deployment of new technologies.
- Inclusion of reversible substations in the power supply system, mainly in DC electrification lines, contributing so to a higher use of the energy returned to the grid by trains.
- Adding to the operator fleet new rolling stock which uses alternative fuels (as liquid gas or hydrogen fuel cells).

3. Measures related to ancillary systems. It should take into account the incorporation of new technologies that allow decreasing the energy consumption in both the ancillary systems on-board (as HVAC technologies or new lighting systems) and the ancillary system of the infrastructure.

4. Measures related to Energy Management. Amongst them the following can be underlined:

- Measures related to driving, by either the introduction of ECO-Driving Systems or due to the driver's knowledge of the existing differences of driving strategies, depending if the train has regenerative brake or not.
- Introducing, in the power network, Energy Storage Systems and to provide them with "intelligence" in order to manage the use of the energy.
- Introducing Smart Grid technologies that allow a greater controllability of the electric loads (trains, auxiliaries, etc.) in order to, for example, reduce power peaks in a specific area of the line.

All these technologies will be studied in an independent way, explaining their goals and defining and quantifying the benefits contributed to railroad system.

0.6. Glossary

The description of energy uses and flows in transport entails the definition of some scientifically correct, understandable and homogeneous terms, which will be valid for all energy processes and for all transport modes; as well as the units to be used and the equivalents amongst them.

- Final energy: In the transport case, it is defined final energy as the energy that enters the vehicle and is the result of subtracting the primary energy to the losses produced in the transformation processes, changes in the pattern and transport which occurs before it reaches the vehicle.
- Primary energy: It is the amount of energy contained in fuels and energy resources before going through any transformation process.
- Useful energy: It is used for transport purposes. The sum of the energy consumed for the vehicle movement (measured in tires, wheels, propellers or wings) and the energy consumed by the auxiliary services (measured at the input of these consumer devices).
- Energy source: Those environmental elements which can supply energy. Renewable energy sources can be resorted permanently because they are endless; for example water, sun or wind. Non-renewable sources are those that whose reserves are limited and, thus, their reserves decrease as they are consumed; for example oil, coal or natural gas.
- Transport mode: It is a system defined by the vehicle and its infrastructure, and has its own technological characteristics (which are different from the propulsion system). Pipeline transport doesn't require any vehicle but it is considered a transport mean.
- Main engine: It is the vehicle engine that receives the external energy and converts it into another different type of energy for the vehicle movement (or impulse of a liquid). If there are different engines in the same vehicle (for example on a train or on a boat with diesel-electric propulsion there are a diesel engine and electric traction engines) the main engine is the one that receives the external energy (diesel engine in this case).
- "Tank to wheel" losses (TTW): These losses are those produced from the vehicle supply to the wheels. (This losses represents the difference between final energy and useful energy).
- "Well to tank" losses (WTT): These losses are energy losses which are produced in the different transformation and transport processes since the primary energy sources (which is represented by the wheel well oil, "well") to the vehicle supply in its "tank" of fuel. "Well to tank losses" is the difference between "primary energy" and "final energy".
- Propulsion system: It is formed by the main engine, the transmission and all the elements which convert energy that the vehicle receives into useful energy for movement.
- Energy transformation: It is the process aiming is to change between types of energy or its characteristics.
- Transmission: They are all the elements in a transport vehicle (including engines which are different from the main one) that convert the energy from the main energy into useful energy for movement.
- Energy vector: It is the type of energy that can be used in final uses, for storage or energy transport. Energy vectors are types of energy that are used to supply energy to the main engine, because they are transported, stored sometimes and handled in an easier way than its original form. Some energy vector examples are electricity and hydrogen, which does not exist in free conditions in nature, but can be obtained through other forms of energy.

Source: TP Ferro Concesionaria



1. Infrastructures, trains and installation design

1.1. Infrastructure design

1.1.1. Railway layout

1.1.1. Railway layout

Introduction

Efficiency

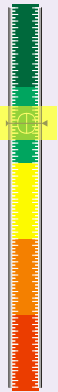

The implementation or design of an efficient line layout (i.e. homogeneous speed profile) reduces the use of the brake which means a reduction of losses and therefore an increase in system efficiency.

Investment

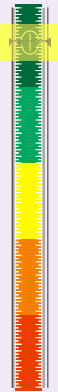

The investment cost of these set of measures is relatively low when the infrastructure is in a design phase (planning stage). However, the cost increases considerably if these measures are implemented once the line is built and in service.

Scope of the measure

- ➔ The energy dissipated by a high speed train (with homogeneous speed profile) may be a 58% lower than the energy dissipated by a conventional train.
- ➔ Avoid specific speed limits or sharp speed reductions can reduce the energy consumption.
- ➔ Adjusting the value of downward gradients with the train's maximum speeds can reduce energy consumption. The energy dissipated may be reduced a 73%.
- ➔ The existence of an upward gradient at the entrance of a station may imply less brake use and therefore less energy dissipated. Savings of 5.23% in tractive energy consumption and 23.62% in braking energy.

Field of application

	Field 0	Field 1	Field 2	Field 3	Field 4	Field 5
Field of Application	Common measures to other sectors	Measures of train and track design	Efficient use of power traction	Optimization of operations	Use of the regenerated energy	Interaction between electricity networks
Railway layout						
		Design Measures		Redesign Measures		Operation Measures

Technology Analysis

To achieve an efficient design of the railway layout, it is necessary to take into account the following measures:

1. Homogeneous speed profile. This is one of the most important measures to reduce energy consumption. A homogeneous speed profile may reduce the use of the brake and therefore reduce losses. Figure 1 shows several maximum speed profiles in different Spanish routes (high speed lines and conventional lines). The differences in energy consumption are big, for example the Alicante-Barcelona speed profile, in terms of energy consumption, has the same effect of having a stop every 17 km, otherwise, the Madrid-Barcelona profile has the same effect of having a stop every 550 km.

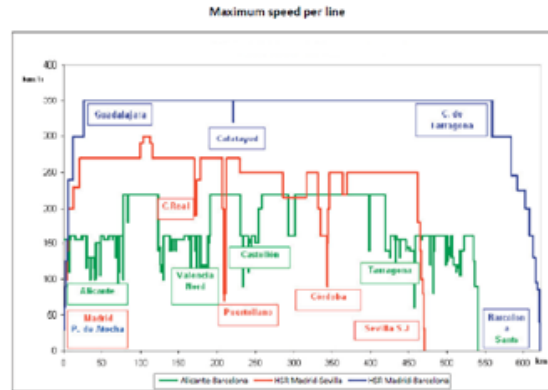

Figure 1. Maximum speed profile per route in several Spanish rail lines. Source: García, A. (2009).

2. Avoid punctual speed restrictions. Another measure of layout design that reduces consumption is to avoid specific relevant speed limits (lower than 50 km/h) or sharp speed reductions, which represent large losses of time, greater amount of energy dissipated in the brake and lower aerodynamic savings. The punctual speed restrictions have an important effect on the commercial speeds. If it is necessary to keep the timetable in a route, its effect on the energy consumption can be analysed in two different assumptions: (i) it is necessary to reduce the length of the line where coasting is performed and therefore energy consumption increase and (ii) it is necessary to increase the maximum speed in other line sections which means an increase of energy consumption.

3. Slopes adapted to speed. To reduce energy consumption it is appropriate to adjust the value of downward gradients with the train's maximum speeds allowed. If the actual gradient coincides with the gradient of repose¹, it is not necessary to accelerate or brake to maintain the speed, thus the energy consumption is reduced.

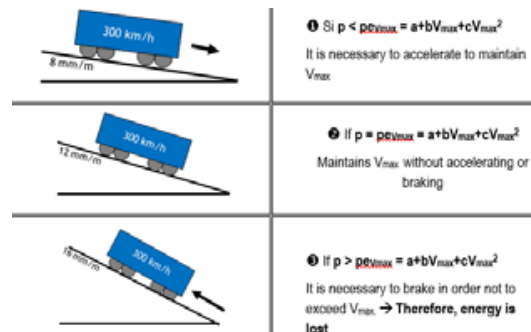

Figure 2a, 2b, 2c. Three possible cases for maintaining the maximum speed (300 km/h) on a downgrade. Source: González Franco, I. (2012).

4. Raise the station gradient. In sections where the train needs to reduce its speed, the existence of an upward gradient implies less brake use and therefore less energy dissipated. There are some energy advantages when the station is located on a higher point than its collateral sections. In this case, when the train approaches the station through an upward gradient it helps its deceleration and reduces the use of the brake. And when the train leaves the station a downward gradient reduces the power need. This configuration is particularly suitable for underground stations (see the study of Clemente Lázaro, I (2005)).



Figure 3. Metro line model (Noord/Zuidlijn Lijn line in Amsterdam). Source: García, A. (2009).

¹The gradient of repose for a certain speed (for example, the train's maximum speed) is the one which the force of gravity is equal to the resistance strength (rolling resistance) and the train is in repose and therefore maintains its running speed.

Objetives and benefits

The main objective is the energy reduction through the efficiency layout design. Trying to avoid the frequent accelerations and decelerations for rail transit trains, which adversely affect in the major performance of travel time, traction energy consumption and breaking wear.

1. Homogeneous speed profile.

A comparison between the energy consumption of a high speed train in a high speed line and a conventional train in a line with maximum speed of 200 km/h; both lines with the same length and number of intermediate stops, it has shown that the energy dissipated by the high speed train is a 58% lower than the energy dissipated by the conventional train (see Figure 4).

2. Avoid punctual speed restrictions.

In 1996 in the Madrid-Sevilla high speed line a 120 km/h speed restriction in a 12 mm/m slope implies of 2.5 minutes lost and an decrease of the energy consumption of 3%.

3. Slopes adapted to speed. In Madrid-Barcelona high speed line with maximum slopes of 25 mm/m, trains should use the brake in order to avoid exceeding maximum line speed. According to García Alvarez, A (2009), a high speed train running at 300 km/h of maximum speed dissipate in the brake 1,260 kWh (11% of the energy imported). The same train running at 350 km/h reduces the energy dissipated in the brake up to 392 kWh (approximately a 3% of the energy imported). A paradox occurs in this case, as it is not only the energy consumption is reduced but also the journey time.

4. Raise the station gradient. Table 1 listed, for different slopes and declarations, the energy saved in a station in which, 200 trains of 250 tons, stop each day in each direction. It is compared with the number of houses that consume the same energy per day, as well as CO₂ emissions generated by a car to produce the energy which is avoided (indicated in the number of km that a car needs to be driven to produce it).

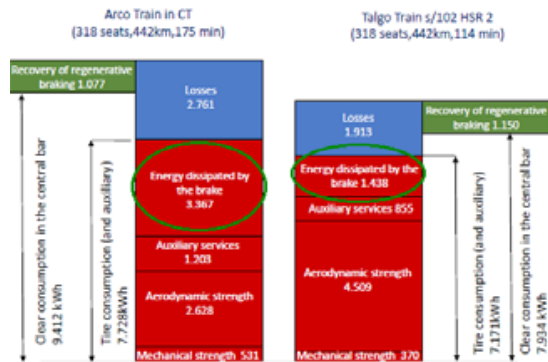

Figure 4: Comparison of the energy consumption disaggregated by a high speed train (right) and conventional train (left). Source: García Alvarez, A (2009).

Initial speed (km/h)	Final speed (km/h)	Saved energy (kWh)	No Regenerative Brake		Taking the 50% form the regenerative Brake	
			Nº of houses	Km to cover on a car	Nº of houses	Km to cover on a car
80	0	21.43	787	10,104	315	4,042
100	0	33.49	1,229	15,788	492	6,315
160	0	85.73	3,146	40,417	1,258	16,167
80	15	20.68	759	9,749	304	3,900
100	15	32.74	1,201	15,433	481	6,173
160	15	84.98	3,119	40,062	1,247	16,025

Table 1. Energy and emission saving by not placing a station on a higher elevation than collateral tracks. Source: García, A. (2009).

As it can be seen, for a Metro line in which a slope of 38 mm/m (corresponding to a deceleration of 0.4 m/s²) is designed and assuming an initial speed of 80 km/h and a final speed of 15 km/h, the energy saved in the station is the equivalent to the energy consumption per day of 759 homes or 304 homes considering regenerative brake. Moreover, CO₂ emissions that are avoided per day are equivalent to those produced by a car which drives 9,749 km and 3,900 km.

Applications

Theoretical applications

Author	Explanation	Benefits
Shu-Ta Yeh (2003)	The simulation is based on one-directional train movements on vertical track alignments between stations. The train movements were computed using relations of vehicle kinetics, resistances, tractive effort, power, propulsive, energy consumption, and braking energy consumption in different cases.	The study shows that using dipped vertical alignments it is possible to improve the travel time, tractive energy and braking energy. The maximum savings observed, for a case with 12,500 feet station spacing, are: 6.53% in travel time, 5.23% in tractive energy consumption and 23.62% in braking energy.

Real applications. Demonstrator

Author	Explanation	Benefits
García, A (2009)	In the Madrid-Barcelona high-speed line in 2007 the maximum speed on the stretch from Madrid to Camp de Tarragona changes from 280 km/h to 300 km/h.	It allowed an energy consumption reduction of about 3%, and moreover a simultaneous reduction in travel times was introduced.

Bibliography

- González Franco, I. (2012). Effect of increasing the maximum speed of high-speed trains on downgrades on energy consumption and journey time. UIC.
- Clemente Lázaro, I. (2005). “Reducción del consumo energético por elevación relativa en la cota de altura de la estaciones ferroviarias”. Proyecto de Fin del Master de Sistemas Ferroviarios ICAI curso 2003-2004.
- García, A. (2009). Energía y trazado ferroviario. Curso de diseño de ferrocarriles. CEDEX. Madrid, November de 2009.
- Shu-Ta Yeh (2003). Integrated analysis of vertical alignments and speed profiles for rail transit routes. Master of Science, University of Maryland. Maryland, (USA).
- Kim, M et al. (2013). Simulation-based rail transit optimization model. Master of Science, University of Maryland. Maryland, (USA).

1.2. Rolling stock design and new materials

- 1.2.1. Architecture of trains
- 1.2.2. New Materials
- 1.2.3. Life cycle and recycling
- 1.2.4. Mechatronics

1.2.1. Architecture of trains

Introduction

Efficiency

Air resistance and friction produce energy losses. Acting on them offers a great opportunity to improve energy efficiency. In this way, vehicle aerodynamic design has a critical impact on energy efficiency, through reducing wind resistance of the vehicle's exterior and reducing losses associated with requirements for the cooling flow through the engine compartment.

Investment

Although the necessary studies and modelling computer approaches to establish an optimized train shaping are expensive, vehicle aerodynamic designs will be used increasingly in the future due to their higher energy efficiency.

Scope of the measure

- ➔ An improvement of energy efficiency: an aerodynamic drag reduction of 25% and up to 15% less traction energy usage.
- ➔ An increase of cross-wind stability at high speed thanks to a reduction of the wind force on the head car: a decrease of the wind force on the lead car equivalent to 5-7 tons of additional ballast and a potential weight savings whilst maintaining the same cross-wind performance.
- ➔ A reduction of journey times due to higher acceleration capabilities.
- ➔ An optimized train shaping reduces the aerodynamic drag, hence reducing the energy consumption.
- ➔ A more efficient train reduces the total amount of energy used and the emissions of CO₂.

Field of application

	Field 0	Field 1	Field 2	Field 3	Field 4	Field 5
Field of Application	Common measures to other sectors	Measures of train and track design	Efficient use of power traction	Optimization of operations	Use of the regenerated energy	Interaction between electricity networks
Architecture of trains						
		Design Measures		Redesign Measures		Operation Measures

Technology analysis

At high speeds, aerodynamics gain even greater significance because as speed increases energy consumption increases as well.

In Intercity and high speed trains, 60% of the traction effort is lost due to aerodynamic drag and friction in typical operation cycles. By reducing the drag by 25%, it is possible to save between 8 - 15% of traction energy.

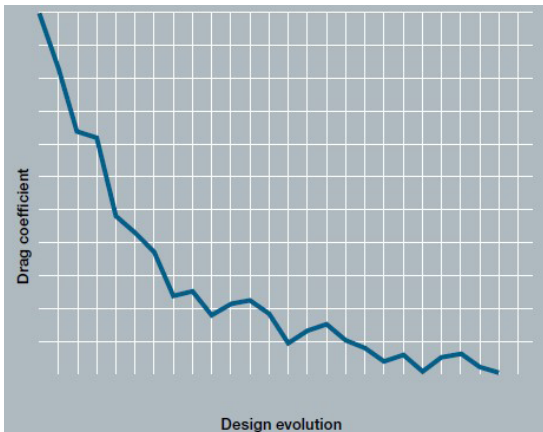

Figure 2: Iteration process from the initial design to the optimized shape. Source: Bombardier.

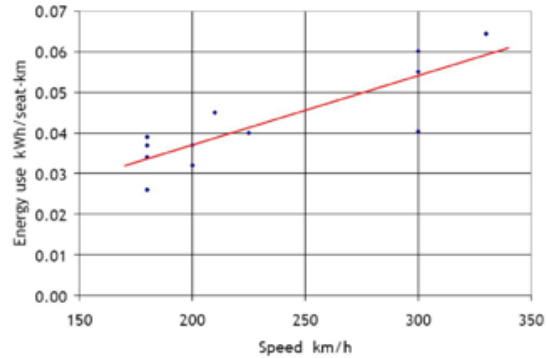

Figure 1: Relationship between energy consumption and speed in rail vehicles. Source: RSSB, T618 Traction Energy Metrics (2007).

Rail vehicle aerodynamic enhancement may have a major impact on improving energy efficiency. As well as being aesthetically appealing and dynamic in design, a streamlined train has lower drag leading to reduced energy consumption.

Another significant measure to reduce energy consumption, taken into account by rolling stock manufacturers in their future models, is to reduce train mass (without reducing the adherent mass). It supposes a reduction of the energy needed to overcome inertial and grade resistance. Mass reduction is typically achieved through reducing the weight of specific components (e.g. carbodies, bodies, bogies, etc.) or through a system-based approach to lightweighting (e.g. the articulated train design favoured by Alstom, which reduced the number of bogies by around 20% by placing them between cars). Mass reduction will benefit services with less homogeneous speed profiles (more accelerating and decelerating).

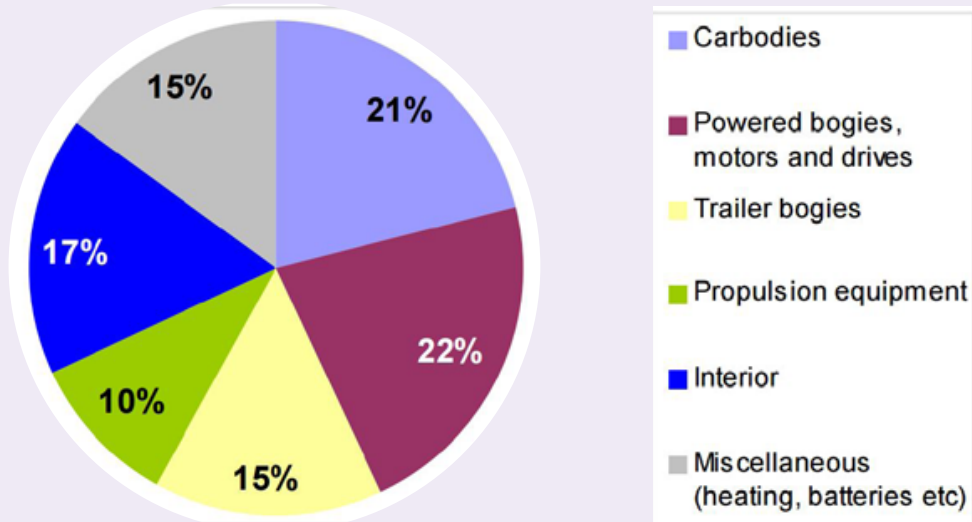

Figure 3: Typical breakdown of components in electric multiple unit trains by weight. Source: UIC EVENT (2003).

Objetives and benefits I/III

At speeds above 200 km/h aerodynamic drag dominates resistance to train motion. The following figure shows a breakdown of a train drag by component, where surface friction and drag around the bogies dominate aerodynamic drag.

The main strategies to reduce drag are streamlining the nose and tail profile of the train, reducing flow separation around the bogies, pantograph and train body by streamlining, and reducing the skin friction on the train roof and sides.

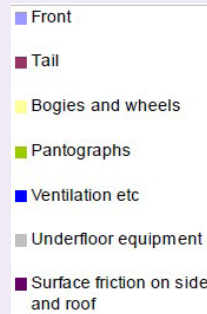

Figure 4: Typical breakdown of components contribution to drag in electric trains. Source: UIC EVENT (2003).

It is obvious that, in absolute terms, when a train is smaller, the energy consumption is lower (measured in kilowatt hours per kilometre). However, if it focuses on specific relative values for standard seat offered, small trains no longer offer better results, but on the contrary, larger trains have a lower specific consumption.

The trains size and their configuration affect the energy consumption through two key indicators:

- Mass per seat (M/seat). Increasing mass produces higher mechanical resistance, and also increase the need to brake in slowdowns and slopes.
- The drag coefficient per seat (C/seat) which translates in a larger area of section and the “wetted area” or “train skin” leading to a higher drag.

The mechanical and inertial resistance (proportional to the mass) are dominant at low speeds, while the drag (proportional to the C coefficient) is at high speeds. Therefore, it is expected that the effect of a mass variation is strongly dependent on the distance between stops and the effect of C coefficient variation is important at at long distances services with high speed trains

The table shows, for different services (characterized by their average speed and a the distance between stops), the elasticity consumption with respect to the mass and the C coefficient.

As it is shown, the elasticity of consumption with respect to mass variations is very low in high-speed services.

Elasticity of consumption with respect to the C coefficient is very important at high speeds, and it decreases when the average speed decreases until the point where it is almost negligible as in suburban and metro services.

	$\Delta\text{Cons}/\Delta\text{Mass}$	$\Delta\text{Cons}/\Delta\text{Coef. C}$
High speed long distance	0.21	0.43
Conventional long distance	0.48	0.17
High speed mid distance	0.47	0.20
Conventional mid distance	0.61	0.05
Suburban train	0.48	0.03
Metro	0.76	0.01

ΔCons : Consumption increase. ΔMass : Mass increase C: Drag coefficient.
Table 1. Elasticity of energy consumption with respect to the mass and drag coefficient.
Source: García, A. et al. (2011).

Objetives and benefits II/III

If the mass variation per seat for different configurations and train sizes is analysed significant variations can be observed as it is reflected in table 2.

From table 2 the following conclusions can be drawn:

- The mass per capacity unit decreases, as might be expected, by increasing the size of the train.
- For the same architecture a double deck can reduce the mass by 31%; and the simultaneity of the double floor and the wide body 59%.

- For the same architecture, articulated trains have 24.9% less weight per seat than non articulated, while the rodals articulated have 40% less weight per seat than unarticulated bogies train of the same capacity.

	325 seat	650 seat	dif. 650/325
Composition of classic unarticulated vehicles	969	830	0.86
Trailing. Rodals articulated vehicles	589	563	0.96
Concentrated traction articulated bogies vehicles	1,259	1,150	0.91
Concentrated traction rodals articulated vehicles	943	903	0.96
Self-propelled. Distributed traction. Unarticulated	1,045	943	0.90
Self-propelled. Distributed traction. Unarticulated double track	723	696	0.96
Self-propelled. Distributed traction. Unarticulated	429	426	0.99

Data in kg/seat

Table 2: Mass per seat for different configuration. Source: García, A. et al. (2011).

As for the variation of C drag coefficient which depends on the architecture and the train size, table 3 lists the specific values for two train configurations (medium and large size).

The table shows the following conclusions:

- Variations of the coefficient "C/seat" regarding the train size are more homogeneous than the mass variations (between 0.75 and 0.87).
- Differences between single deck, double deck and wide body trains are enormous, much larger than the variations induced by the mass.

	325 seat	650 seat	dif. 650/325
Composition of classic unarticulated vehicles	152	125	0.82
Trailing. Rodals articulated vehicles	159	129	0.81
Concentrated traction articulated bogies vehicles	127	110	0.87
Concentrated traction rodals articulated vehicles	160	143	0.89
Self-propelled. Distributed traction. Unarticulated	429	426	0.99
Self-propelled. Distributed traction. Unarticulated double track	119	101	0.85
Self-propelled. Distributed traction. Unarticulated	83	62	0.75

Table 3: C drag coefficient per seat for different configuration. Source: García, A. et al. (2011).

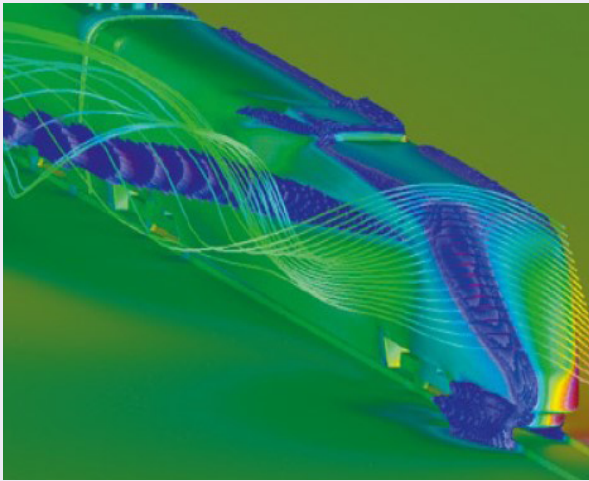

Figure 5: Visualization of flow ribbons - simulation of a high speed train running under cross-wind conditions. Source: Bombardier.

Superimposing the principles of natural pre-selection and evolution to an advanced computer-modelling approach that creates the best possible shape enables the optimization of the latest vehicle designs, creating the lowest energy consumption and maximum stability.

Regarding the elasticity of consumption in terms of C coefficient, it is very important for high speed (decreases strongly the average speed of the service) to the point of being almost negligible in suburban and metro services.

However, the latest strategies to reduce drag are based on bionics. It consists of the application of biological methods in nature to the study of engineering systems with the use of sophisticated computer modelling techniques.

Already successfully adopted within the automotive and aerospace industry to create highly energy-efficient designs, bionics science recognizes that Nature's own evolutionary processes may help to ensure continuous improvement in a "survival of the fittest" regime.

Applications

Real applications. Demonstrator

Author	Explanation	Benefits
Bombardier Zefiro	It is the new benchmark for high speed trains in terms of low aerodynamic drag combined with high stability, whilst cruising under cross-wind conditions. To achieve this balance, Bombardier has used state-of-the-art Computer Aided Engineering (CAE) methods and tools, incorporating Computer Aided Design (CAD) and Computational Fluid Dynamics (CFD).	Bombardier's aerodynamic modelling ensures the optimum configuration of: <ul style="list-style-type: none"> •Alternative front and end sections of the train. •Spoilers. •Pantograph integration solutions. •Bogie space envelope and fairings.

Author	Explanation	Benefits
Tokaido Shinkansen Line. Series N700	The Series N700, based on the high potential of the Series 700, was introduced in 2005. The rail vehicles have been designed with tilting mechanisms and advanced aerodynamic features to increase its energy efficiency and maximum speeds whilst reducing journey times on the Tokaido Shinkansen.	The Series N700 have 75% more seats and 14% lower mass per train resulting in significantly enhanced speed, comfort and energy performance.

Author	Explanation	Benefits
Automotrice à grande vitesse (AGV). France Alstom	The AGV is the most energy efficient rail car designed adhering to the Technical Specifications for Interoperability (TSI) standards. It is the world's first train designed to combine articulated carriage architecture with a distributed traction system and synchronous permanent magnet motors (PMM). It is built with aluminium alloys to reduce the overall weight by 700 kg compared to using steel.	Designed for operation at very high speed (max. 360 km/h), it demonstrates that design efficiencies aimed at reducing weight and increasing seat capacity can deliver energy consumption some 15% lower than that of existing TGVs at 300 km/h.

Bibliography

- Yamamoto, T. (2015). "Recently Studies and Developments of Energy Saving Technologies in the Field of Railway Vehicles". QR of RTRI, Vol. 56, N° 4. November 2015.
- Comparing environmental impact of conventional and high speed rail. Planning and regulation. Network Rail.
- Resistance is futile: how aerodynamics inform train design. Available at: Railway-technology.com (Accessed 29/07/2016).
- Energy consumption and CO₂ impacts of High Speed Rail: ATOC analysis for Greengauge 21. ATOC analysis for Greengauge 21 on the CO₂ impacts of High Speed Rail.
- AeroEfficient Optimized Train Shaping. EcoActive Technologies. Bombardier.
- García, A. et al. (2011). Influencia de la arquitectura y el tamaño de los trenes en sus costes operativos y su consumo de energía. Fundación de los Ferrocarriles Españoles. Madrid (Spain).

1.2.2. New materials

Introduction

Efficiency

Rail vehicles are conventionally made of alloys such as aluminium, steel and titanium mainly, but these materials have a certain number of disadvantages compared with composite materials. Composite materials meet stringent requirements even at aggressive operating conditions such as high temperature, pressure, moisture, corrosive environment or high stress and, at the same time, reduce energy consumption, CO₂ emissions (5%) and operating costs.

Investment

Although initially the new material proposed is more expensive than metallic alloys traditionally used for a train structure, this difference is compensated with a simple manufacturing process in which it is possible to obtain complex geometrical forms by moulding, hence reducing the cost of assembly and the later cost of maintenance.

Scope of the technology

- ➔ A train car body made using composite materials reduces the train weight by 20% to 30%.
- ➔ Weight reduction reduces the total amount of energy used and thus there are a decrease of at least 5% of CO₂ emissions.
- ➔ Composite materials have lower life cycle cost (16%).
- ➔ Composites also have lower environmental impact (26%).
- ➔ New materials reduce the operation and maintenance cost.

Field of application

	Field 0	Field 1	Field 2	Field 3	Field 4	Field 5
Field of Application	Common measures to other sectors	Measures of train and track design	Efficient use of power traction	Optimization of operations	Use of the regenerated energy	Interaction between electricity networks
New materials						
		Design Measures		Redesign Measures		Operation Measures

Technology analysis

The railway sector currently uses composites only for non-bearing structural components. It is common to use steel for the car body of a train. In fact, European legislation does not allow train manufacturers to use only composites for train car bodies, although legislation is being adapted to enable using this light, durable material in the construction of trains.

The most important feature governing the choice of material and form of construction for any component is its structural integrity. A designer looking for a substitute for the conventional steel construction method cannot achieve success by using one type of material alone.



Figure 1: Composite train cab. Source: Alcan Airex Composites.

In this way, a “Sandwich Construction” is proposed which consists essentially of two outer facing layers and an inner core.

The core must be rigid enough perpendicularly to the faces to prevent crushing and its shear stiffness must be large enough to prevent shear deformations. A sandwich absorbs the load and distributes the stresses over a much larger area.

Some of the currently used core materials are:

- Corrosion Resistant Aluminium Honeycomb: It possesses high strength and rigidity-to-weight ratio.
- Aluminium Flex Core: It is used to manufacture highly contoured sandwich panels.
- Aluminium Corrugated Honeycomb: It possesses high compressive, shear and crushing strength.
- Fibre Glass Reinforced Polyimide Honeycomb: It has good dielectric and insulation properties.
- Aramid Fibre/Phenolic Resin Honeycomb: It possesses high strength at low densities, easily formable, fire resistant, water and fungus resistant, good dielectric and thermal properties.
- Non-metallic/Reinforced Plastic Flex Core: It is applied wherever extreme curvature dictates a flexible cell.



Figure 2: Composite rail seat. Source: Alcan Airex Composites.

International experience reveals that the composites being used for various applications especially in railways mostly comprise metal/non-metal honeycomb and sandwich constructions. These pictures show two main applications for which composites are routinely employed at present.

Objetives and benefits

Metallic materials are heavier than composites and thus require additional power traction and important energy consumption.

If a train car body is made of composite materials, its weight will be reduced by 20% to 30%. This weight reduction will lead to lower energy consumption and a reduction of at least 5% of CO₂ emissions (Martijn Wolf, Technical Consultant at Ricardo Rail).

In the field of very high speed railways, a weight reduction will result in higher speed, higher transport capacities and/or enhanced passenger comfort whilst keeping a good energy balance. On the other hand, in the field of urban and sub-urban rolling stock a weight reduction will lead to enhance acceleration, hence increasing capacity in terms of passenger flow/hour, provided that the adherent mass is the same.

Composites are able to meet diverse design requirements with significant weight savings as well as high strength-to-weight ratio as compared to conventional materials.

Some advantages of composite materials over conventional one are:

- Tensile strength of composites is 4 to 6 times greater than that of steel or aluminium.
- Improved torsional stiffness and impact properties.
- Composites have higher fatigue endurance limit (up to 60% of the ultimate tensile strength).
- Composite materials are 30-45% lighter than aluminium structures designed to the same functional requirements.
- Lower embedded energy compared to other structural materials like steel, aluminium etc.
- Composites are less noisy while in operation and provide lower vibration transmission than metals.
- Composites are more versatile than metals and can be tailored to meet performance needs and complex design requirements.
- Composites offer excellent fatigue, impact, environmental resistance and reduced maintenance.
- Composites enjoy reduced life cycle cost compared to metals.
- Composites exhibit excellent corrosion resistance and fire retardancy.

	COMPOSITES	STEEL	ALUMINIUM
Density [g/cm ³]	1.8	7.9	2.7
Tensile Strength [Mpa]	240	250	240
Elastic Modulus [Gpa]	23	210	70
Linear Thermal Expansion [10E-6/°k]	10	12	24

Table 1: Typical structural properties of composites and conventional materials. Source: Exel Composites.

	COMPOSITES	STEEL	ALUMINIUM
Complex shapes, integrated functions	yes	no	limited
Electrical insulation	yes	no	no
Thermal insulation	yes	no	no
Corrosion resistance	yes	no	average
Low maintenance	yes	no	yes
Durability	yes	average	yes

Table 2: Characteristics comparison. Source: Exel Composites.

Applications

Theoretical applications

Author	Explanation	Benefits
Alstom	ALSTOM has developed the concept of a “Multi-Material Intermediate Coach” prototype, whose central and end parts are made of composite materials, in order to validate potential weight gain of such a structure, with the mechanical performances maintained and at identical costs. The project has studied the behaviour of different types of composites integrated in the roof or side walls of rail vehicles.	The feasibility and interest of such a change in conventional materials is to improve the performance/weight ratio whilst complying with economic constraints and constraints inherent to passenger transportation in general: safety, ride quality, reliability and maintainability.
NewRail (United Kingdom)	“The Composite Material Research Requirements of the Rail Industry” is a study that belongs to the COMPOSIT thematic network on “The Future Use of Composites in Transport”. The report provides an overview of the applications in which composite materials are currently employed.	There are a variety of different processing techniques for the manufacture of composite rail vehicle parts. The objective is to find products that are the same cost, or even cheaper, than equivalent metallic designs. Availability of lighter vehicles. Long life taking into account fatigue. Excellent corrosion resistance and fire retardancy.
Indian Railways	Composites have been identified as an important material for application in the Indian Railways for various agencies such as Research Designs & Standards Organization (RDSO)-Lucknow, Integral Coach Factory (ICF)-Chennai, Rail Coach Factory (RCF), Kapurtala and Carriage Repair Workshops. Some of these applications are: Gear case for locomotives, modular toilet units, bulkheads, interior walls and doors and folding tables.	The benefits associated to composite materials have been identified by Indian authorities such as: Lower energy consumption. Lower operation and maintenance cost. Minimal environmental impact.
Korean Tilting Train eXpress (TTX)	The potential of polymer composite car-body structures for the Korean Tilting Train eXpress (TTX) has been investigated.	Compared to the steel scenario, the hybrid composite variant has a lower life cycle cost (16%) and a lower environmental impact (26%).

Bibliography

- Biswas, S. et al. (2001) “Composite Technology Development and Commercialization - An Indian Initiative”. 6th ASEAN Science and Technology Week, Brunei Darussalam, September 17-19.
- Nangia, S. et al. (2000) “Composites in Railways”. SEARCH, February.
- RailTech. REFRESCO: Construction composite train possible following regulation change. UE.
- NewRail (2004). The Research requirements of the transport sectors to facilitate and increased usage of composite materials. Part III: The Composite Material Research Requirements of the Rail Industry.
- Campus, E. et al. “Use of Composite Materials in Railway Applications”. ALSTOM Transport in collaboration with SNCF Direction du Matériel Centre d’Ingenierie du Matériel.
- Castella, P.S. et al. (2009). Integrating life cycle costs and environmental impacts of composite rail car-bodies for a Korean train. Life Cycle Assessment (2009) 14:429-442. DOI 10.1007/s11367-009-0096-2. Korea.
- Cheul-Kyu Lee, et al. (2016). Application of the integrated ecodesign method using the GHG emission as a single indicator and its GHG recyclability. Journal of Cleaner Production Volume 112, Part 2, 20 January 2016, Pages 1692-1699. Korea.
- Cheul-Kyu Lee, et al. (2009). Global warming effect Comparison of each material for railway vehicle. Korea.

1.2.3. Life cycle and recycling

Introduction

Efficiency

The life cycle of rail vehicles is approximately 30-40 years and it includes many stages that must be taken into account in order to improve the energy efficiency. One of these stages is the recycling, an end-of-life rail vehicle treatment in which the recovery of raw materials is a sustainable type of creation of value. A wide variety of materials can be re-processed and then secondary raw materials can be re-used.

Investment

The recovery will depend on many factors such as: the existence of infrastructure of specialized material recycling, accessibility to recovery technologies, new types of materials, demand for recycled materials and refurbished parts, legal regulations forcing to achieve required recovery rates and the expectations and environment protection policies applied by the rolling stock owners and users.

Scope of the Technology

- ➔ With all stages of a rail vehicle life cycle, it is possible to reduce the energy consumption.
- ➔ Efficient end-of-life rail vehicle treatment can boost the use of renewable energy.
- ➔ The management of all stages of a rail vehicle life cycle and the recycling process distributes the producer's responsibilities related to environmental regulations.
- ➔ More than 95% recoverability rate.

Field of application

	Field 0	Field 1	Field 2	Field 3	Field 4	Field 5
Field of Application	Common measures to other sectors	Measures of train and track design	Efficient use of power traction	Optimization of operations	Use of the regenerated energy	Interaction between electricity networks
Life cycle and recycling						
		Design Measures		Redesign Measures		Operation Measures

Technology analysis

The process of disposal of rail vehicles includes the following stages:

- Forwarding the rolling stock for recycling.
- Pre-treatment.
- Dismantling.
- Shredding.
- Treatment of recovered materials and parts.

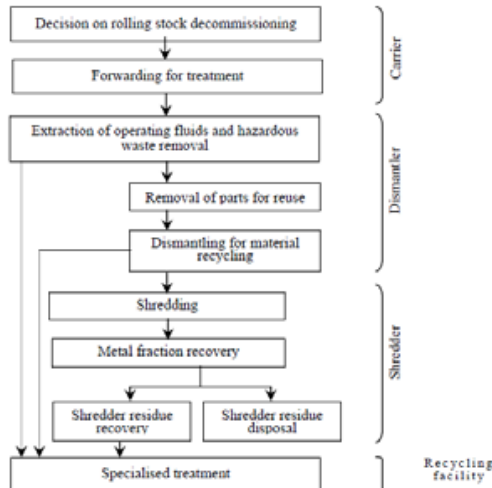

Figure 1. Recycling procedure for end-of-life rail vehicles. Source: WIT Transactions on The Built Environment (2014).

1. Forwarding the rolling stock for recycling.

The first step is to make the decision of decommissioning of a vehicle and forwarding it to a place where its dismantling will be safe for the environment and whose recovery rate will be high. The decommissioning decision may be made because of rolling stock damage, repeated malfunctions, high repair costs, excessively high maintenance costs compared to new models available in the market as well as product obsolescence.

2. Pre-treatment.

Before dismantling the Rolling Stock should be prepared in such a way that it remains safe for human health and the environment at further stages of the recycling process. The stage of initial treatment includes vehicle draining and removing hazardous waste and pollutants. Operating fluids (oils, brake fluids, antifreeze) removed from the vehicle should be stored in separate containers and then forwarded to specialized facilities responsible for material recycling or energy recovery (oils). Parts or components that are to be reused as spares are not drained.

3. Dismantling.

In the dismantling process, parts and subcomponents that can be further used or recycled are removed. In the first place, parts and subcomponents that are to be further used are retrieved. These subcomponents are: bogies, bogie frames, wheel sets, couplings, buffers, springs, control valves, brake systems and doors. Some parts can be directly used in other rail vehicles and some will require refurbishment to regain original operating parameters.

4. Shredding.

The main task of an industrial shredder is the recovery of the metal fraction. Ferrous and non-ferrous metals are almost fully treated to become recycled materials. Shredder residue may be further segregated for reuse or partly combusted with energy recovery due to its high calorific value. Approximately 50% of the light shredder residue contains a combustible fraction that can be thermally treated.

5. Treatment of recovered materials and parts.

All dismantled elements and components at the stage of initial and proper dismantling (except parts and subcomponents that are good for direct reuse) are forwarded to specialized recycling facilities where they are treated with the use of available technologies.

Raw material	Total energy consumption for material recycling (MJ)
Steel (low alloyed)	168,000
Steel (high alloyed)	444,000
Aluminium (50% secondary)	77,500
Glass	9,000
Copper	36,000
Total	734,500

Table 1. Recycling behaviour of a rail vehicle. Source: Siemens Transportation Systems (2006).

Taking into account the versatility of the applied materials in rail vehicles, the total energy consumption for material recycling are shown in table 1.

Objetives and benefits

Manufacturers and owners of rolling stock must consider ecological aspects when conducting their activities. It is worth remembering that environmental benefits should not only cover the stage of operation but also the other stages of the life cycle. This is the only approach that will ensure full competitiveness of rail transport. Therefore, when designing and building new rolling stock, the manufacturers must take into account the entire life cycle of a vehicle that covers the production (design and building), operation (use and maintenance) and end of life (vehicle disposal).



Figure 2: Description of the life cycle stages.
Source: Siemens Transportation Systems (2006).

Considering the whole life cycle of a rail vehicle, the energy efficiency of it depends on:

- Vehicle design (electrical and mechanical equipment).
- Materials / raw materials.
- Manufacturing.
- Delivery to the customer.
- Energy losses (trains resistance, traction systems, etc.).
- Maintenance.
- Disassembling and recycling.

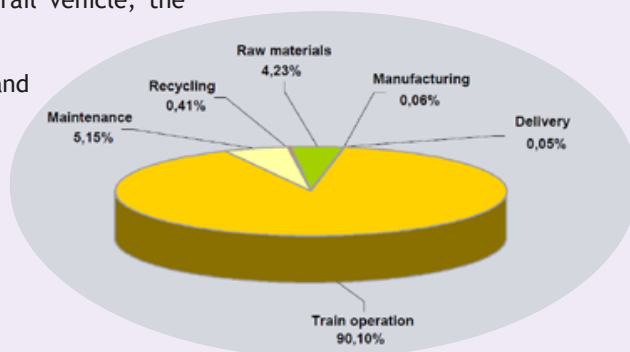

Figure 3: Energy consumption of a rail vehicle for the overall life cycle and 30 years of operation. Source: Siemens Transportation Systems (2006).

The extent of the environmental impact in the last stage of the life cycle is related to the successful implementation of the 3R principle: **Reduce, Reuse and Recycle**. Already at the design stage of new rail vehicles and while developing production technologies, the amount of waste to be generated upon disposal needs to be minimized (reduce). At the stage of operation, a reuse of the greatest possible number of parts and subcomponents is assumed directly or following refurbishment (Reuse). At the stage of disposal of a rail vehicle the greatest possible amount of waste needs to be recycled (Recycle).

There are no regulations related to the recovery and recycling of rolling stock at EU level but owing to social responsibility and the possible economic benefits, the reasons behind the growing need for effective end-of-life rail vehicles treatment can be summarized as follows:

- Energy efficiency issues.
- Higher raw material costs.
- Stricter landfill legislation and need for landfilled waste reduction.
- Other environmental regulations related to producer's responsibility.
- Customers' increasing product-related environmental requirements.
- The competitive advantage gained through eco-friendly products.

Applications

Theoretical applications

Author	Explanation	Benefits
ECO4 Bombardier	Taking into account the potential environmental impact of a product throughout its entire life cycle at the very beginning of the design process, Bombardier takes an overall approach towards developing EcoEfficient products that contribute to sustainable mobility.	EcoEfficient Optimized Environmental Performance achieves: More than 95% recoverability rate. Enhanced and safer end of life treatment. Maximum value at end of life and reduced cost for waste treatment. Efficient use of natural resources. Low emissions and a low carbon footprint.

Real applications. Demonstrator

Author	Explanation	Benefits
Coradia Nordic, Alstom (2005)	The Coradia Nordic regional train, supplied in 2005, is designed to meet all passenger requirements in terms of comfort and accessibility. But also, is an environmentally friendly train using a regenerative braking system and providing a high Recyclability rate.	During design and manufacturing, environment-friendly processes and products are applied. It is the first multiple unit that ensured a reuse and recovery of materials on the level of 95% of the vehicle weight.

Author	Explanation	Benefits
Inspiro Metro Trains (Siemens), Metro Warszawskie, Warsaw, Poland (2013)	The experience gained by Siemens in Norwegian Oslo was then used for designing and manufacturing Inspiro railcars for the Warsaw subway that were introduced in 2013. The Inspiro trains are built in compliance with the ISO-14021 ecological standard.	The materials used for the production of a 6-unit train with a gross weight of 158.2 ton can be recovered in the recycling process in 94.8%. Only 5.2% of the total mass of the train is waste that has to be landfilled and cannot in any way be reused.

Bibliography

- Siemens Transportation Systems (2006). Life cycle analysis of the energy consumption of a rail vehicle. September 2006.
- Merkisz-Guranowska, A. et al. (2014). Rail Vehicles Recycling. Poznan University of Technology, Warsaw University of Technology and Rail Vehicles Institute TABOR. WIT Transactions on the Built Environment, 135.
- UNIFE Association of the European Rail Industry, Sustainable Transport Committee. Recyclability and Recoverability Calculation Method-Railway Rolling Stock. Brussels, 2013.
- Siemens, official website: www.siemens.com. (Accessed 31/07/2016).
- Bombardier. EcoEfficient Optimized Environmental Performance. EcoActive Technologies. Available at: <http://www.bombardier.com/en/transportation/products-services/innovation-driver/eco4-technologies/eco-efficient-optimised-environmental-performance.html> (Accessed 1/08/2016).

1.2.4. Mechatronics

Introduction

Efficiency

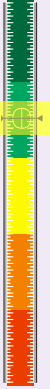

Future railway vehicles must be more cost-effective and energy-efficient. This can be done by implementing new mechanical configurations of running gear which can only be achieved through an extensive use of advanced electronic control, embedded within the vehicle system from the earliest stages of the design process.

Mechatronic systems introduction in railways running gears reduces wear, noise and increases ride comfort, with a lower need of traction energy.

Investment



Assuming decreasing costs of electronic components in the next years, simulations show that the new running gear can offer a better running performance than a conventional running gear under all operation conditions in combination with a low maintenance effort.

Scope of the technology

- ➔ The synergy of the mechanics and the electronics in railways reduces traction energy.
- ➔ Reduced wear, which implies longer maintenance intervals and higher speed development.
- ➔ Decreased vehicle mass, which provides lower emissions, vibration, noise and increase the comfort, with a high-quality service.
- ➔ True interoperability on different national track networks.
- ➔ Reduced track impact and lower access charges on networks with performance-dependent fees.

Field of application

	Field 0	Field 1	Field 2	Field 3	Field 4	Field 5
Field of Application	Common measures to other sectors	Measures of train and track design	Efficient use of power traction	Optimization of operations	Use of the regenerated energy	Interaction between electricity networks
Mechatronics						
		Design Measures		Redesign Measures		Operation Measures

Technology analysis

The application of methods and tools from aerospace and robotics to railway vehicles has a tradition of more than 25 years.

If it is assumed that there will be actuators, sensors and controllers at the heart of future railway vehicles, it is possible to discover ways of exploiting the synergy of the mechanics and the electronics to achieve a superior solution. This is of course what the discipline of mechatronics is about, not just adding electronic control to an existing mechanical system, but re-designing the mechanical system to take full advantage of control.

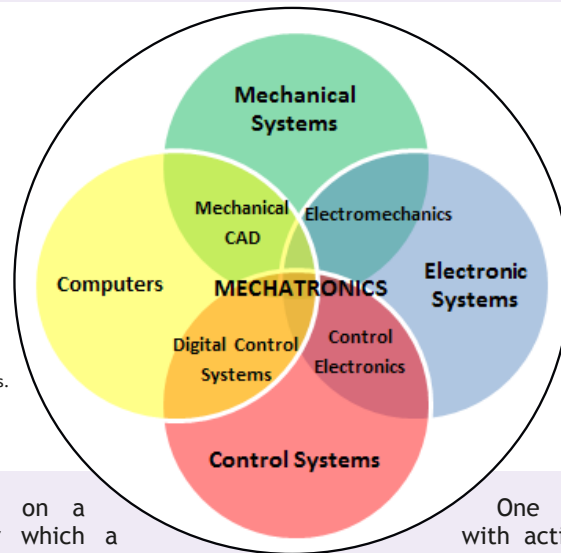

Figure 1: Relationship between mechatronics and other systems.
Source: Own elaboration.

The main systems on a railway vehicle for which a mechatronic approach is appropriate are the suspension, traction and braking systems. Of these, the suspension system is of the greatest interest, partly because traditionally it has been wholly mechanical, but also because it is more fundamental to the complete vehicle design than either of the other two.

In order to deal with high speed railway demands new vehicles are required which can run stably at high speeds and take curves in a reasonable manner and which have a soft secondary suspension to provide modern standards of ride quality. To achieve these objectives it is necessary to design and implement active systems in railway vehicles.

One fundamental problem with active vehicle systems is the interaction between structural dynamics, the forces between wheel and rail, and the control systems. Accordingly, a proper understanding of the engineering science is needed for an integrated application of electronic and mechanical components to achieve the optimum systems design of railway trains.

The introduction of active systems in railway running gears leads to a new field with many interesting challenges in which, for instance, a bogie with driven independently rotating wheels using practical sensors for feedback control has been developed. This reduces wear and roll noise and increases ride comfort in combination with a low maintenance effort.

Objetives and benefits

In order to extend the train capacity and reduce the energy consumption per passenger, the vehicle concept of the New Generation Train (NGT) is configured as a double-deck high-speed multiple unit train set. This leads to the following list of requirements:

The running gears...

- Have to meet all safety standards e.g. concerning running stability.
- Have to allow a planar alleyway for passengers at the lower level of a double-deck vehicle (low-floor design).
- Have to contribute to the traction of the train set.
- Have to reduce wear of the wheels and the rails.
- Have to reduce rolling noise.

Mechatronic systems for active steering and running gear control in principle offer an enormous potential for enhancements regarding this list of demands, so in this way, a concept for a novel mechatronic running gear has been developed.

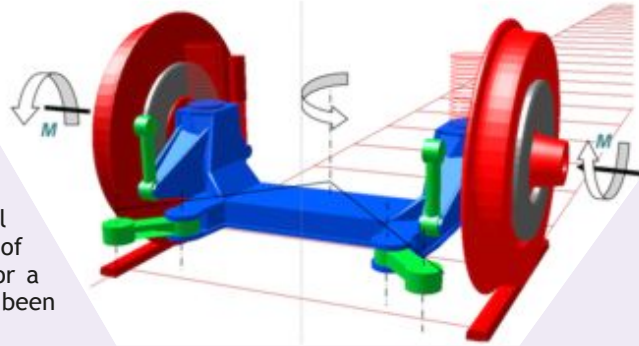

Figure 2: Unit with carrier and independently torque-controlled wheels for the mechatronic running gear. Source: Robotics and Mechatronics Center.

The basic idea of the novel mechatronic running gear concept consists of independently rotating wheels with a mechatronic guidance system to overcome the disadvantages of conventional wheelsets under certain operating conditions.

Its major components are the feedback-controlled single wheels and the wheel carrier, which may be aligned along a curve radius. The wheel drives serve two purposes: they are responsible for traction and lateral motion of the wheel pair. This way the carrier-wheels-unit may be adjusted to the middle of the track and may be steered into curves so that low-wear and -noise running characteristics are achieved.

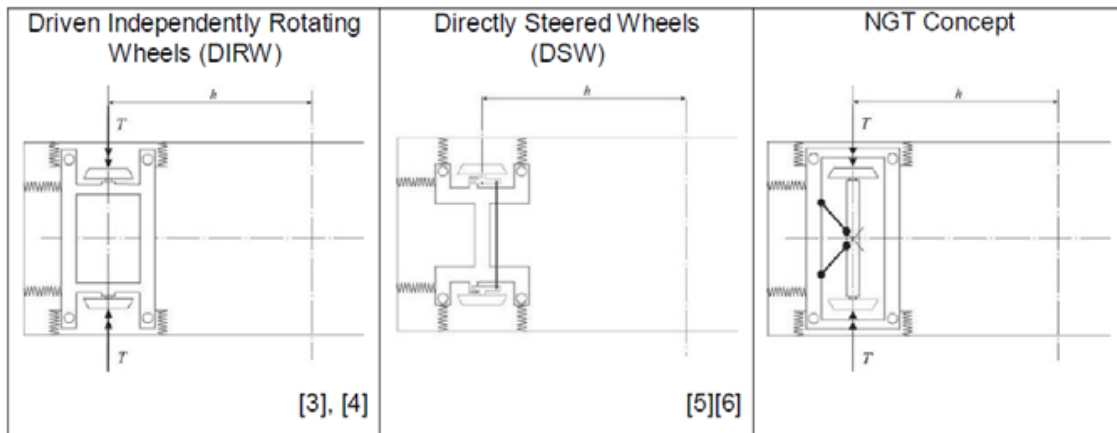

Figure 3: Steering principles for independently rotating wheels. Source: Robotics and Mechatronics Centre.

At most operation conditions a conventional wheelset offers a good guidance quality, but at very high speed and in narrow curves problems may occur on vehicles with conventional wheelsets, for instance instability (high speed) or high wear and vibrations (curves).

The aim of the concept of the NGT is the development of a running gear, which offers gear under all operation conditions in combination with a low maintenance effort and a better running performance than a conventional running. This means a lower emission level of vibrations to the ground and the air as well as less friction at curves and therefore a lower need of traction energy.

Applications

Theoretical applications

Author	Explanation	Benefits
Mechatronics in Japanese rail vehicles: active and semi-active suspensions. K. Tanifuji, S. Koizumi, R. Shimamune	This paper introduces the present state of mechatronics application to the railway vehicle in Japan. The objective mechanisms in the vehicle are classified into five categories: <ul style="list-style-type: none"> • Drive and braking. • Car body tilting. • Steering. • Pantograph. • Suspension. Making a brief research and development of mechatronic systems available in each category.	The expected benefits of mechatronics technology are: <ul style="list-style-type: none"> • Ride comfort. • Higher speed development. • High-quality service. • Saving track maintenance cost.

Real applications. Demonstrator

Author	Explanation	Benefits
Bombardier FLEXX Tronic Technology	FLEXXTronic is based on the innovative mechatronic platform developed by Bombardier's R&D Engineering team. FLEXX Tronic technology provides unique active radial steering and bogie stabilization (ARS) capabilities.	The major benefits of FLEXX Tronic technology include: <ul style="list-style-type: none"> • True interoperability on different national track networks. • Reduced wheel and rail wear. • Longer maintenance intervals. • Decreased vehicle mass, vibration and noise. • Reduced track impact and lower access charges on networks with performance-dependent fees.

Bibliography

- R. M. Goodall, W. Kortüm (2002). "Mechatronic developments for railway vehicles of the future". *Control Engineering Practice*, 10(8): 887-898.
- B. Kurzeck, L. Valente. "A novel mechatronic running gear: concept, simulation and scaled roller rig testing". Institute of Robotics and Mechatronics. DLR (German Aerospace Centre).
- K. Tanifuji, S. Koizumi, R. Shimamune (2002) "Mechatronics in Japanese rail vehicles: active and semi-active suspensions". *Control Engineering Practice*, 10(9): 999-1004.
- Robotics and Mechatronics Centre: Railway Systems. Available at: dlr.de (Accessed 05/09/2016).
- Bombardier: The Evolution of Mobility. Available at: bombardier.com (Accessed 06/09/2016).

1.3. Non-traction loads

1.3.1. Renewable sources in non-traction loads

1.3.1. Renewable source in non-traction loads

Introduction

Efficiency

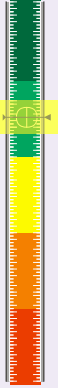

Installing equipment that provides energy from renewable sources (e.g. solar panels, wind generators) to feed non-traction loads in both facilities and on-board trains may have a significant impact in the energy costs of a railway system. Moreover, such equipment may reduce noticeably the CO₂ emissions, hence making railways more environmentally friendly.

Investment

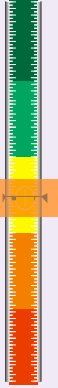

Installing solar panels, wind generators and other systems that harvest energy from renewable sources requires an important investment, particularly if a large area (such as the roof of a train depot) is to be covered with solar panels. However, the cost of the energy that is no longer provided by the general grid may cover this investment in a matter of 9-10 years in medium and large facilities.

Scope of the technology

- ➔ Covering part of the energy needs of the railway system through local renewable sources may reduce significantly the amount of energy imported and the ratio of CO₂ emitted per kWh consumed is reduce. Moreover emissions at local level may be reduced.
- ➔ Under some circumstances, part of the energy generated from renewable sources may be exported back to the general grid.
- ➔ One of the objectives of this measure is to increase the use of the renewable energy. In order to reduce CO₂ emissions, FGV equipped four of its depots in the cities of Valencia and Alicante with solar panels. Up to 10,400 panels where installed, accounting for 17,700 m². These installations save more than 3,500 tons of CO₂ emissions and more than €1 million per year.

Field of application

	Field 0	Field 1	Field 2	Field 3	Field 4	Field 5
Field of Application	Common measures to other sectors	Measures of train and track design	Efficient use of power traction	Optimization of operations	Use of the regenerated energy	Interaction between electricity networks
Renewable sources in non-traction load						
		Design Measures		Redesign Measures		Operation Measures

Technology analysis

Railways are inherently efficient when compared to other transport means such as road transportation. As of 2012, railways transported over 8% of the world's passengers and goods but they were only responsible for 3.6% of the global CO₂ emissions (UIC, 2015). Nowadays the energy supplied to railways (both vehicles and infrastructure) comes from oil products and electricity (coal has become marginal). The global percentage of electrified tracks is about 30% although this share is much higher (up to 80%) in countries such as Italy or South Korea (UIC, 2015).

However, even electrified lines have an impact on CO₂ emissions as the source of such energy is still mostly a mix of oil and coal products. The same happens to stations, depots and other facilities that are part of a railway system.

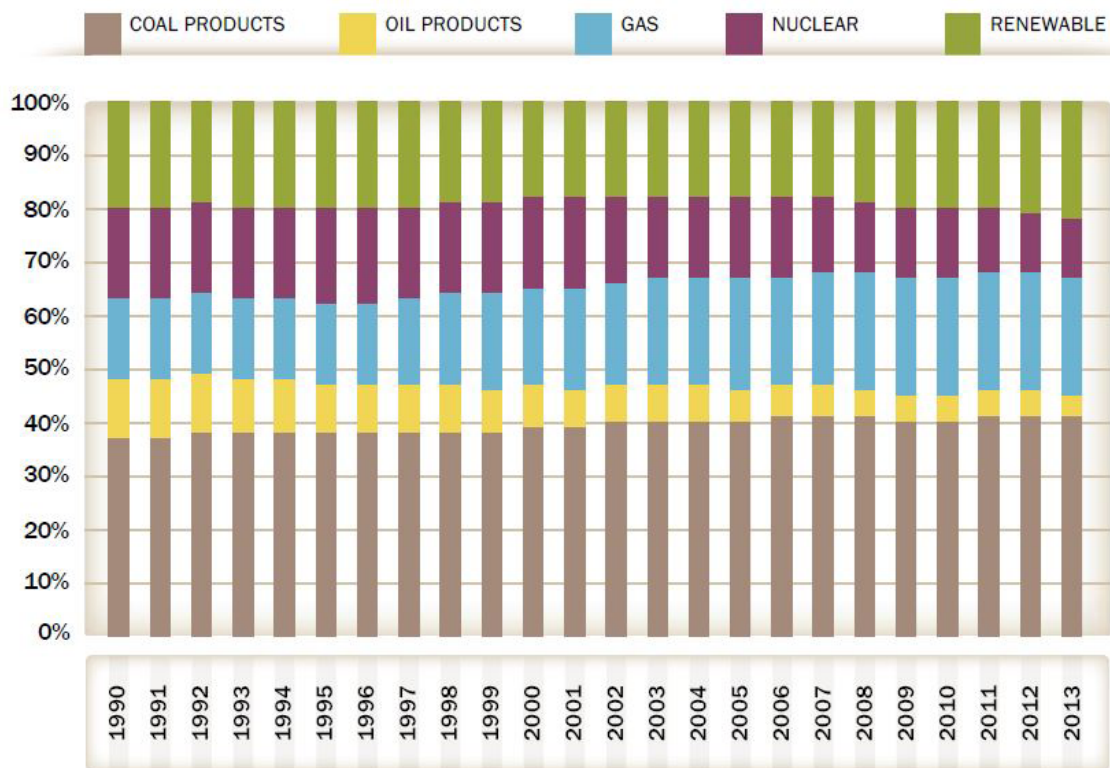

Figure 1: World electricity production mix evolution, 1990-2013. Source: UIC Handbook 2016.

The main share of the energy supplied to a railway system is use for traction. However, many non-traction loads (such as train auxiliary systems, lightning and HVAC in stations and depots, etc.) have also a significant impact in the global energy consumption of a railway network. In order to reduce CO₂ emissions and make railways more environmentally sustainable, it is possible to implement local renewable energy sources to cover some of these non-traction loads, both in fixed facilities and on-board the rolling stock.

There are different renewable energy sources that may be used to supply part of the energy needs of a railway system, such as geothermal energy or mechanical energy harvested with piezoelectric elements. However, the most common and efficient devices are solar panels and wind generators.

Objetives and benefits

Renewable local sources such as photovoltaic panels and wind generators may be installed to feed railway facilities such as stations and depots. Likewise, trains may be equipped with renewable energy systems to power some auxiliary needs like lightning or HVAC. The aim of both measures is to partially power non-traction loads with clean energy and thus reduce CO₂ emissions.

•Facilities.

Railway facilities such as depots and stations tend to occupy large areas and have large roof zones where photovoltaic panels may be installed to cover some of their energy needs. This approach has been studied in deep over the last years (Faranda and Leva, 2007) and there are some real examples with rather good results. For instance, Ferrocarrils de la Generalitat Valenciana FGV (the main railway operator of the Valencia region in Spain) installed over 10,000 panels on the roofs of four of its depots in the cities of Valencia and Alicante. These four installations combined generate more than 3 million kWh/year and help save about €1 million and more than 3,500 tons of CO₂ (FGV, 2013).

Solar panels may be combined with wind generators to increase the amount of renewable energy available. In India, up to 300 railway stations are equipped with such combination (Vijaykumar, 2016), and the energy thus harvested is used to power water supply systems, gate signals, lightning, etc.



Figure 2: Solar tunnel Antwerp. Source: Gifford, J. (2011).

Other essential infrastructure facilities in a railways system are electric substations. Their role is to transfer energy supplied from the electrical grid and distribute it to all subsystems within the railway network. Substations have their own auxiliary systems that may consume as much as 60 MWh per year and substation (Vrignaud, 2011). In order to supply part of this energy, SNCF has developed a program called ZAC (Zero Auxiliary Consumption) which aims to equip all substations with a combination of solar and wind generation devices.

Another alternative is to harvest the mechanical energy generated by the passing of trains. By installing piezoelectric devices in the track, part of the vibration caused by the trains may be used as a power source for wireless sensors (Wang et al. 2015) or other auxiliary track-side equipment (Zhang et al. 2016).

•On-board vehicles.

Although using solar panels and other renewable energy sources on-board trains is a more complex option, it is also possible to feed some of the train auxiliary systems using such technology. In India, there is an ongoing project to install solar panels on the top of diesel trains to power lightning and ventilation (Financial Express, 2016). There are already some narrow gauge trains operating with this system, and a prototype broad gauge Diesel Multiple Unit is on trial. Equipping the more than 63,000 coaches that operate along the Indian Railway system could save about €1.3 million in diesel and reduce dramatically their CO₂ emissions (Vijaykumar, 2016).



Figure 3: A train coach fitted with solar panels in India. Source: Financial Express, (2016).

Applications

Theoretical applications

Author	Explanation	Benefits
R. Faranda S. Leva	These authors conducted a preliminary technical and economic analysis on the implementation of photovoltaic panels in railway stations.	According to their simulations, using solar panels to supply stations may not be economically feasible for small facilities, but in medium and large stations (with an estimated annual energy consumption of 250,000 kWh) the installation of solar panels may be economically profitable after 9-10 years.

Real applications. Demonstrator

Author	Explanation	Benefits
Ferrocarrils de la Generalitat Valenciana (FGV)	In order to reduce CO ₂ emissions, FGV equipped four of its depots in the cities of Valencia and Alicante with solar panels. Up to 10,400 panels were installed, accounting for 17,700 m ² .	The four installations combined generate 3.2 million kWh/year. These installations save more than 3,500 tons of CO ₂ and more than €1 million per year.

Bibliography

- UIC (2016). Railway Handbook 2016. Energy Consumption and CO₂ emissions. Paris (France). Available at: http://uic.org/IMG/pdf/iea-uic_railway_handbook_2016_web.pdf (accessed 15/11/2016).
- Faranda, R. (2007). Energetic sustainable development of railway stations. Power Engineering Society General Meeting. Tampa, USA, June 24-28, 2007.
- FGV (2013). Memoria de Sostenibilidad 2012-2013 (Sustainability Report 2012-2013). Available at: <http://www.fgv.es/la-empresa/memorias-de-gestion> (accessed 02/08/2016).
- Vijaykumar, N. (2016). 5 ways the Indian Railways is adopting renewable energy to reduce its carbon footprint. Available at: <http://www.thebetterindia.com/49266/indian-railways-renewable-energy> (accessed 02/08/2016).
- Vrignaud, G. (2011). Substation with zero auxiliary consumption. 9th World Congress on Railway Research. Lille, France, May 22-26, 2011.
- Wang, J. et al. (2015). Modeling on energy harvesting from a railway system using piezoelectric transducers. Smart Materials and Structures, 24, 5-17.
- Zhang, X. et al. (2016). A portable high-efficiency electromagnetic energy harvesting system using supercapacitors for renewable energy applications in railroads. Energy Conversion and Management, 118, 287-294.
- The Financial Express (2016). India's first solar-powered train: All you want to know about Indian Railways' green initiative. Available at: <http://www.financialexpress.com/economy/indias-first-solar-powered-train-all-you-want-to-know-about-indian-railways-green-initiative/264505/> (accessed 02/08/2016).
- Gifford, J. (2011). High-speed rail line installation powers first solar train. 07 June 2011 http://www.pv-magazine.com/news/details/beitrag/high-speed-rail-line-installation-powers-first-solar-train-_100003253/#axzz4Q4xzJbpL (accessed 15/11/2016).

Source: Eva Suárez.



2. Measures related to power traction

2.1. “Well-to-tank” losses

2.1.1. Generation and distribution

2.1.2. Electrification

2.1.1. Generation & distribution

Introduction

Efficiency

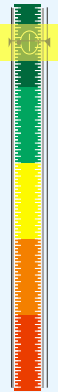

Increasing voltage on the power grid connections implies a reduction in energy losses, which goes hand in hand with a reduction in the amount of imported energy and a decrease of CO₂ emissions.

Investment

No data.

Scope of the measure

- ➔ The imported energy decreases due to the use of grids with higher voltage, which have fewer losses.
- ➔ The exported energy increases due to the possibility of returning the power to the grid and the possibility to reduce losses using a higher voltage grid.
- ➔ By using the more efficient well to tank primary energy, which in electric traction means the greater the voltage, the lower the losses, which implies a reduction of the CO₂ emissions.

Field of application

	Field 0	Field 1	Field 2	Field 3	Field 4	Field 5
Field of Application	Common measures to other sectors	Measures of train and track design	Efficient use of power traction	Optimization of operations	Use of the regenerated energy	Interaction between electricity networks
Generation and distribution						
		Design Measures		Redesign Measures		Operation Measures

Technology analysis

“Well to tank” (WTT) losses are energy losses that occur through the different processes of transformation and transport or distribution, from the primary energy source (represented by the wheel, “well”, from the oil well) to the vehicle supply which is represented by the “tank” of fuel. “Well to tank” losses are, therefore, the difference between “primary energy” and “final energy”. See figure 1, which shows the path of energy from extraction to use.

As shown in figure 2, in the case of diesel traction, “well to tank” losses are composed by the losses that take place in the extraction, refining, transportation, etc. and it is assumed that an equivalent yield between 81% and 88% (see table 1, which shows the losses in the fossil fuels extraction, transport and transformation). In electric traction losses generating electricity and distribution are included, and represent a performance of approximately 37% to 43% with the biggest losses in electricity generation.

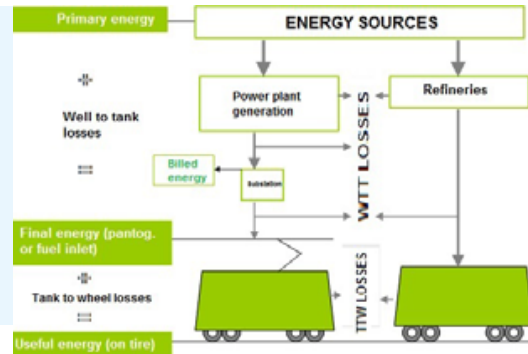

Figure 1. Primary, final and useful energy in operation. Source: García, A. (2016).

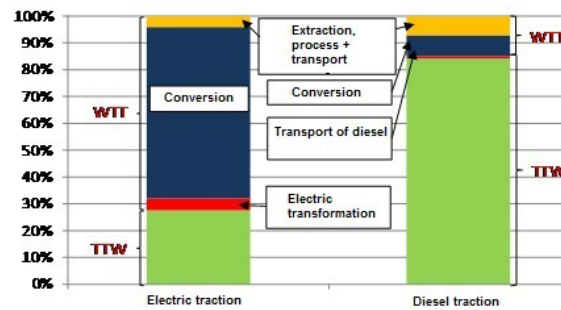

Figure 2. Percentage of energy by phases. Source: García, A. (2016).

	Gasoline	Diesel	Fuel oil	Kerosene	LPG	CNG pipeline	CNF from GNL
Extraction	0.029	0.029	0.029	0.025	0.026	0.013	0.02
Pipeline transport	0.003	0.003	0.003	0.003	—	0.028	—
Sea transport	0.008	0.008	0.008	0.007	0.054	—	0.09
Transformation	0.145	0.122	0.122	0.122	0.100	—	0.08
T&D in Spain	0.017	0.017	—	0.001	0.002	0.086	0.03
Total	0.204	0.179	0.159	0.161	0.182	0.128	0.22

Table 1. Well to tank losses. Source: García, A. (2016).

Moreover, for electric traction, energy losses and CO₂ emissions, before they reach the catenary, depend on the voltage level of the grid line electrification, as is shown in Table 2, where it is possible to see the losses in different voltage level grid connections in the national case.

	Connection voltage (kV)	Rate of losses in the transmission
2x25kV CA	400	101.20%
1x25kV CA	220	102.30%
3000V CC (suburban)	1<V<36	105.90%
3000V CC (others)	1<V<36	105.90%
1500V CC	1<V<36	105.90%
750V CC	1<V<36	105.90%
600V CC	36<V<72,5	105.90%

Table 2. Losses in different grids. Source: García, A. (2016).

Figure 3 shows the thermal power plant efficiency in some European countries in 2004.

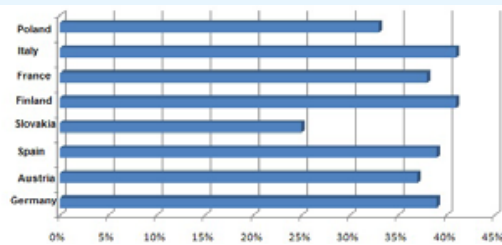

Figure 3. Thermal power plant efficiency. Source: García, A. (2016).

Objectives and benefits

One of the main objectives in order to increase the efficiency of the system is to reduce the “well to tank” losses, i.e. energy losses that occur in the different processes of transformation and transport from the primary energy source.

Losses depend on the primary energy used and the transformation, distribution and transport which are subdued, as it is possible to see in the following tables.

Table 3 shows the performance of the thermal power plants.

Year	Classic Thermal Power Plants	Combined Cycle Power Plants (*)	Diesel Power Plants	Other Thermal Power Plants
1998	34.2%	..	37.1%	38.2%
1999	34.7%	..	40.5%	35.4%
2000	34.8%	..	38.9%	31.9%
2001	34.6%	..	38.7%	31.8%
2002	35.1%	55.0%	38.8%	31.8%
2003	35.1%	55.0%	38.1%	30.6%
2004	35.6%	55.0%	37.8%	28.9%
2005	35.1%	55.0%	39.0%	32.7%
2006	34.8%	55.0%	37.7%	36.6%
2007	ND	ND	ND	ND
Last 10 years average	34.9%	55.0%	38.5%	33.1%

(*)Typical Value, assuming half load of 100%

Table 3. Performance of the national power plants. Source: García, A. (2016).

Table 4 shows the losses through the natural gas chain.

Types of distribution	Relative weight [%]	Losses coefficient
Liquefied Natural Gas	69.5%	122%
Pipeline Natural Gas	30.5%	113%
Total	100%	119%

Table 4. Losses through the natural gas chain Source: García, A. (2016).

Table 5 shows the chain losses of the petroleum products.

Fuel	Losses coefficient (*)
Gasoline	114%
Diesel	112%
Fuel oil	112%
Kerosene	112%
LPG	112%

(*) Transport losses have been despised

Table 5. Chain losses of the petroleum products. Source: García, A. (2016).

Table 6 shows the losses through the coal chain.

Fuel	Losses coefficient
Coal	107%

Table 6. Through the coal chain. Source: García, A. (2016).

As is shown in table 2 on the previous page, the higher the voltage, the lower the losses, and according to the kind of primary energy, the losses are lower or higher.

Applications

Experimental applications

Author	Explanation	Benefits
Pilo, E. et al.(2009)	The study carried out by Pilo, E. et al. (2009) describes the process of generation and transmission of electricity. It is analysed from the power station in which it is produced to the points where (vehicles and fixed installations of transport) is consumed.	Estimating emissions related to energy consumption, which is related to the technologies used in the generation and the benefits of each one of them.

Author	Explanation	Benefits
López, J. M. et al. (2008)	The purpose of this paper is to evaluate and quantify energy consumption and emissions of greenhouse gases in each of the stages of the energy chain of some petroleum products and natural gas, used in the field of transport.	Energy losses that occur in the petroleum chain processes are analysed.

Bibliography

- Pilo, E. et al.(2009). Flujos de la energía de la electricidad para el Transporte Electricity flows for transport. EnerTrans, monografía 9, Madrid (Spain).
- García, A. (2016). Energía y emisiones, Fundación de los Ferrocarriles Españoles, Madrid (Spain).
- López, J. M. et al. (2008). Flujos del petróleo y del gas natural para el transporte EnerTrans, monografía 8, Madrid (Spain).

2.1.2. Electrification

Introduction

Efficiency

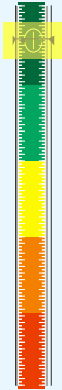

The efficiency of this measure is given essentially, by increasing the use of electric rolling stock, which implies a reduction in the use of diesel traction which has a higher impact on GHG and CO₂ emissions.

Investment

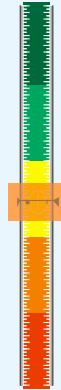

Typically, electrification requires a fixed initial investment (substations, transformers, switches, overhead contact line, etc.), and also an increase in the maintenance cost. The report “T633: Study on Further Electrification on the UK Railway” quoted a range of rates from £500k (587k€) to £650k (705k€) for electrification costs per single track kilometre.

Scope of the measure

- ➔ The exported energy increases due to the use of the regenerative brake.
- ➔ There is an increase of the use of renewable energy, as the energy can be supplied by renewable sources.
- ➔ There is a decrease of between 19% and 33% in CO₂ emissions, according to Network Rail, due to electrification.
- ➔ The electrification implies no local emissions.
- ➔ The energy cost is approximately half (between 50% and 60%) of the diesel energy cost.

Field of application

	Field 0	Field 1	Field 2	Field 3	Field 4	Field 5
Field of Application	Common measures to other sectors	Measures of train and track design	Efficient use of power traction	Optimization of operations	Use of the regenerated energy	Interaction between electricity networks
Electrification						
		Design Measures		Redesign Measures		Operation Measures

Technology analysis

According to UIC statistics, in 2014 approximately 50% of the total railway lines in Europe were electrified, as it is shown in the figure below. With the exception of countries such as Germany (60%), Spain (61%), Italy (74%), Belgium (82%) or Sweden (84%), with a high percentage of kilometres electrified over the total network, it is noted, that there is still scope for improvement, especially in countries such as the UK (32%) or Czech Rep. (34%).

According to UIC statistics, in Africa, approximately 18% of the total railway lines are electrified; in America, in Canada, UIC data set out that approximately 0,50%. Regarding Asia approximately 43% are electrified.

These data, which are presented in the map below, show that most of the global railway network is still not electrified.

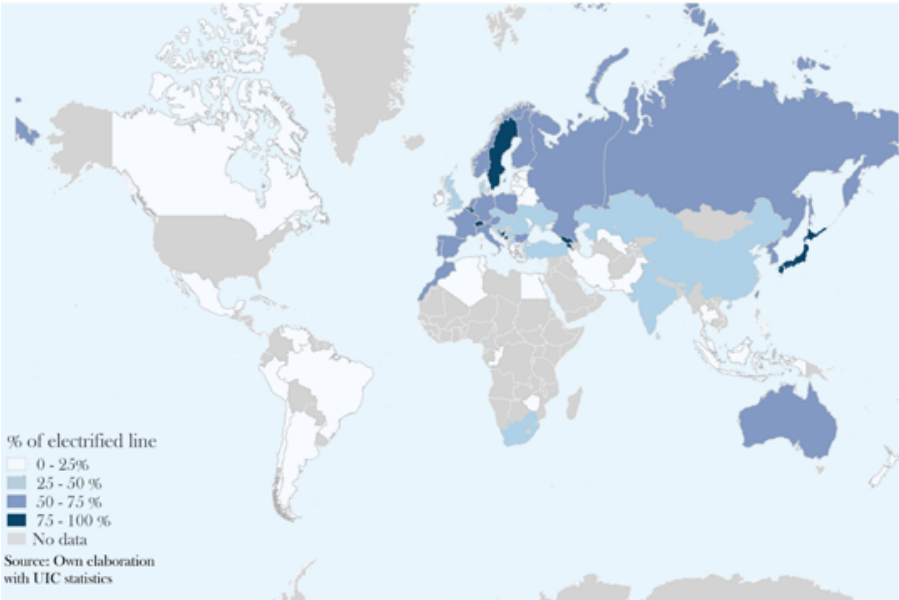

Figure 1. Percentage of electrification. Source: Own elaboration by UIC and CIA statistics 2016.

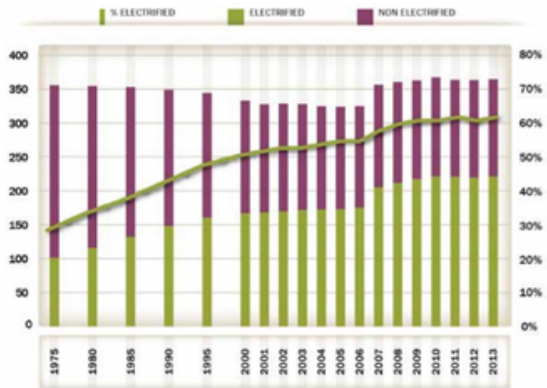

Figure 2 shows the length and share of electrified and non-electrified railway tracks, in Europe between 1975 and 2013 (thousand km).

Figure 2. Length and share of electrified and non-electrified railway tracks, 1975-2013 (thousand km). Source: Railway Hand Book 2016.

The following map (figure 3) shows the different types of electrification in Europe.

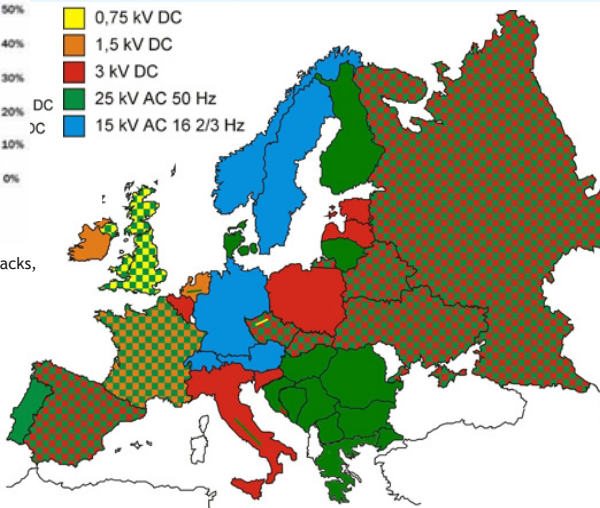

Figure 3. Types of electrification in Europe. Source: kolejpedia.

Objectives and benefits

The decision to electrify a line has historically been taken comparing the economic case for investment against the present net value of the operating cost savings generated by electrification. As it was mentioned in the introduction, electrification requires a fixed initial investment (substations and catenary), however it produces lower operating costs, as the economic cost of the energy consumed is lower in electric traction.

The profitability of electrification for a railway company is reached after a certain threshold of traffic. López Pita, A (2008) has described rigorously the classical calculation system, providing reference values. The graph-type shows the break-even point of electrifying a line according to the voltage level.

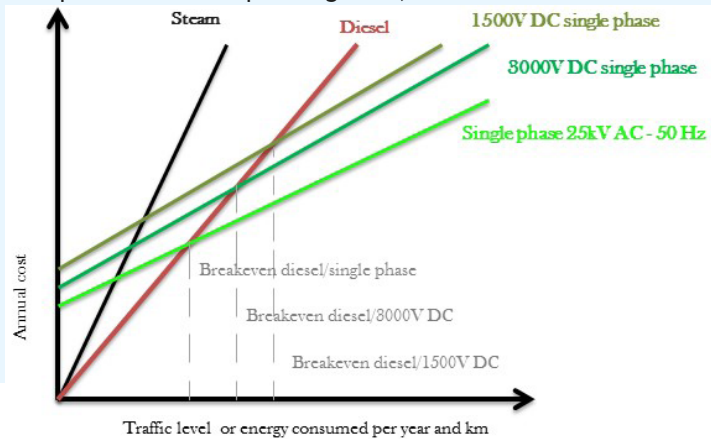

Figure 4. Costs comparison in different tractions. Source: Lopez Pita, A. (2008).

As it can be appreciated in Figure 4, electrification requires a fixed initial investment. However, the operational cost (variable cost which depends on traffic level) is lower in electrified lines than non-electrified lines. The higher the voltage, the lower the operational cost. According to that, Bombardier has carried out a study of the energy costs per train and per year for electric technology compared to diesel technology for single-decker (SD) and double-decker (DD) trains (see results in figure 5).

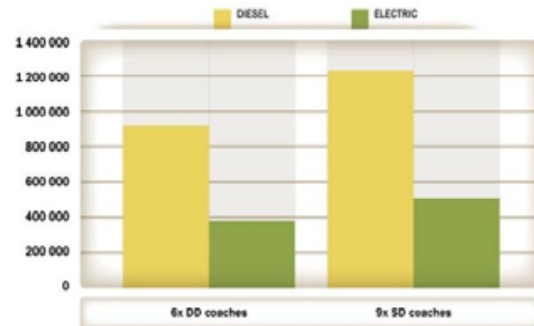

Figure 5. Energy cost per train and year in diesel in electric traction. Source: Railway Hand Book (2015).

As it is shown in the graph above, the energy cost is approximately half (between 50%- 60%) of the diesel energy cost.

Table 1 shows the results of the study made by the UK Network Rail (2009).

Study	Date/type	Diesel	Electric
Interfleet	interurban	24 g CO ₂ /seat.km	16 g CO ₂ /seat.km
Interfleet	inter-city	28 g CO ₂ /seat.km	18 g CO ₂ /seat.km
Atkins	2007	1305 g CO ₂ /veh.km	1034 g CO ₂ /veh.km
Atkins	2010 (RTFO)	1240 g CO ₂ /veh.km	1000 g CO ₂ /veh.km
Atkins	2020 (RTFO)	1240 g CO ₂ /veh.km	936 g CO ₂ /veh.km

Table 1. Result of the study. Source Network Rail (2009).

Applications

Experimental applications

Author	Explanation	Benefits
García Alvarez, A. (2016)	This publication studies the number of kilometres need to be electrified, in order to optimize the investment cost of electrification taking into account the reduction of CO ₂ emissions per tons-kilometre transported.	This publication sets out that on the Spanish network 10% of non-electrified lines induces more than 35% of the tons km transported with diesel traction; and electrifying 30% of the lines that are non-electrified involve eliminating 60% of diesel tons kilometre, which means avoiding 100 million kg of CO ₂ emissions.

Real applications. Demonstrators

Author	Explanation	Benefits
UK Network Rail (2009)	There has been a project plan since 2009 to electrify railways lines. Phase 1: Edinburgh to Glasgow. Phase 2: Electrification of the remaining routes in the Central Belt. Phase 3: Electrification of the routes between Edinburgh, Perth and Dundee including the Fife Circle. Phase 4: Electrification from Dunblane to Aberdeen.	This railway electrification will have the benefit of electrifying key parts of the network, in terms of both reducing its ongoing cost to the country and improving its environmental performance. The study on further electrification of Britain's railway network gives the results that are shown in the table that is on the previous page.

Author	Explanation	Benefits
L. Abrahamsson (Lulea University of Technology) S. Östlund (KTH Royal Institute of Technology)	These authors propose a high-voltage DC feeder as an alternative to widespread AC power supply systems in electric railways. A numerical model has been developed to evaluate the differences between both options.	Numerical results show that the proposed high-voltage DC feeder provides the same voltage to the catenary and reduces power losses with regards to conventional AC power supply.

Author	Explanation	Benefits
ADIF Renfe Spanish Ministry of Public Works	The first high-speed lines built in Spain (such as Madrid-Sevilla) where electrified with a 1x25 kV AC configuration. Newer lines (such as Madrid-Valencia) are built with a 2x25 kV configuration which consist of two conductors: the catenary and a return feeder placed along the track. The tension between the catenary and the rail is still 25 kV (and so trains are powered under the same conditions than with the 1x25 kV setting), but the tension between the catenary and the feeder is 50 kV.	The 2x25 kV is being used in France, Japan, Spain, Italy and Russia and is slowly becoming a standard in all countries where high-speed lines are fed with 25 kV AC. This configuration allows the current in the catenary to be smaller, hence causing lower power and tension losses. Moreover, as the major part of the current returns through the feeder instead of the rail, electromagnetic interferences to other systems are greatly reduced.

Author	Explanation	Benefits
The Salt River Project Navajo Generating Station	CZECH municipally owned infrastructure manager Železnice Desná (ŽD), which owns two branch lines totalling 22 km in Moravia, has completed a project electrify and modernising the 19 km Šumperk - Kouty nad Desnou line.	With the electrification of the line, passengers will benefit from faster journey times and "greener" transport with fewer emissions.

Bibliography

- Network Rail (2009) Network RUS electrification (UK). October 2009. London (UK). http://www.networkrail.co.uk/browse%20documents/rus%20documents/route%20utilisation%20strategies/network/working%20group%204%20-%20electrification%20strategy/networkrus_electrification.pdf (accessed 15/11/2016).
- García, A. (2016) Energía y emisiones en el transporte por ferrocarril (5th edition). Fundación de los ferrocarriles españoles. Madrid (Spain).
- Lopez, A. (1998). Pendulación, basculación y construcción de infraestructuras ferroviarias: Opciones alternativas y complementaria. Ministerio de Fomento, GIF y Colegio de ingenieros de Caminos, Canales y Puertos. Madrid (Spain).
- Atkins (2007). T633: Study on Further Electrification on the UK Railway (UK). RSSB Research and Development Programme. July 2007. London (UK).
- UIC (2016). Railway Handbook 2016. Energy Consumption and CO₂ emissions. Paris (France). Available at: http://uic.org/IMG/pdf/iea-uic_railway_handbook_2016_web.pdf
- UIC (2015). Railway Handbook 2015. Energy Consumption and CO₂ emissions. Paris (France). Available at: <http://uic.org/energy-and-co2-emissions> (accessed 27/07/2016). Paris (France).

2.2. “Tank-to-wheel” losses

- 2.2.1. Traction
- 2.2.2. Hybrid trains
- 2.2.3. Hydrogen fuel cell
- 2.2.4. Natural gas propulsion

2.2.1. Traction

Introduction

Efficiency

The efficiency of this technology is given by: (i) increasing the use of electric traction, which implies a reduction of the use of diesel traction with major losses on the traction chain and (ii) the use of more advanced technologies (i.e. AC asynchronous traction motor with IGBT inverters).

Investment

(i) The equipment to provide electric traction is simpler than that required for diesel traction and this is reflected in the capital cost.
 (ii) An increase in the performance of the traction motors due to a new technology implies an increase in the investment cost.

Scope of the measure

- ➔ The use of the electric traction in catenary powered operation reduces the amount of energy imported compared with the diesel traction. According to the studies analysed electric traction requires between 6,7% and 34,7% less primary energy.
- ➔ The use of electric traction in catenary powered operation implies a higher use of the regenerated energy, therefore there is an increase of the use of the energy exported.
- ➔ A higher use of the regenerative brake involves an increase in the use of the energy generated by renewable sources.
- ➔ Electric traction: Optimisation of traction software. The saving potential of such a measure raises energy efficiency by 1-3% depending on vehicle and degree of software optimisation already undertaken by the manufacturer.
- ➔ Diesel traction: Upgrading of existing engines. Direct injection technology improving the energy efficiency of diesel combustion engines by 15-20%. (EVENT report).

Field of application

	Field 0	Field 1	Field 2	Field 3	Field 4	Field 5
Field of Application	Common measures to other sectors	Measures of train and track design	Efficient use of power traction	Optimization of operations	Use of the regenerated energy	Interaction between electricity networks
Traction						
		Design Measures		Redesign Measures		Operation Measures

Technology analysis

The total energy required at the wheels is provided by the traction motors. These traction motors are fed with electricity from the catenary or with diesel fuel, which also implies differences in the components or equipment required, as it is shown in figure 1.

In addition, figure 2 and figure 3 show different schemes of the different elements that are necessary in electric traction with AC and DC respectively.

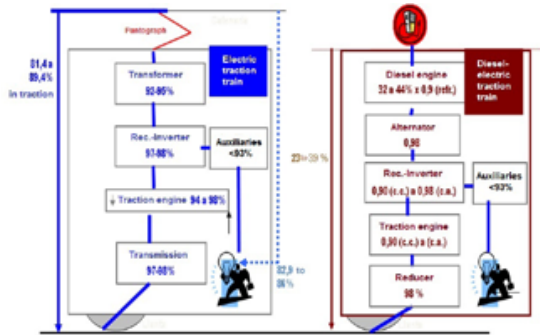

Figure 1. Tractor vehicles efficiency Source: García, A. (2016).

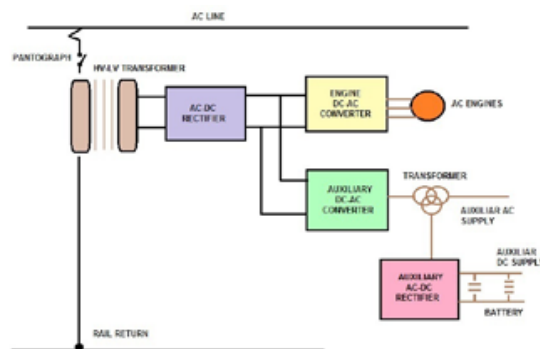

Figure 2. DC line power equipment. Source: own elaboration. (2016).

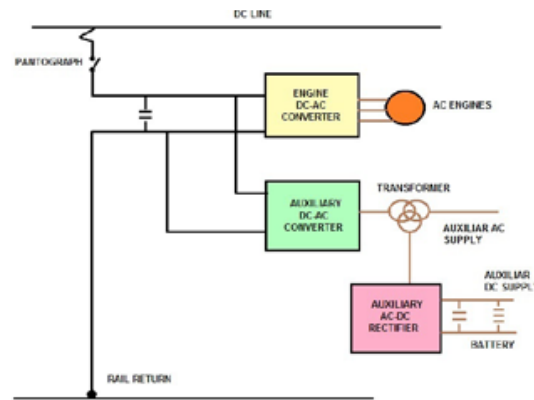

Figure 3. DC line power equipment. Source: own elaboration. (2016).

Taking into account the technology's differences in the traction motors, it is important to highlight that, the energy conversion from the entrance (the catenary or fuel tank) to the wheel gives rise to an additional energy consumption in the form of losses, mainly heat losses. Each of the involved components of the power train converts one form of energy into another, a process which involves a certain amount of heat losses; leaks that differ from one another depending on the technology. The following figures show the efficiency of the components of the electric and diesel chain traction.

A.C. 92% 2MW, 94% 3MW, 95% 4MW. D.C. NO (100%)				Transformer
GTO or IGTB				
D.C. (direct to line) 98% A.C. 97%				Converter
D.C. Engine 500 kW-91,5% 1000 kW- 92,5% 1500 kW-93,5%	A.C. Synchronous 500 kW-93% 1000 kW-94% 1500 kW- 94,5%	A.C. Asynchronous 94%	A.C. Permanent magnets 98%	
				Engine
2 stages 98%		3 stages 96,5 %		Reduction gear

Figure 4. Efficiency at different stages of the electric vehicle. Source: García, A. (2016).

32% to 44% (Variable)				Engine
Mechanic 95%	Hydraulic 82%	Electric		
		D.C. 0,98C	A.C. 0,985C	
		0,90Cx	0,96Cx	Transmission
		0,90M+	0,93M+	
		81%	90%	Reduction gear
98%				
Mechanical Total 29 to 40%	Hydraulic Total 36 to 35 %	D.C. Electric Total 25% to 28%	A.C. Electric Total a.c. 28% to 39%	

Figure 5. Efficiency at different stages of the electric vehicle. Source: García, A. (2016).

Objectives and benefits

The potential efficiency of traction technologies lie in:
 I) The use of electric traction, which implies a reduction in the use of diesel traction with major losses on the traction chain. As it was shown in the previous section, the overall efficiency for electric traction is around 85%, significantly higher than the overall efficiency for the diesel traction (around 40%), and this implies differences in the energy imported by the train. Table 1 shows the energy consumption and its differences according to the traction used for passengers and freight. Figure 6 shows the differences between primary and final energy according to the traction mode, and the motor.

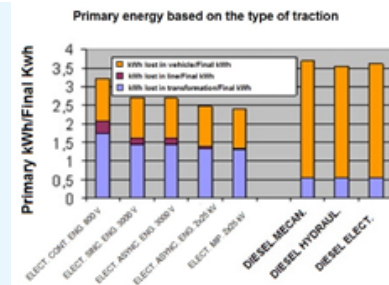

Figure 6. Comparison of primary energy for 1KWh of final energy. Source: García, A. (2016).

Traction		2005	2009
Electric traction	Passengers	1,524,428.84	1,484,008.00
	Freight	574,303.08	489,195.04
	Total	2,098,731.92	1,973,203.04
Diesel traction	Passengers	1,715,729.44	1,585,364.53
	Freight	1,900,815.86	1,645,694.80
	Total	3,616,545.30	3,231,059.33

Table 1. Energy consumption according to the traction. Source: Own elaboration by UIC data. (2016).

(*) Data collected from UIC statistics. Austria, Belgium, Bulgaria, Cyprus, Czech, Denmark, Estonia, Finland, France, Germany, Greece, Hungary, Ireland, Italy, Latvia, Lithuania, Luxembourg, Netherlands, Poland, Portugal, Romania, Slovak Rep, Slovenia, Spain, Sweden, UK.

II) The use of more advanced technologies. Regarding this point electric and diesel traction have to be treated separately:

1. Electric traction:

- Transformers. The heavier the transformer, the more efficient will be. In terms of efficiency, two breakthrough technologies can be highlighted: (i) the HTSC transformer which dramatically increases efficiency by using superconducting material, and (ii) the medium-frequency transformer which saves mass and losses by exploiting the fact that induction increases with frequency.

- Inverters. The main efficiency advances lie in power electronics. With IGBTs replacing GTOs,
- Traction motors:
 - Asynchronous traction motors, which can improve the efficiency due to their characteristics.
 - Wheel-mounted permanent magnet synchronous motor: in this the engine's gears and flexible couplings are not needed, which implies an increment in the transmission efficiency, and a reduction of noise, weight, volume and maintenance.
 - Transversal flux motor: consists of permanent magnets arranged in a ring-shape. The direction of the magnetic flux is perpendicular to the rotational vector. This way, the transversal flux construction principle allows a very high power density.
- Intelligent control algorithms for the individual traction components.

2. Diesel traction:

- In term of transmission technologies, it can be said that transmission also plays an important role due to the different efficiencies, depending on the technology used (see table 2).
- Replacement engines in diesel stock, and further developments in diesel technology will also contribute towards saving energy.
- Common Rail for diesel engines: this technology, based on a high pressure central deposit, means engines can reduce the noise, achieve a stronger performance, improve emission control and save fuel.
- Improve the injectors.

Study	Diesel-mechanic	Diesel-etric	Diesel-hydraulic
Engine efficiency	equal	equal	equal
Transmission efficiency	=95%	=85%	=85%
Possibility for optimum engine load	high	high	low
Potential for recuperation	low	high	-

Table 2. Comparison of transmission system in diesel traction. Source: DSB.

Applications

Experimental applications

Author	Explanation	Benefits
Network Rail	The Network RUS is a report which studies the benefits, cost, maintenance cost, the environmental effects of the electrification in UK railways. It has been made to value whether or not electrification is profitable. But also it studies the differences in costs between electric and diesel traction	The data estimate the operating costs of diesel and electric passenger rolling stock. Cost per mile are significantly lower for electric vehicle e.g. fuel cost per mile is 47 pence for diesel vehicle and 26 pence for electric vehicle.

Real applications. Demonstrators

Author	Explanation	Benefits
Alstom	Permanent magnet engine is powered by a drive system consisting of Onix 6.5 kV IGBTs power modules, a 3600 V power bar and the innovative permanent magnet motors (PMM) by Alstom. These engines are reduced weight and improve energy efficiency. They have an improved power/weight ratio of 1 kW/kg.	A lower power consumption which represents a 15% less of energy consumption and a 97% of efficiency.

Bibliography

- García, A (2016). Energía y emisiones en el transporte por ferrocarril (5th edition). Fundación de los ferrocarriles españoles, Madrid (Spain).
- Rodriguez, A. (2008). Alstom presenta su nuevo tren de alta velocidad, AGV a 360 km/h. Vía libre magazine, nº 453, 4-8.
- Olea, F. J. (2010). Rendimientos de la cadena de tracción eléctrica. ElecRail Monografía ElecRail Nº 2. Madrid (Spain).
- UIC (2003). Energy Efficiency Technologies for Railways.
- Network RUS electrification (October 2009), (UK).
- Deutsche Bahn AG, Railway Environment Centre (2003). Evaluation of Energy Efficiency Technologies for Rolling Stock and Train Operation of Railways, UIC, March 2003 Berlin (Germany).

2.2.2. Hybrid trains

Introduction

Efficiency

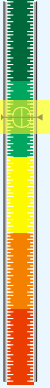

Hybrid trains add greater versatility in terms of operational procedures. The use of this type of rolling stock involves a reduction in the use of diesel power traction.

Investment

No data.

Scope of the measure

- ➔ The amount of energy imported is reduced due to the use of the regenerative brake.
- ➔ The exported energy increases due to the possibility of returning power to the grid.
- ➔ There is an increase of renewable energy use due to the possibility of the using electric traction and regenerative brake.
- ➔ By using electric traction and braking energy there is a reduction of CO₂ emissions.
- ➔ Hybrid trains have less local emissions than the diesel trains.

Field of application

	Field 0	Field 1	Field 2	Field 3	Field 4	Field 5
Field of Application	Common measures to other sectors	Measures of train and track design	Efficient use of power traction	Optimization of operations	Use of the regenerated energy	Interaction between electricity networks
Hybrid trains						
		Design Measures		Redesign Measures		Operation Measures

Technology analysis

The hybrid technology trains have both diesel and electric traction. This allows the use of a single rolling stock on lines with non-electrified sections reducing the number of kilometres running with diesel traction.

The hybrid electric locomotive (also called diesel-electric) is basically made of two main components: (I) a diesel engine which drives an electric generator, and (II) several electric motors (known as traction engines) that are connected to the wheels. Usually, there is an electric motor for each axle, being generally 4 or 6 in a typical locomotive. Figure 1 shows the difference between the components of a conventional diesel-powered train and a diesel-electric train.

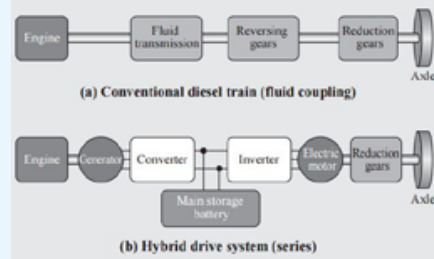

Figure 1: Traction System for Non-electrified Railway Lines. Diesel and hybrid trains components. Source: Shimada, M. et al. (2012).

Hybrid trains can be powered by one or two synchronous diesel generators supplying electricity to the electric engines of the train, then through pinions, they move the axes where the wheels are coupled. Power generators are connected in turn to power converters that adapt the frequency to the train's needs. After conversion, electricity is supplied to the electric motors of the train. Finally, the motors are connected by a gearbox to the drive shafts. Therefore, energy consumption is obtained by the efficiency of the gearbox, electric motor, power converters, generators and diesel engine finally to determine energy consumption (a generic diagram of the element of a hybrid train is provided in figure 1).

Regarding the performance of hybrid trains, when supplied by electricity, they work like an electric traction train, as shown in figure 2.

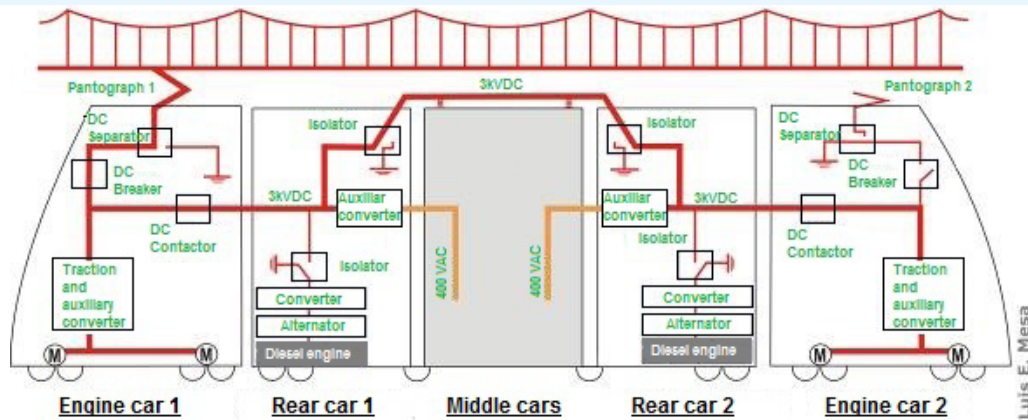

Figure 2. Dual passenger train supplied by electricity. Source: Gonzalez Franco, I et al. (2010).

Figure 3 displays graphically the operating systems of a hybrid train in diesel traction mode.

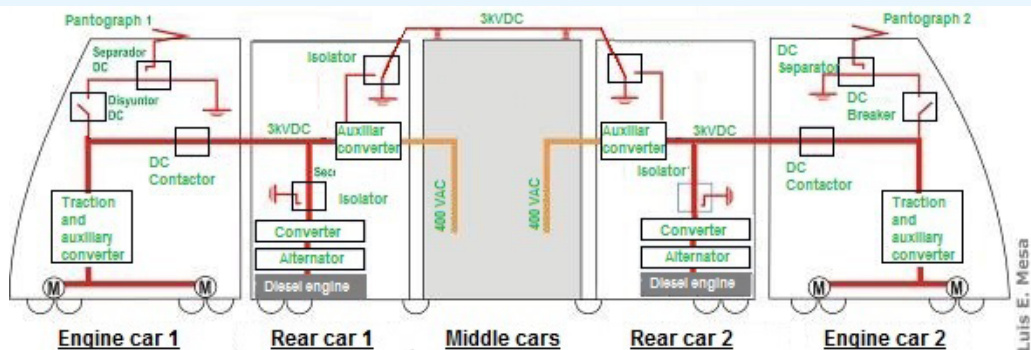

Figure 3. Dual passenger train supplied by diesel. Source: Gonzalez Franco, I et al. (2010).

Objectives and benefits

Basically, one of the goals of this type of train is to reduce the number of kilometres that are driven with diesel traction on a partially electrified line, which would implement the efficiency due to the difference in the chain traction losses as explained in datasheet 2.1.1. and 2.2.1.

It is important to note that the efficiency of these trains is not always and in all cases greater than trains with diesel technologies, but depends on the number of electrified kilometres in the line. According to a study made by Gonzalez, I. (2010), the sweet spot, from which CO₂ emissions begin to be lower using hybrid trains instead of diesel trains, is when the line is electrified about 30%, in case of passenger transport.

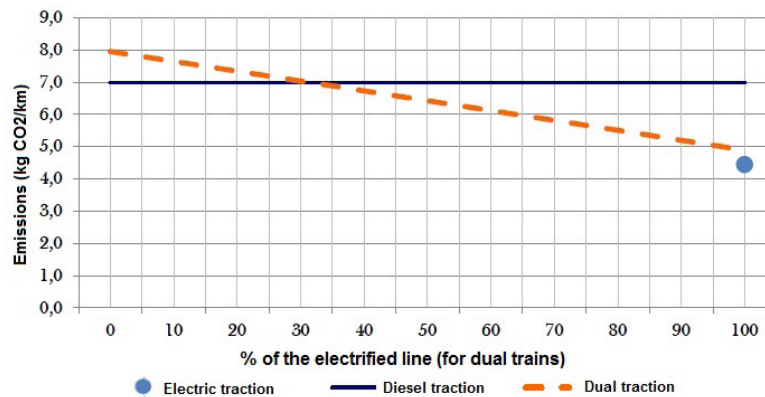

Figure 4. CO₂ emissions according to the electrified length in passenger transport. Source: Gonzalez Franco, I et al. (2010).

In case of freight transport, the hybrid traction for any percentage of electrification of the line has lower emissions than diesel (see figure 5). Although the masses of both compositions are similar, lower consumption and emissions are explained by the better performance of the hybrid traction locomotive (diesel electric transmission AC).

Consequently, the use of the hybrid machine (whatever the percentage of electrified line) is favourable with respect to the use of diesel machine along the whole journey.

Reducing emissions in dual traction is practically linear, so as the percent of electrified length increases, the advantage of using hybrid from diesel grows.

For a total electrified route, the emissions of hybrid locomotive are practically equal to those of an electric traction, if the hybrid has regenerative brake.

If the electrical locomotive has not got regenerative brake, dual trains produce less emissions even with a 10% travel in diesel traction, due to the regenerative brake hybrid locomotives have.

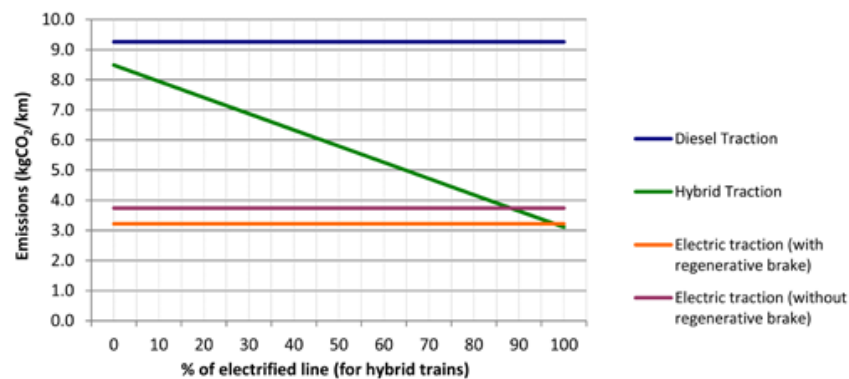

Figure 5. CO₂ emissions according to the electrified length in freight transport. Source: Gonzalez Franco, I et al. (2010).

Applications

Experimental applications

Author	Explanation	Benefits
Gonzalez, I. (2010)	This paper study the energy consumption and emissions of a train with electric, diesel, and dual traction. The same line has been used for the simulations in order to have the most homogeneous sample as possible.	Figure 4 show part of the results obtained by the author

Real applications. Demonstrators

Author	Explanation	Benefits
NEWAG S.A.	The company has hybrid vehicles with three-unit electric multiple unit powered by a 3 kV DC classic power system from the overhead line as well as a power module connected with a Scharfenberg coupler.	The vehicle is equipped with an electric power system and a control system optimizing energy consumption, a power recuperating module and storage system.

Author	Explanation	Benefits
Renfe, Spain	Fifteen trains are being transformed into dual. The transformation process is based on uncoupling the end from the trains cars, which are replaced by the newly installed ends vans carrying diesel traction equipment and existing old converters.	The train can travel on all electrified and non-electrified lines of ADIF, given its characteristics of strength, variable width and dual-current.

Bibliography

- García, A. et al. (2008). Análisis sistemático del consumo energético en líneas ferroviarias metropolitanas, de cercanías y de alta velocidad, con valoración del impacto energético y del resultado económico, incluyendo el desarrollo y contraste de modelos y simuladores parametrizables (ELECRAIL). Fundación de los Ferrocarriles Españoles, Madrid (Spain).
- Metro de Madrid (2012). Plan de ahorro energético. Madrid (Spain).
- Comboios de Portugal (2014). Relatório de Sustentabilidade (Portugal).
- Xin Yang, et al. (2015). An energy-efficient scheduling approach to improve the utilization of regenerative energy for metro systems.
- NEWAG S.A. (2016). “The first worldwide family of autonomous, configurable bi-modal rail vehicles for servicing cross-region, regional and urban passenger transport compliant with Technical Specifications of Interoperability TSI.”, (UK).
- Gonzalez, I. et al. (2010) Análisis comparativo del consumo de energía y emisiones de trenes eléctricos, diésel y duales. Fundación de los Ferrocarriles Españoles. Madrid (Spain).
- García, A. (2016) Energía y emisiones en el transporte por ferrocarril (5th edition). Madrid, Fundación de los ferrocarriles españoles, Madrid (Spain).
- Shimada, M. et al. (2015). Energy-saving Technology for Railway Traction Systems Using Onboard Storage Batteries Hitachi Review Vol. 61 (2012), No. 7 312- 318. Japan.

2.2.3. Hydrogen fuel cells

Introduction

Efficiency

Hydrogen fuel cells is one of the most promising alternatives for diesel traction (diesel technology has problems such as low energy efficiency, CO₂ and NO_x emissions, heavy noise and vibration). Fuel cells operate with almost no harmful emissions. Emissions are virtually zero. According to the test tackled by Ogawa, K. et al (2006) the energy efficiency of the traction chain can reach 50%.

Investment

According to recent studies a 300 kW fuel cell system costs 1.5 million

Scope of the technology

- ➔ The electricity's production is directly generated by chemical energy.
- ➔ It has high energy density and quick recharging.
- ➔ The machine is simple and silent.
- ➔ The system has long life cycle and high reliability.
- ➔ Is an almost zero emissions system.
- ➔ The hydrogen fuel cell has an increase in efficiency compared to diesel traction. Fuel cells energy efficiency has a value of about 52,70%.

Field of application

	Field 0	Field 1	Field 2	Field 3	Field 4	Field 5
Field of Application	Common measures to other sectors	Measures of train and track design	Efficient use of power traction	Optimization of operations	Use of the regenerated energy	Interaction between electricity networks
Hydrogen fuel cells						
		Design Measures		Redesign Measures		Operation Measures

Technology analysis

Fuel cells utilize hydrogen and oxygen from the air to create electricity through a chemical process. The fuel cells have three parts: anode, electrolyte and cathode (see Figure 1).

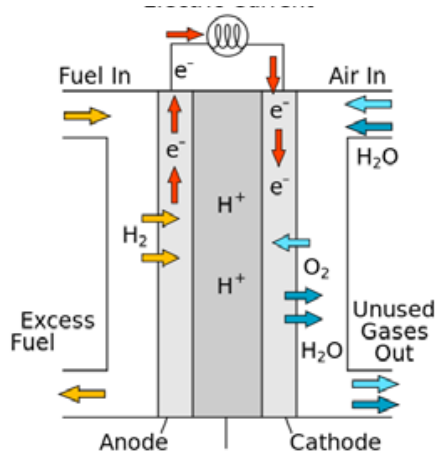

Figure 1. Fuel cell scheme. Source: Wikipedia (2012).

In the fuel cell, a membrane covered by platinum is sandwiched between two electrodes, the hydrogen is fed to the anode (negative electrode) and, oxygen is fed to the cathode (positive electrode).

The hydrogen comes into contact with the platinum catalyst. Then, the hydrogen releases electron (e^-) and changes into hydrogen ion (proton H^+). The membrane can transmit the hydrogen ion but cannot transmit the electron; the electron is lead to external loads through the anode. Finally, the hydrogen ion passes through the membrane to the cathode. Then, hydrogen ion, electron from the external loads and oxygen are combined to become water. Consequently, current flows can be used as a power supply.

The differences between the equipment that is needed in diesel-electric drive system and in a hydrogen drive systems is shown in figure 2 and 3 respectively.

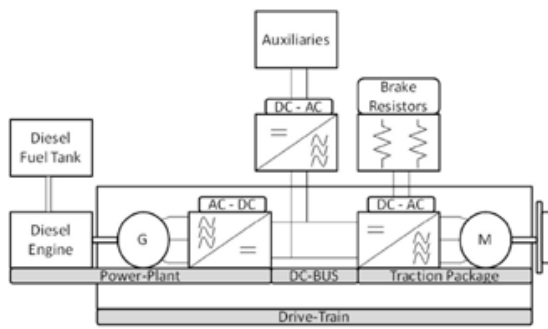

Figure 2. Diesel-electric drive system. Source: Hoffrichter, A (2013).

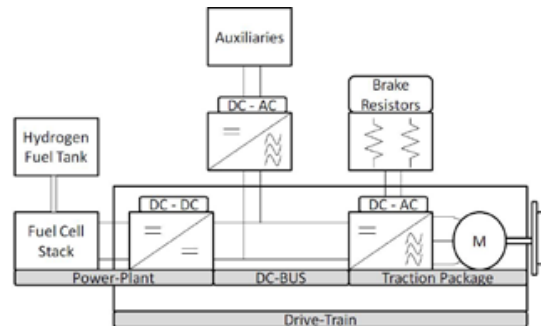

Figure 3. Hydrogen drive system. Source: Hoffrichter, A (2013).

Fuel cells technology required limited space of installation especially for mobile loads, as trains. Below some actual examples of how is the layout of a train equipped with fuel cells is shown.

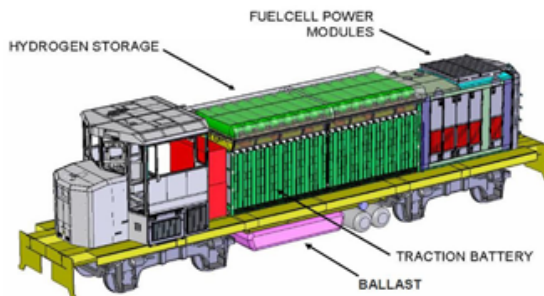

Figure 4. Hydrogen fuel cell CAD model Source: Miller, A. R. (2007).

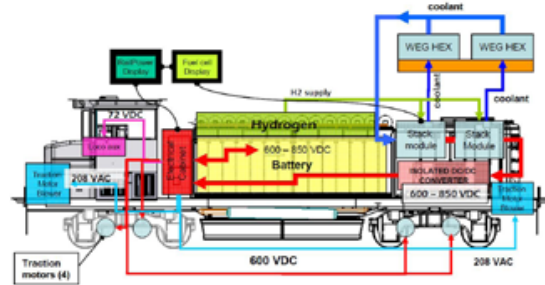

Figure 5. Hydrogen switcher's diagram. Source: Miller, A. R. (2007).

Objectives

The objective is to have cost-efficient low emission, low noise trains, running and avoiding the electric traction infrastructure and the diesel traction emissions. It can be asserted that fuel cells are clean power source.

Unlike diesel vehicles, fuel cells generate electricity through a chemical process without explosion (as hydrogen and oxygen can be combined to produce electrical energy and water without contamination), noise and vibration. The railway vehicles powered by fuel cells have lower carbon dioxide emissions and lower energy consumption due to high-efficiency of fuel cells.

Ogawa, K. et al (2006) study, analyses theoretically and experimentally the efficiency of fuel cell technology implemented in a real railway vehicle. This study underlined that, fuel cells energy efficiency was high, with a value of about 52,70%.

The advance of energy efficiency and fuel consumption of a simulation are shown in the following tables, in which the advance of 24% in energy efficiency and 30% in fuel consumption by the use of regenerative energy is pointed out.

Table 1 Fuel cell energy efficiency in each running condition.

Running condition	Test track	Rolling stock test plant
FC Energy efficiency (use only FC) (%)	49.90	52.70
Regenerative energy calculated from kinetic energy (kWh)	0.47	3.07
Energy efficiency utilizing regenerative energy (%)	65.20	64.90

Table 1: Fuel cell energy efficiency in each running condition. Source: Ogawa, K. et al (2006).

Table 2 Energy efficiency advancement in case of utilizing regenerative energy.

Running condition	Test track	Rolling stock test plant
FC output energy (kWh)	1.38	13.30
Electric energy obtained from consumed hydrogen (kWh)	2.77	25.30
Energy efficiency (%)	49.90	52.70

Table 2 Energy efficiency advancement in case of utilizing regenerative energy. Source: Ogawa, K. et al (2006).

Table 3 Energy efficiency in each running condition.

	Case 1	Case 2
FC output energy (kWh)	41.25	27.85
Regenerative energy (kWh)	-	14.81
Electric energy obtained from consumed hydrogen (kWh)	80.50	56.30
Energy efficiency (%)	51.30	75.70

Table 3 Energy efficiency in each running condition. Source: Ogawa, K. et al (2006).

Applications

Real applications. Demonstrators

Author	Explanation	Benefits
UK, Institution of Mechanical Engineers	UK's first hydrogen-powered locomotive, with 260 mm gauge, which used a 1-1 kW proton exchange membrane fuel cell to charge four lead acid batteries, along with regenerative braking. The batteries can drive two DC permanent magnet engines, providing enough tractive effort for the 320 kg locomotive to transport 4 tonnes.	It demonstrates that hydrogen is a viable alternative to fossil fuels for rail applications.

Author	Explanation	Benefits
Qingdao, China tram	An 8.8 km of tram line, with 12 stops between Qianwangtuan and Chengyang Wholesale Market. Part of the route has been fitted with 750 V DC overhead electrification, but elsewhere the trams are powered by hydrogen fuel cells.	Hydrogen fuel cell is a zero emission system and cost less than electric traction. Moreover, the fuel tank can be recharged in around 3 min.

Author	Explanation	Benefits
Alstom	Coradia iLint is based on the service proven diesel train Coradia Lint 54. Replacing the diesel traction by the fuel cell technology enables sustainable train operation while its performance matches that of regular regional trains.	Coradia iLint is a full emission-free train solution using Hydrogen as the ideal alternative energy source. Powered by fuel cells, its only emission is steam and condensed water while it operates with low noise level. It cover all safety-relevant aspects. Moreover, The installed traction system facilitates reduced energy consumption thanks to the energy storage and the intelligent energy management.

Bibliography

- Huria T. (2010). Rail Traction: The economics of transiting towards Hybrid & Hydrail. Sixth international hydrail conference, Turkey.
- Christou, A. G. Hydrogen Fuel Cell Power System Performance of Plug Power GenCore 5B48 Unit.
- Robles, A. (2015). Jornada Técnica de la PTFE: gestión energética sostenible e inteligente en el ámbito ferroviario. Madrid (Spain).
- Miller, A. R. et al. (2007). Zero-Emission, Hydrogen-Fuelcell Locomotive for Urban Rail. Vehicle Projects LLC, Denver, USA.
- TECH Institute (2016). Fuel cell and Hydrogen Technology.
- Hoffrichter, A. (2013). Hydrogen for railway traction. University of Birmingham (UK).
- Weirong CHEN (2013). System Integration of China's First Hydrail Locomotive. The Eighth International Hydrail Conference. Ryerson University - Centre for Urban Energy, Toronto, Canada , 2013.06.11-12.
- Ogawa, K. et al. (2006). Energy efficiency and fuel consumption of fuel cells powered test railway vehicle. Railway Technical Research Institute, Tokyo, Japan.

2.2.4. Natural gas propulsion

Introduction

Efficiency

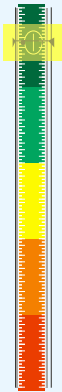

The efficiency of this technology (gas propulsion CNG, LNG, ANG) is given by using a less pollutant fuel. According to the studies analysed this new fuel can reduce approximately 70% of NO_x and 30% of CO₂ compared to diesel fuel.

Investment

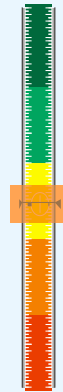

The initial investment is approximately 25% higher than diesel traction technologies. However, 200.000 €/year/loco. could be saved with natural gas-fuelled locomotive.

Scope of the technology

- ➔ This type of fuel has safe storage, transportation and use.
- ➔ LNG has approximately 70% of NO_x and 30% of CO₂ less emissions compared with diesel fuel.
- ➔ Around 200.000€/year/locomotive could be saved with natural gas-fuelled locomotive compared with diesel.
- ➔ By the use of less pollutant fuel there is a reduction of CO₂.
- ➔ The use of the less emitting fuel implies reduction of approximately the 80% of local emissions.
- ➔ Engines that work with LNG as a fuel have lower acoustic impact than engines which work with diesel.

Field of application

	Field 0	Field 1	Field 2	Field 3	Field 4	Field 5
Field of Application	Common measures to other sectors	Measures of train and track design	Efficient use of power traction	Optimization of operations	Use of the regenerated energy	Interaction between electricity networks
Natural gas propulsion						
		Design Measures		Redesign Measures		Operation Measures

Technology analysis

Natural gas propulsion is another alternative to diesel traction. Since the energy density of natural gas is low compared to diesel, the fuel has to be compressed (CNG), Liquefied (LNG) or adsorbed (ANG).

Liquefied natural gas (LNG) is a natural gas, predominantly methane, CH₄, that has been cooled to -162°C to reduce the volume in approximately 600 times and has been converted into liquid form to make easier the storage and transport. It is odourless, colourless, non-toxic and non-corrosive. The liquefaction process implies removing certain components, such as dust, acid gases, helium, water, and heavy hydrocarbons.

Using LNG as a combustible is similar to using diesel but with the advantages of the reduction of CO₂ emissions and cost.

LNG has been used as fuel for decades and nowadays is trying to jut out in railway systems as a substitute of the diesel fuel. The pictures show the amount of natural gas that is available in all over the world.

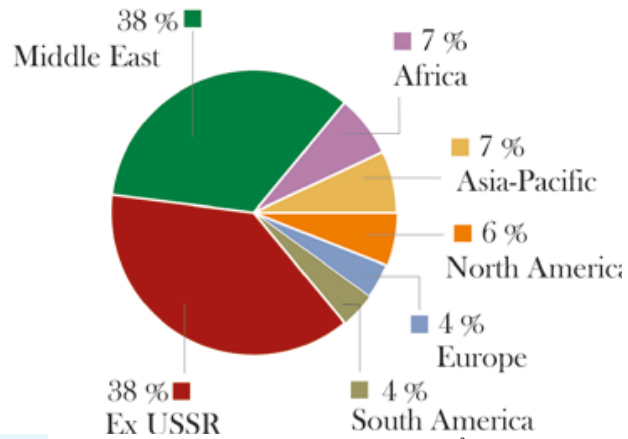

Figure 1: Natural gas world reserves 1998 (trillion m³). Source: BP Statistical Review of World Energy 1999.

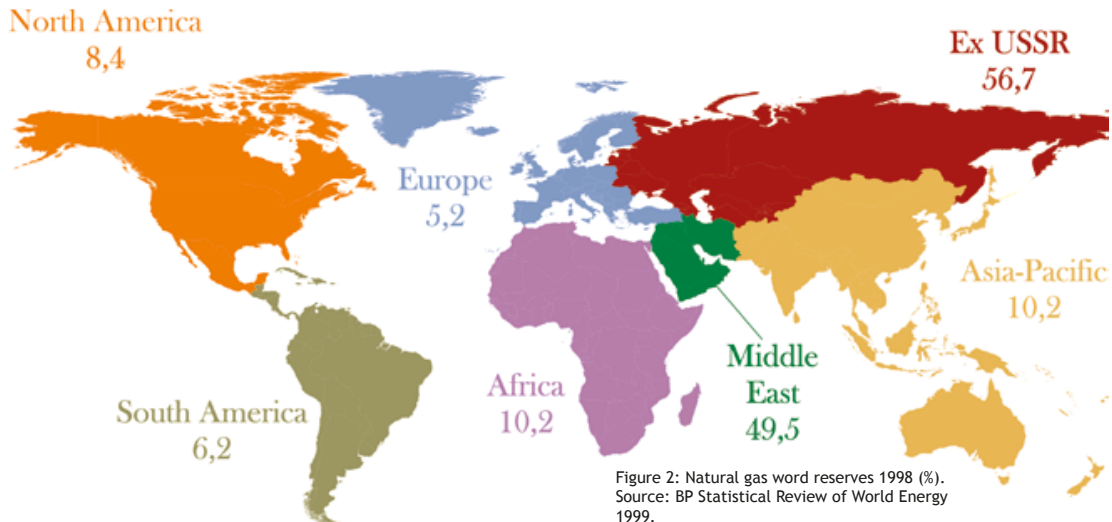

Figure 2: Natural gas world reserves 1998 (%). Source: BP Statistical Review of World Energy 1999.

Furthermore, natural gas propulsion is an attractive alternative due to its cost. Diesel prices in Europe remain considerably higher than natural gas (see Figure 3). The cost of natural gas (LNG) is not contingent on the volatility of crude oil prices.

The graph below shows the Gulf Coast ULSD price over the past five years as well as the LNG cost in based on Henry Hub NYMEX natural gas prices.

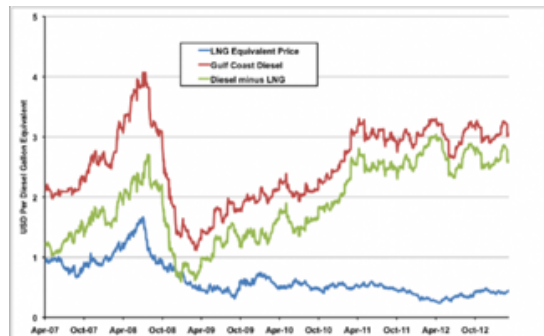

Figure 3. Gulf Coast Diesel and LNG equivalent price. Source: Fielden, S. (2013)

Objectives and benefits

According to a study made by the EIA (Energy Information Administration), liquefied natural gas (LNG) will play an increasing role in powering freight locomotives in coming years, as shown in the graph below.

The use of this fuel (natural gas) considerably reduces the CO₂ emissions and gases that are harmful for human health (see figure 5 and table 2).

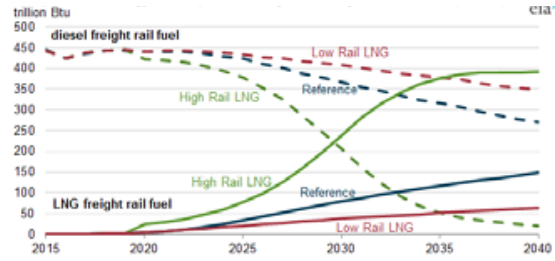

Figure 4. Comparison of energy consumption for freight rail using diesel and LNG (2015-40). Source: N. Chase(2014).

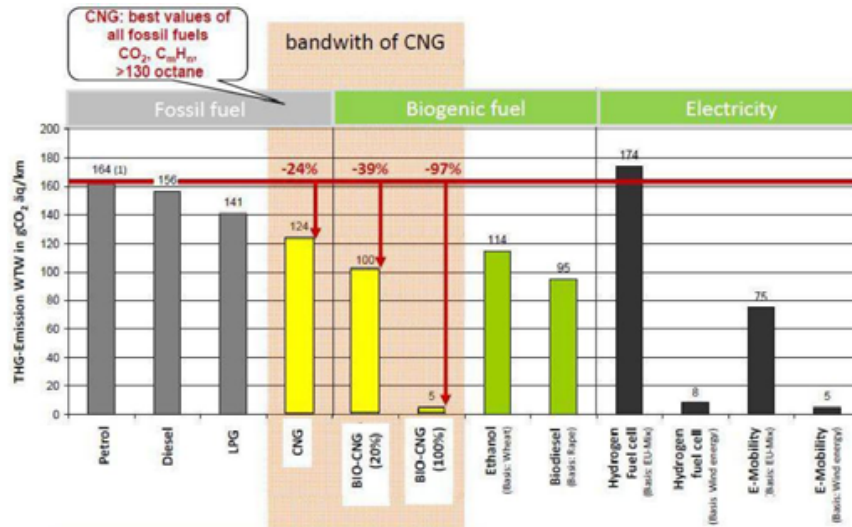

Figure 5. Comparison of energy consumption for freight rail using different combustibles. Source: Lage, M (2015).

Table 1 compares the differences between LNG locomotive and two similar diesel-electric locomotives that are working in the same route in the Pacific Harbor Line in Los Angeles.

Locomotive Type	Fuel	NOx	CO	THC	PM
MK 1200 LNG	LNG	1.40	2.20	3.30	0.09
Baseline Diesel	Diesel	17.60	1.83	0.87	0.38
Tier 2 Diesel	Diesel	7.30	1.83	0.52	0.21

Table 1. Differences in terms of emissions between LNG locomotive and two similar diesel-electric Source: P. Couch (2010).

Table 2 compares the differences between LNG locomotive to diesel locomotive in terms of power output, efficiency and emissions.

Fuel	Power (hp)	Efficiency	NOx (g/hp-hr)	CH ⁶⁶ (g/hp-hr)
LNG	4,141.00	0.42	7.30	1.16
Diesel	4,112.00	0.43	14.10	0.34

Table 2. Differences between LNG locomotive to diesel locomotive. Source: Union Pacific Rail Road (2007).

Applications

Real applications. Demonstrators

Author	Explanation	Benefits
Renfe, Spain	The pilot has been developed on passenger traffic between Asturias and Leon. It will enable RENFE to assess the technical and economic feasibility of using LNG powered service on rail passenger transport. The process has two phases: - The first one is the integration of a LNG drive system for a railway vehicle. - The second is a dynamic test on a line of low Traffic.	The benefits are the reduction in fuel cost and green house emissions. Moreover, there is another benefit due to fact that on the Iberian peninsula there is a high availability of LNG, and a large fleet of tankers that could transport it throughout it.

Author	Explanation	Benefits
Union Pacific Railroad Company	Union Pacific Railroad Company develop a LNG locomotive demonstration, the study shows a comparison between the old EMD SW1200 Switcher locomotive (1957), the new Motive Power MP20B Switcher (2008) and the MK1200G Switcher (LNG Test locomotive 1994).	Compared with the baseline and Tier 2 locomotives, the emissions from the LNG locomotive is 92%-81% lower in NOx and 76%-57% lower in particles. Notwithstanding the higher fuel consumption, LNG locomotives fuel cost is approximately 23% less compared to diesel fuel.

Author	Explanation	Benefits
Russian Railways' (RZD)	As part of its energy strategy, which is seeking alternatives to diesel power for non-electrified lines Russian Railways' (RZD) developed the TEM19 LNG locomotive.	The use of natural gas power has the potential to reduce operating and life-cycle costs as well as making rail transport more environmentally-friendly.

Bibliography

- Couch, P. et al. (2010). Demonstration of a Liquid Natural Gas Fuelled Switcher Locomotive at Pacific Harbor Line. California (USA).
- Robles, A. (2015). Ensayos-Piloto en Líneas no electrificadas: H₂ y GNL, Jornada Técnica de la PTFE: gestión energética sostenible e inteligente en el ámbito ferroviario. Madrid (Spain).
- Chase, N. (2014). Liquefied natural gas shows potential as a freight locomotive fuel. EIA USA International rail journal. April 14, 2014 (USA).
- Lage, M (2015). El gas natural, nuestra gran oportunidad. La alternativa real para la movilidad. Gasnam. Valladolid (Spain).
- Union Pacific Railroad Company et al. (2007). An Evaluation of Natural Gas-fuelled Locomotives. Los Angeles (USA).
- Fielden, S. (2013). Methane Train Running - Big Savings From LNG Locomotives.
- Innergy web
- RZD introduces locomotives running on compressed natural gas. December 19, 2014. Available at: <http://www.railwaypro.com/wp/rzd-introduces-locomotives-running-on-compressed-natural-gas/> (accessed 11/11/2016).

2.3. Other measures

2.3.1. Regenerative brake

2.3.2. Reversible substations

2.3.3. Neutral zones

2.3.1. Regenerative brake

Introduction

Efficiency

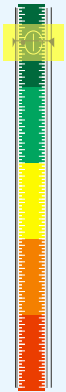

The efficiency of this technology (regenerative brake) is given by increasing the use of the kinetic energy. This energy is transmitted “backwards” and can be used by other trains or can be returned to the power grid.

Investment

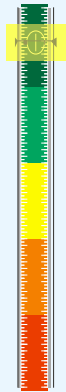

Regenerative brake does not require a high initial implementation cost for new rolling stock. On the other hand, the necessary investment to renew whole fleets of rolling stock with regenerative brakes cannot be in all cases cost effective.

Scope of the measure

- ➔ The exported energy increases due to the possibility of returning the energy to the grid.
- ➔ There is an increase of renewable energy use due to the braking energy can be used.
- ➔ By the use of the braking energy there is a reduction of the CO₂ emissions.
- ➔ The amount of energy imported is reduced due to the use of regenerative brake. There is a reduction of approximately 30% of the energy consumption.

Field of application

	Field 0	Field 1	Field 2	Field 3	Field 4	Field 5
Field of Application	Common measures to other sectors	Measures of train and track design	Efficient use of power traction	Optimization of operations	Use of the regenerated energy	Interaction between electricity networks
Regenerative brake						
		Design Measures		Redesign Measures		Operation Measures

Technology analysis

In electric traction trains, when braking, the kinetic and potential energy can be converted into electrical energy by using the motor as a generator (see figure 1).

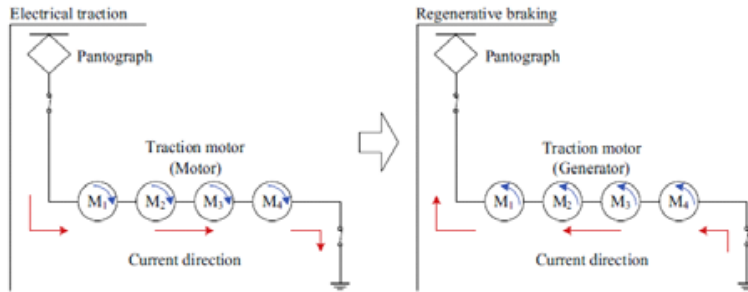

Figure 1. Principle of regenerative braking. Source: Xin Yang, et al (2015).

The electric energy generated when braking, cannot be stored in the train (except in those cases which the rolling stock is equipped with energy storage systems for feeding the batteries). Thus, if the rolling stock is equipped with regenerative brake, first of all, it tries to take

advantage of the energy for supplying the ancillary systems. If the ancillary systems require less energy than the amount generated in the braking process, the system tries to send back the “surplus” to the catenary. In case that the catenary “accepts”, this energy can be used, first, for feeding other trains, and if there is some energy that can not be used by other trains, it can be fed back into the public grid through the reversible substations.

In case of DC electrification, the energy returned to the catenary, commonly, cannot be fed back into the public grid, consequently the system only analyses if the energy is needed by other train within the same electrical section. If it is not used by other train the energy is lost by heating in the rheostat brake, figure 2 details the decision-making process followed by the energy generated in braking.

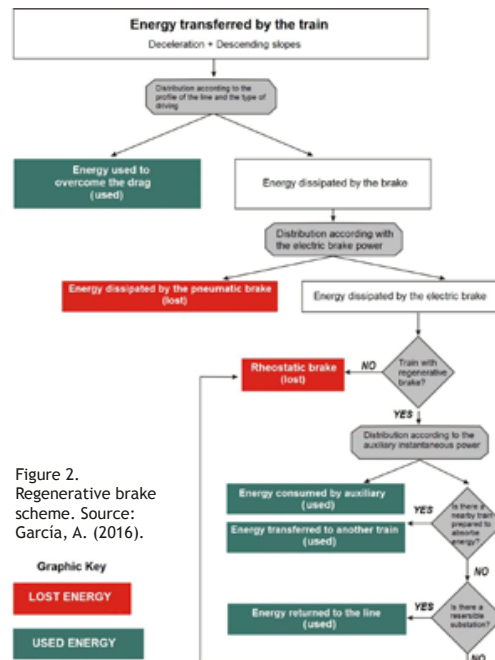

Figure 2. Regenerative brake scheme. Source: Garcia, A. (2016).

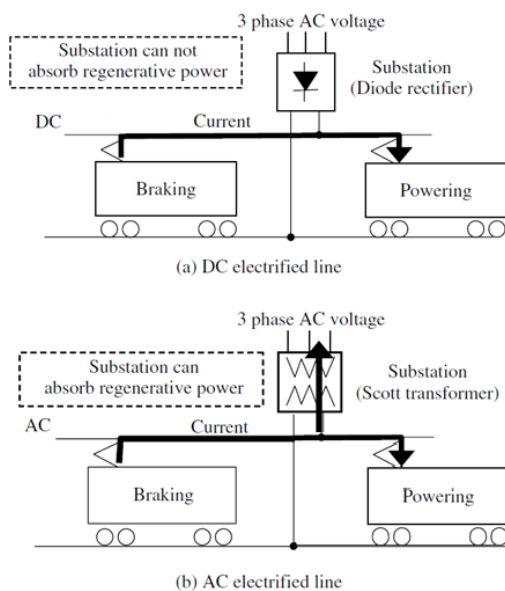

Figure 3. Regenerated energy flow in each electrified line. Source: Keiichiro Kondo (2010).

In the case of AC electrification or in DC lines with reversible substations, the energy returned to the catenary, first of all is used by other trains (if any) and if there are not trains, it is fed back into the public grid (see figure 3).

In diesel-electrical trains only a small part of braking energy can be recovered (since the storage of this energy would increase the trains weight) and this energy is used for feeding the train’s auxiliary electronic devices. The rest of the energy is dissipated in resistors as heat.

Objectives and benefits I/II

Regenerative brake aims to take advantage the train's kinetic energy to transform it into useful electricity instead of being dissipated in resistors as heat. However there is still a great potential for increasing the share of recovered energy:

- Receptivity of catenary: the use of the energy recovery, mainly, depends on the traffic density and the losses of the catenary.
- Old stock: many vehicles are not equipped with regenerative brakes.
- Drivers' acceptance and the system knowledge: the way of driving depends on the train (see technical datasheet 4.1.1.).
- Equipping DC traction substations with systems that allows to make them reversible, for example equipped with thyristor inverters.
- Equipped traction substations and/or rolling stock with energy storage systems (see datasheets 4.2.).

If the analysis focuses on the use of the energy generated and returned to the catenary and not in other technologies that can help improve the use of the energy regenerated (e.g. reversible substation, etc.) it can be asserted that this technology improves the efficiency, as it avoids energy losses by means of heating, of energy lost in the friction of the pneumatic brake or by using the rheostatic brake.

The energy generated by regenerative brake depends on the type of service; it is especially powerful on local and regional lines with frequent stops. Nevertheless, even on high speed traffic regenerative braking offers potential for energy efficiency. Below, some values obtained from different sources that provide a good picture of the potential of this technology are included.

Train Service	Citadis 302	MM 7000B	FGC UT-112	Civia 465	SE 449	AV MD	S 130 LD	S/102 AV LD
Mechanical resistances	6%	7%	9%	10%	11%	6%	11%	6%
Brake energy dissipated	34%	41%	19%	29%	37%	24%	30%	11%
Regenerated energy	7%	22%	41%	16%	2%	14%	9%	9%
Drag	1%	6%	3%	9%	19%	34%	25%	56%
Ancillary consumption	40%	14%	18%	25%	20%	8%	15%	5%
Vehicle losses	12%	10%	10%	11%	10%	13%	10%	13%

Table 1. Energy consumption percentage of the different components. Source: García, A. (2016).

As it is shown, the energy returned by the regenerative braking reaches 41% in suburban lines, and in other services the range is between 2% and 22%, as it is shown in the table above (table 1).

Objectives and benefits II/II

	At substations	Pantograph imported	Brake generated	Exploited by other trains	Returned to the grid	Lost in rehostatic	Lost without reg. brake
High Speed (25 kV)	555.8	562.4	88.9	12.8	76.1	0.0	16.6
MD-LD	228.8	151.6	11.0	2.3	0.0	8.8	6.5
Suburban train 3 kV	746.2	724.4	386.4	180.6	0.0	205.7	58.0
Freight	581.7	557.2	55.7	0.3	0.0	55.5	52.9
Suburban (<1,5 kV)	174.5	166.2	67.8	24.5	0.0	43.3	3.9
Metro	734.1	683.1	488.0	338.4	0.0	149.6	4.6
Tram	46.2	43.0	37.6	18.4	0.0	19.2	5.0
TOTAL	3,067.4	2,888.0	1,135.3	577.1	76.1	482.1	147.4

	At substations	Pantograph imported	Brake generated	Exploited by other trains	Returned to the grid	Lost in rehostatic	Lost without reg. brake
High Speed (25 kV)	98.80	100.00	15.80	2.30	13.50	0.00	2.90
MD-LD	150.90	100.00	7.30	1.50	0.00	5.80	4.30
Suburban train 3 kV	103.00	100.00	53.30	24.90	0.00	28.40	8.00
Freight	104.40	100.00	10.00	0.00	0.00	10.00	9.50
Suburban (<1,5 kV)	105.00	100.00	40.80	14.70	0.00	26.10	2.30
Metro	107.50	100.00	71.40	49.50	0.00	21.90	0.70
Tram	107.50	100.00	87.40	42.80	0.00	44.70	11.60
TOTAL	106.20	100.00	39.30	20.00	2.60	16.70	5.10

Table 2 and 3 . Energy flows in Spanish railways Source: García, A. et al. (2008).

Applications

Experimental applications

Author	Explanation	Benefits
Metro de Madrid	Through a simulation tool a case which studies the line 3 of the Madrid subway in different contexts, without regenerative brake, with regenerative brake and with regenerative brake and a bidirectional substations had been analysed.	With the use of regenerative brake, there is a reduction of approximately 30% of the energy consumed.

Real applications. Demonstrators

Author	Explanation	Benefits
Comboios Portugal	Portuguese trains have an energy saver program in which they increase the use of the regenerative brake.	There are an energy reduction due to the increase of the use of the regenerative brakes.

Bibliography

- García, A. et al. (2008). Análisis sistemático del consumo energético en líneas ferroviarias metropolitanas, de cercanías y de alta velocidad, con valoración del impacto energético y del resultado económico, incluyendo el desarrollo y contraste de modelos y simuladores parametrizables (ELECRAIL). Fundación de los ferrocarriles españoles. Madrid (Spain).
- Metro de Madrid (2012). Plan de ahorro energético. Madrid (Spain).
- Comboios de Portugal (2014). Relatório de Sustentabilidade. Portugal.
- Xin Yang, et al (2015). An energy-efficient scheduling approach to improve the utilization of regenerative energy for metro systems.
- Keiichiro Kondo (2010). Recent Energy Saving Technologies on Railway Traction Systems.
- García, A (2016). Energía y emisiones en el transporte por ferrocarril (5th edition). Fundación de los ferrocarriles españoles, Madrid (Spain).

2.3.2. Reversible substation

Introduction

Efficiency

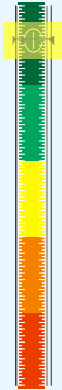

The efficiency of this measure is given essentially, by the increase of the use of the energy exported. The traction energy savings depends on the network's operational specificities and can be up to 40%

Investment

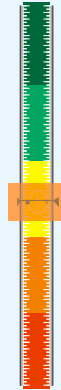

In case of DC systems the investment in a bidirectional substation is approximately 655.000 Euros, which, according to the studies analyzed, can be amortised in approximately five years

Scope of the technology

- ➔ The equipment is able to capture at least 99% of braking power, which is recovered in the electricity distribution network.
- ➔ The traction energy savings depends on the network's operational specificities and can be up to 40%.
- ➔ There is an optimization of the contracted energy, according to the reduction of harmonics and reactive power.
- ➔ The electrical system can be optimized due to the reduction of the voltage peaks. The resistors on board and DC substation circuit breakers are not needed.
- ➔ The marginal cost of this generation is null.

Field of application

	Field 0	Field 1	Field 2	Field 3	Field 4	Field 5
Field of Application	Common measures to other sectors	Measures of train and track design	Efficient use of power traction	Optimization of operations	Use of the regenerated energy	Interaction between electricity networks
Reversible substation						
		Design Measures		Redesign Measures		Operation Measures

Technology analysis I/II

One of the main objectives of a reversible substation is to increase the use of the energy generated in the regenerative brake. In simple terms, the energy generated in the regenerative brake can be partly used for on-board consumption (ancillary systems) and the remaining part can be returned to the catenary or 3rd rail (see the datasheet 1.3.1).

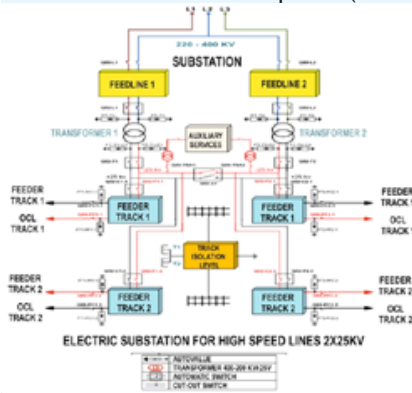

Figure 2. 2x25 scheme. Source: Adif. (2016).

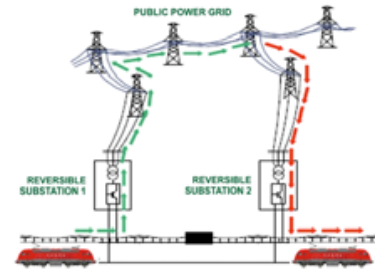

Figure 1. Energy flow in railways. Source: Adif. (2016).

However, the possibility of an effective re-use of such regenerated energy depends on two technical aspects: (i) The receptivity of the traction system and (ii) the use of Reversible Traction Substations.

Regarding reversible traction substation, the most commonly recognizable solutions are: (i) AC Systems (with the same operating frequency 50Hz or operating at different frequency; e.g. 15kV 16,67HZ traction systems), and (ii) DC Systems.

A. AC Traction System with the same operating frequency

The AC 50Hz traction systems are inherently reversible. Currently in most high speed lines, electricity is already returned to the power grid.

Figure 1 shows the electricity flows and figure 2 the components of a 2x25 kW electric substation.

B. AC Traction System; Reversible frequency converter for 15kV 16,67HZ traction systems.

In such systems the possibility of feeding the excess of regenerative braking energy to the Public Grid is directly related to the bi-directional capability of frequency converters. Four different types of frequency converters can be highlighted:

1. Rotary Frequency converters

The structure of a Rotary Frequency Converter is comprised of 3-phases 50 Hz asynchronous motor and a synchronous 16,67 Hz generator. Both devices are mechanically connected by a common shaft in order to transform frequency from 50 Hz to 16 2/3 Hz. Besides, a transformer on the secondary side of the converter is necessary to adapt the traction side to 16.5 kV (see figure 3).

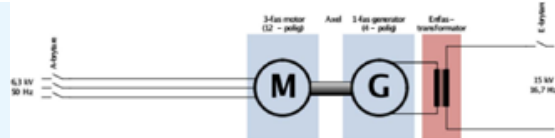

Figure 3. In-principle structure of a rotary frequency converter. Source: Merlín (2013).

2. Cycloconverters

In this type of systems the frequency transformation is carried out through a particular topological arrangement of the thyristor bridges (see figure 4).

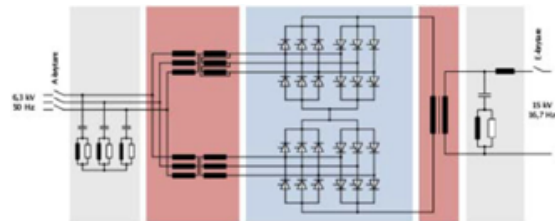

Figure 4. In-principle structure of a Cycloconverter. Source: Merlín (2013).

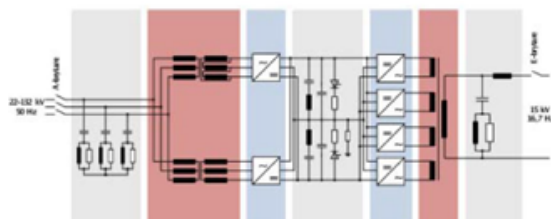

Figure 5. In-principle structure of DC-Link Converter Source: Merlín (2013).

3. DC-Link converters

These devices consist of a 50 Hz rectifier bridge producing direct current which is then inverted to produce AC of 16 Hz. Transformers are also included on both AC input and output circuitry in order to change voltage levels and number of phases.

Technology analysis II/II

4. Multilevel Converters

This device is a new solution for static converters that consists of a Cycloconverters with several IGBT modules connected in series.

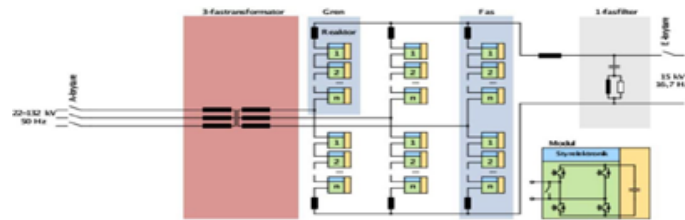

Figure 6. In-principle structures of Multi Level DC-Link converters. Source: Merlin (2013).

C. DC Traction System

Traditional DC traction substations are unidirectional because the rectifier diodes allow unidirectional flow power. In this traction system, the part of the energy regenerated in the regenerative brake which is not used to feed the on-board ancillary systems and is not used by other trains is generally dissipated by using braking resistors (rheostatic brake). The difference between traditional substation and DC reversible substation is the replacement of the classic rectifier by a new set of rectifier-inverter (see figure 7 and 8).

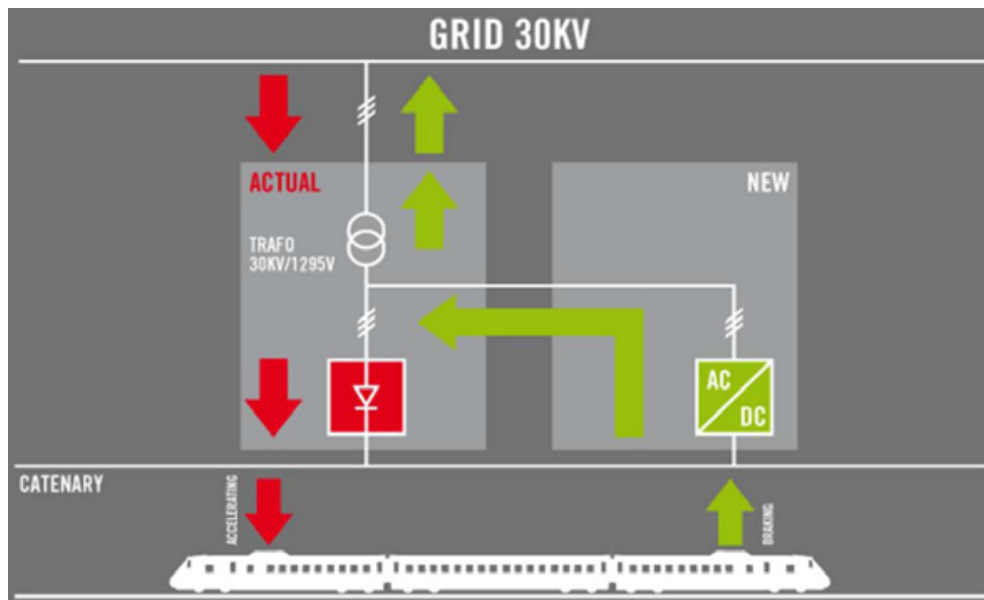

Figure 7. Reversible substation scheme. Source: Romo, A (2015).

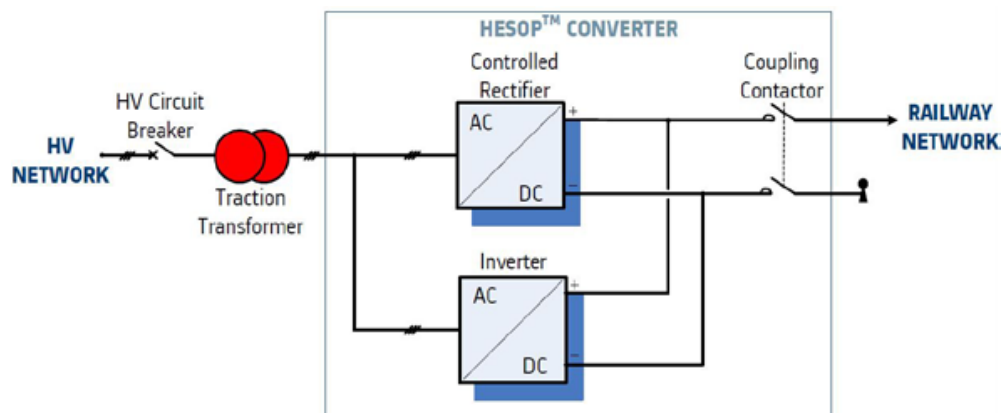

Figure 8. Architecture of the prototype power converter. Source: Cornic, D. (2010).

Objectives and benefits

The objectives of a reversible substation is to regenerate up to over 99% of the braking energy, allowing the removal of on-board braking resistors, optimizing the dynamic power balance between adjacent substations and compensate for dynamic fluctuations of primary voltage. In addition to this, the rolling stock can be less heavy due to the braking resistors and related equipment are no longer needed, which also means a gain in terms of space and cost.

The increase of exported energy to the grid leads to a better efficiency of electrical system, and then, a reduction of emissions associated to the generation. On the other hand, the integration of this energy to the public electric market will reduce the use of less efficient technologies. In terms of frequency converter efficiency, table 1 show the results according to the different types of technology.

Type of Frequency Converter	Achievable Efficiency	Reversibility	Other Characteristics
Rotary frequency converter	From 88% to 93%	Yes	<ul style="list-style-type: none"> ·High overload capability. ·Necessity of synchronization with the 50 Hz grid before entering into normal service. ·Lower possibility of control than the static converters.
Cyclo-converters	It can reach 96-97%	Yes	<ul style="list-style-type: none"> ·Almost instantaneous synchronization with the power distribution network. ·Output voltage presents big harmonic contents. ·Low overload capability.
DC-Link converters	It can reach 97-98%	Yes (Only modern DC-Link Converters)	<ul style="list-style-type: none"> ·Control of voltage angle and voltage level in order to balance the active and reactive power flows between substations for losses reduction purpose. ·Almost instantaneous synchronization with the power distribution network.
Multi Level DC-Link converters	It can reach 98.5%	Yes	<ul style="list-style-type: none"> ·Negligible harmonic content in the output voltage. ·The redundant architecture ensures high level of service availability allowing normal operation even in case of one faulted module per branch.

Table 1. Main basic facts for frequency converters. Source: Merlin (2013).

Applications

Real applications. Demonstrators

Author	Explanation	Benefits
Metro de Bilbao	In 2012 Metro de Bilbao has started to implement reversible substation in DC lines.	There is an economic saving, a reduction of approximately 7% of consumed energy, due to the increase of the energy exported and its use, which implies a reduction of CO ₂ emissions. Metro de Bilbao data shows that the economic saving is 562.104€ per year and the energy reduction is 5.363.342 kWh per year.
Author	Explanation	Benefits
Alstom	The substation HESOP which can reach an energy reduce in urban transport like metro or tram. This substation was implemented in the T1 line on the Paris tram, it is being constructed in Riad metro and the tram of Sidney and it would be enforced in other cities.	There is an energy saving, approximately 40%, and an economic saving, due to the increase of the energy exported and its use, which implies a reduction of the CO ₂ emissions.
Author	Explanation	Benefits
Adif	“La Comba” is a pioneering system in rail systems 3,000 V DC in Europe, which allows the recovery and utilization of the energy which is generated in the trains braking and not used by others, avoiding the dissipation at the rheostatic brake.	It can return to the grid more than 84,000 kWh per month. It is the equivalent to not produce the 34 tons of CO ₂ per month. It has reduced 11,464 € between November and December 2014. Due to the return of 172,685 kWh to the grid (12.75% of consumption).

Bibliography

- García, A. et al. (2008). Análisis sistemático del consumo energético en líneas ferroviarias metropolitanas, de cercanías y de alta velocidad, con valoración del impacto energético y del resultado económico, incluyendo el desarrollo y contraste de modelos y simuladores parametrizables (ELECRAIL). Fundación de los ferrocarriles españoles, Madrid (Spain).
- Metro de Madrid (2012). Plan de ahorro energético. Madrid (Spain).
- Ortega, J. M. (2011) Ingeber system for kinetic energy recovery & metro de Bilbao experience. Bilbao (Spain).
- Gonzalez, I. et al. (2015). Regenerative energy and the different traction systems. Fundación de los ferrocarriles españoles. Madrid (Spain).
- Alstom (2015). Hesop All-in-One Energy and Cost Saver.
- Cornic, D. (2010). Efficient recovery of braking energy through a reversible DC substation. Electrical Systems for Aircraft, Railway and Ship Propulsion (ESARS).
- García, A. (2016). Energía y emisiones en el transporte por ferrocarril (5th edition). Fundación de los ferrocarriles españoles, Madrid (Spain).
- Via libre (2014). La subestación de La Comba ya transfiere la energía del frenado de los trenes a la red 14/11/2014. Madrid (Spain).
- Adif (2015). Adif ahorra casi 12.000 euros en energía eléctrica en sólo dos meses gracias a la subestación de La Comba. 25 February. 2015, (Spain).
- Romo, A. (2015). Reversible substation in heavy rail. Energy recovery workshop. INGETEAM Power Technology,S.A. - Traction. Tuesday 29th - September 2015, Madrid (Spain).

2.3.3. Neutral zones

Introduction

Efficiency

Energize neutral zones or its emplacement can reduce travel times that enable an efficient eco-driving, which leads to a reduction of CO₂ emissions. In addition, energized neutral zones can reduce also power peaks.

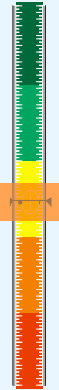

Investment

Generally locate substations in lower areas, to avoid high decelerations, has not got an additional cost. On the other hand, energizing neutral zones will need to assume an additional cost due to the necessary switchgear.

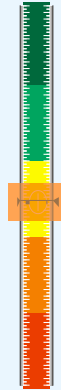

Scope of the measure

- ➔ There is a decrease of approximately 32% and 21% in the peak magnitude of the inrush current, depending if the price of the public transferring device is taking into account.
- ➔ There is a decrease of approximately 34% and 4% in the losses of the transformers, depending if the price of the public transferring device is taking into account.
- ➔ There is a reduction on the maintenance costs.
- ➔ There is a decrease too on the train failures and an increase on the train components lifetimes.

Field of application

	Field 0	Field 1	Field 2	Field 3	Field 4	Field 5
Field of Application	Common measures to other sectors	Measures of train and track design	Efficient use of power traction	Optimization of operations	Use of the regenerated energy	Interaction between electricity networks
Neutral zones						
		Design Measures		Redesign Measures		Operation Measures

Technology analysis

When AC railways are fed with transformers connected to a three phase grid, neutral zones are necessary. Those zones do not have power supply, which means that trains are no longer fed in there.

Figure 1 shows two different phases of the grid feeding the train and the neutral zone that separate both.

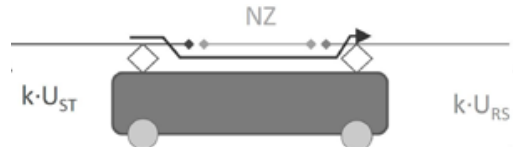

Figure 1. Bypass to be avoided that determines NZ length. Source: Pilo, E. (2014).

Figure 2 shows a scheme of AC grid.

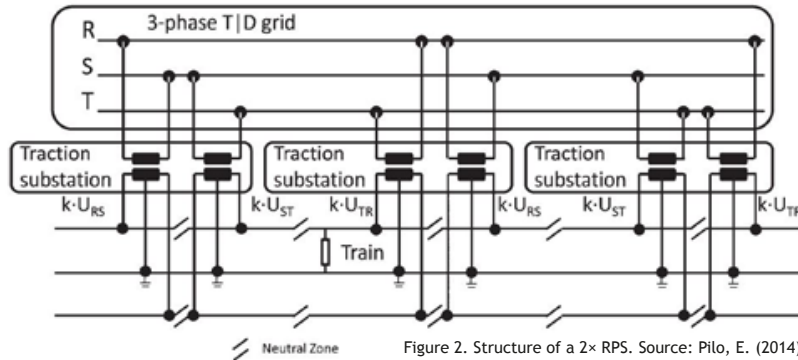

Figure 2. Structure of a 2x RPS. Source: Pilo, E. (2014).

Measures to avoid neutral zones:

1) Emplacement of neutral zones: the coasting of the train could be a problem due to the reduction of energy traction which means a big reduction on the speed, and this happens in slopes steeper than 5%. To solve the problem a study of the best place to locate the neutral zones is necessary, trying to install these neutral zones in places where the slopes are less than 5%. This study could be completed with some simulations in order to know the most efficient area.

2) Energize neutral zones: there are other two technologies, apart from the emplacement of the neutral zones, that can solve the non electrification zones problem.

- The first one is the elimination of neutral zones by feeding the train through converters stations. This is a good solution in the infrastructure design process or when a single-phase T&D grid is already available. a scheme where the converters should be installed in the grid is shown in figure.

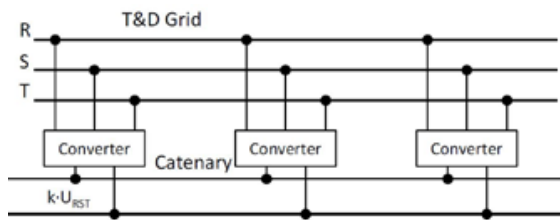

Figure 3. Power-supply system using converter . Source: Pilo, E. (2014).

- The second one is the use of an automated changeover switch system. This can feed the neutral zone when the train is on it. Figure 4 shows the changeover switch.

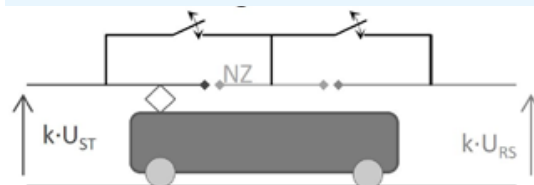

Figure 4. Bypass to be avoided that determines NZ length. Source: Pilo, E. (2014).

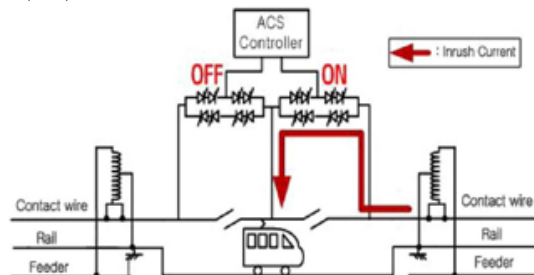

Figure 5. Electric railway system with ACS system and SFCL.. Source: Hee-Sang Shin (2011).

Objectives and benefits

The objectives of both solutions, the one that is based on locating neutral zones in the best emplacement, and the one that is based on the energizing neutral zones, allow a gain in time that can be used in eco-driving strategies which are already explained at the technical datasheet 4.1.1. Moreover, the solutions based on the elimination of neutral zones, has other benefits as the reduction of the energy power peak at the substation and the losses in the transformers.

Table 1 shows the energy losses and energy peaks reduction at the substations in a simulated case between Madrid and Barcelona which complete the actual infrastructure with additional power-electronic devices, to allow the control of the power flow in neutral zones. This study was carried out by E. Pilo et al. (2014) in two different scenarios.

Those scenarios are different due to the price of the public transferring device (PTD) is very difficult to estimate. Scenario A where no cost has been considered for PTD and scenario B, where the cost of PTD has been assumed to be 410. C/kVA.

Figure 6 shows the difference between the original current profile and the new one with at he PTD.

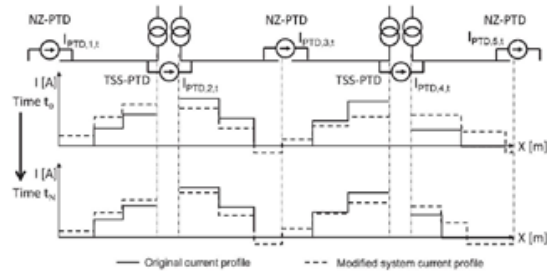

Figure 6. Per-phase current distribution along the catenary. Source: E.Pilo (2014).

Per 1 year period	Reference system	Enhanced system	
		Scenario A	Scenario B
Peak capacity required at substations (MW)	350	238	275
Variation (comp. to reference)	-	-32%	-21%
Cost of the power capacity (K€)	8,375	5,696	6,585
Electrical losses (MWh) in catenary	5,293	5,053	5,572
Variation (comp. to reference)	-	-5%	5%
Cost of the electrical losses in catenary (K€)	371	354	390
Electrical losses (MWh) in transformers	2,737	1,813	2,620
Variation (comp. to reference)	-	-34%	-4%
Electric losses costs in transformers (K€)	192	127	183
Manageable electrical cost reduction (M€)	-	-2,760	-1,778
Variation (comp. to reference)	-	-31%	-20%
Cost of the PTDs (K€) per year	-	0	2,293

Table 1. Economic analysis. Source: E. Pilo (2014).

The results obtained underlined that in scenario A, the PTD would be able to minimize 32% of the power capacity and 31% of the losses. In scenario B, there is a reduction of 20% in the manageable costs, due to savings in power capacity (21%). Taking into account that the system is able to route the electrical power from different substations to the sectors where it is required, the currents cross longer distances, which implies more losses in the catenary (+5%). The losses in the transformer are, however, reduced (4%).

Applications

Experimental applications

Author	Explanation	Benefits
Hee-Sang Shin	In order to mitigate the problem in neutral zones there is a paper which proposes a method based on a limitation of the current, the SFCL system. The picture 5, analysing the measure, shows a scheme of the system.	There is a decrease of approximately 25% in the peak magnitude of the inrush current. There is a decrease too on the train failures and an increase on the train component lifetimes. Thus, it's expected that the use of the SFCL can increase the reliability of electric railways.

Bibliography

- Pilo, E. et al. (2014). Smart Electrical Infrastructure for AC-Fed Railways With Neutral Zones. IEEE Transaction on intelligent transportation systems. Madrid (Spain).
- Hee-Sang Shin et al. (2011). Protection Scheme Using SFCL for Electric Railways With Automatic Power Changeover Switch System. VOL. 22, NO. 3, June 2012. Seoul (Korea).
- Pilo, E. et al. (2014) Neutral zones in AC railways: an overview. Madrid (Spain).
- Hee-Sang Shin et al. (2011). Application on of SFCL in Automatic Power Changeover Switch System of Electric Railways. IEEE Transactions on applied superconductivity. VOL. 22, NO. 3, June 2012. Seoul (Korea).
- Martínez, J. C. (2011). "IFZONE" Project: improving circulation in neutral zones. 9th World Congress on Railway Research, WCRR. 22 to 26 Mai 2011. Lille (France).

Source: Fotolia



3. Measures related to ancillary systems

3.1. Ancillary systems on board

3.1.1. On board HVAC

3.1.2. Train lighting system

3.1.1. On board HVAC

Introduction

Efficiency



By implementing different elements such as more efficient devices and smart systems to regulate HVAC (Heating, Ventilating and Air Conditioning) it is possible to manage the on board temperature more efficiently, hence reducing the energy consumption of rolling stock.

Investment

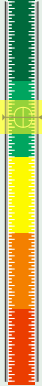

This set of measures requires the installation of sensors and other control elements to measure CO₂ and regulate the system. The cost of such devices is relatively low. Implementing new refrigerants may require a refitment of the system and thus higher implementation costs.

Scope of the technology

- ➔ The system is expected to reduce HVAC energy consumption by 13%.
- ➔ According to some simulations, the implementation of all the measures proposed shown a saving potential of 40%. A more efficient HVAC reduces the amount of energy consumed by rolling stock.
- ➔ New developments can control the air quality and estimate the number of passengers in real time. With this information, this new systems are capable of adjusting fresh air intake from the outside and regulates temperature more accurately according to passenger needs. Some estimates and models calculate energy savings between 15% and 30%.

Field of application

	Field 0	Field 1	Field 2	Field 3	Field 4	Field 5
Field of Application	Common measures to other sectors	Measures of train and track design	Efficient use of power traction	Optimization of operations	Use of the regenerated energy	Interaction between electricity networks
HVAC on board						
		Design Measures		Redesign Measures		Operation Measures

Technology analysis

Railway vehicles are equipped with several auxiliary systems that provide comfort to passengers and help deliver a better transport service. These ancillary systems (also known as ‘hotel loads’) include lightning, automatic doors, loudspeakers, etc. Although traction usually consumes the biggest share of the total energy supplied to a train, the share of energy devoted to power auxiliary systems is significant, and may range from 10-15% to almost 50% of the total energy (UIC, 2015).

Heating, Ventilation and Air Conditioning systems (HVAC) are by far the biggest energy consumer of all ancillary systems, as they usually represent up to 80% of all hotel loads (Martínez et al., 2015). Therefore, the efficiency of HVAC systems have a great impact on the overall energy consumption of a train.

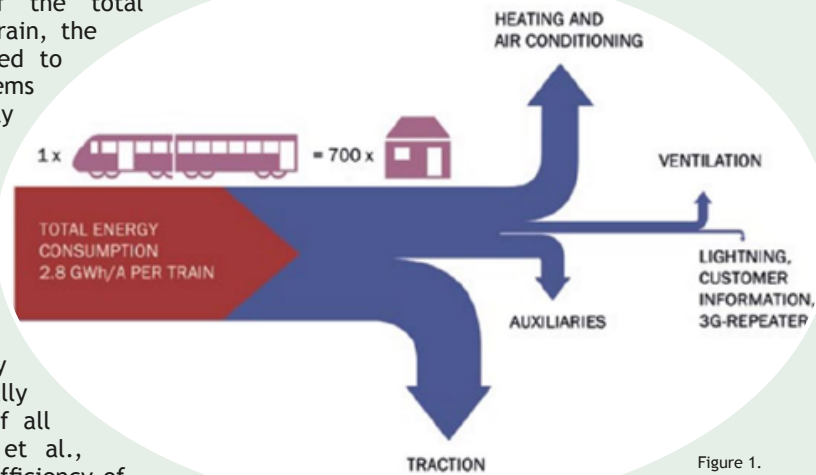

Figure 1. Example of energy consumption distribution on a train. Source: UIC Handbook 2015.

There are several different HVAC configurations within the railway sector as there is little standardization of such systems. However, most of them are based on the same basic principle of heat transfer and consist of a condenser and an evaporator.

The compressor (4) pumps the refrigerant into the condenser (1), where it heats up and energy is released to the air. The refrigerant then passes through the expansion valve (2) into the evaporator (3) where it evaporates into a cold gas, thus extracting heat from the ambient air (Schaffler). Multiple different configurations and variants are built upon this basic scheme.

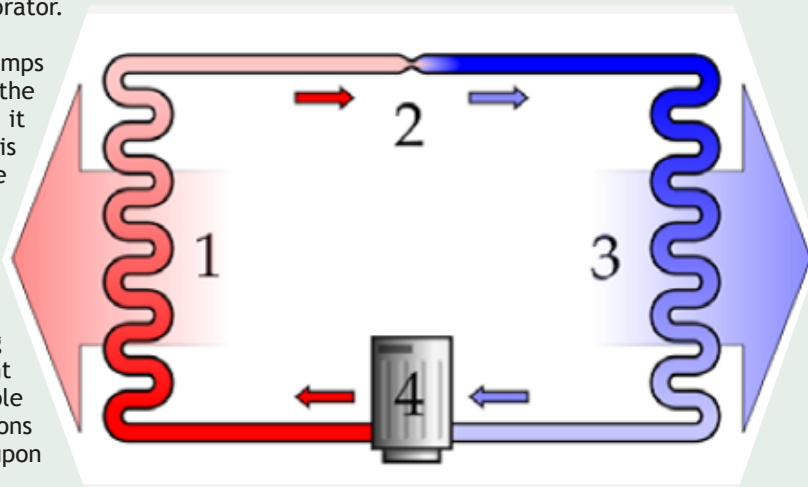

Figure 2. Basic HVAC configuration. 1) Condenser. 2) Expansion valve. 3) Evaporator. 4) Compressor. Source: Schaffler.

Objetives and benefits

HVAC systems are heavy energy consumers, and have the biggest impact on the overall train energy consumption of all non-traction loads. There is an ongoing research being carried out by manufactures to increase the efficiency of their products. The following measures are proposed to reduce the energy consumed by HVAC systems:

- New refrigerants.

Most HVAC systems are filled with a refrigerant liquid that passes through the heat cycle and helps transferring heat from hot to cold sections. Traditional refrigerants such as R-22 (Hydrochlorofluorocarbon) were used extensively in the past, but due to their adverse effect on the ozone they are being actively substituted with less damaging gases such as R-410A (Hydrofluorocarbon). These gases allow higher air conditioning performance, hence reducing power consumption. Newer, natural refrigerants such as R744 (liquid carbon dioxide) or HFO-1234yf (2,3,3,3-Tetrafluoropropene) are currently being tested and preliminary prototypes shown even more reduction of GHG emissions and energy consumption.

- Smart HVAC management.

CO₂ monitoring is becoming standard practice and may help reducing energy costs by cutting off peak heating and cooling loads. By installing CO₂ sensors, the on board HVAC system can control the air quality and estimate the number of passengers in real time. With this information, the system is capable of adjusting fresh air intake from the outside and regulates temperature more accurately according to passenger needs, hence reducing energy consumption. Some estimations and models calculate energy savings between 15% and 30%.



Figure 3. Hvac unit.
Source: Merak.

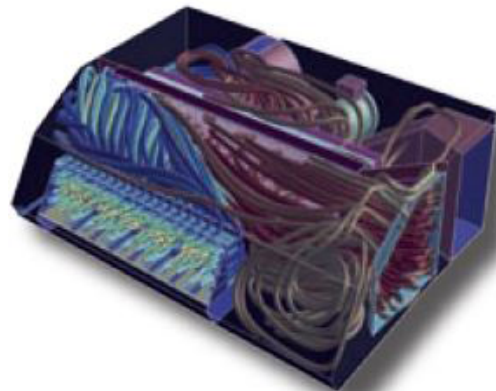

Figure 3. Computational Fluid Dynamic (CFD) studies of HVAC unit. Source: Merak.

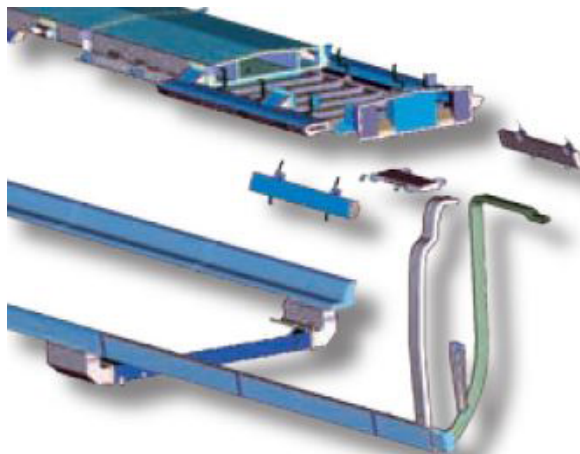

Figure 3. 3D Ducting Works. Source: Merak.

Applications

Theoretical applications

Author	Explanation	Benefits
University of Basel Swiss Federal Office of Energy Swiss Federal Office of Transport	About 20% to 40% of electricity consumed by Swiss trains is used for HVAC. Aiming at the improvement of efficiency, heat losses were monitored and modelled and several improvements were proposed, such as better insulation and the installation of heat recovery systems. Reduction of outdoor air flow rate by means of CO ₂ control was also proposed.	According to simulations, the implementation of all the measures proposed showed a saving potential of 40%. For the whole fleet of EWII vehicles operated by Swiss Rhaetian Railway, this yields an annual saving potential of 840 MWh.

Real applications. Demonstrator

Author	Explanation	Benefits
Berlin City Transport Operator (BVG) Liebherr-Transportation Systems	Liebherr will equip one of Berlin trams with an experimental occupancy-dependent fresh air control based on CO ₂ sensors that estimate the number of passengers and regulate the intake of fresh air.	This new system is expected to reduce HVAC energy consumption by 13%.

Bibliography

- UIC (2015). Railway Handbook 2015. Energy Consumption and CO₂ emissions. Available at: <http://uic.org/energy-and-co2-emissions> (accessed 27/07/2016).
- Martínez, P. et al. (2015). Measuring and modelling energy consumption in metro trains by means of neural networks. 13th Railway Engineering Conference. Edinburgh, Scotland, UK, June 30 - July 1, 2015.
- Schaffler. Air conditioner power systems for rail. Available at: <http://www.schaffler.com> (accessed 27/07/2016).
- Vetterli, N et al. (2015). Energy efficiency of railway vehicles. CISBAT, Lausanne, Switzerland, September 9-11, 2015.

3.1.2. Train lighting system

Introduction

Efficiency



By implementing new technologies that substitute conventional lighting systems such as LED lamps and smart circuit designs and devices, it is possible to reduce the energy consumption by 40% at least and increase the life cycle of the entire system, reducing the associated CO₂ emissions at the same time.

Investment

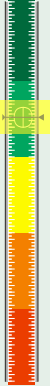

Although more expensive than previous forms of lighting such as fluorescent and HID lamps, LED lighting systems will be used increasingly in the future due to their lower maintenance costs, energy efficiency and longer life cycle.

Scope of the technology

- ➔ A LED lighting system with a suitable circuit design and devices reduces the energy consumption by 40 to 60% compared with fluorescent lighting.
- ➔ The new developed LED features circuit give it a life span of 100,000 hours (16 years) instead of 40,000 hours (typical for conventional LED).
- ➔ A more efficient lighting reduces the total amount of energy used and thus the emissions of CO₂.

Field of application

	Field 0	Field 1	Field 2	Field 3	Field 4	Field 5
Field of Application	Common measures to other sectors	Measures of train and track design	Efficient use of power traction	Optimization of operations	Use of the regenerated energy	Interaction between electricity networks
Train lighting system						
		Design Measures		Redesign Measures		Operation Measures

Technology analysis

Although lighting is not the biggest energy consumer on board trains, averaging only 4% of the energy demand of comfort functions, it is possible to improve features such as functionality, energy efficiency, design, maintenance and environmental impact by means of adopting new technologies in lighting systems.

With energy efficiency becoming increasingly important in recent years, demand is growing for the adoption of LED lighting as a replacement for fluorescent interior lighting in passenger trains.

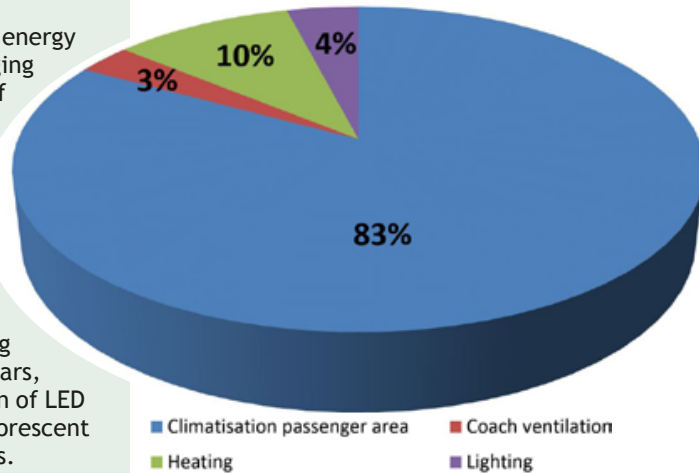
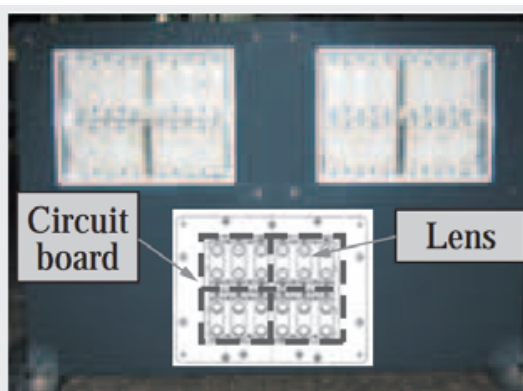

Figure 1. Energy demand of comfort functions in trains. Source: Knau (1993).

Taking as a reference the Japanese Industrial Standard for lighting levels in rolling stock, for passenger train interiors, the standard stipulates 200 lx or more at a height of 850 mm above the floor. The wavelength of LED light (roughly 450 to 500 nm) is shorter than that of fluorescent light (roughly 550 nm), and this gives it a characteristic bluish tint. Because the light is whiter than fluorescent lighting with emission intensity about 1.3 times stronger, text and similar on illuminated objects have a crispier appearance than when fluorescent lighting is used.

On the other hand, because it is produced in a discharge tube, fluorescent lighting has a spread of 360°. In contrast, the angle of light spread for typical LED lighting is approximately 120°, only about one-third than that of fluorescent lighting. This means that, compared to fluorescent lighting, there is little illumination intensity to be gained by using a reflector with an LED light.



Front view of LED headlight

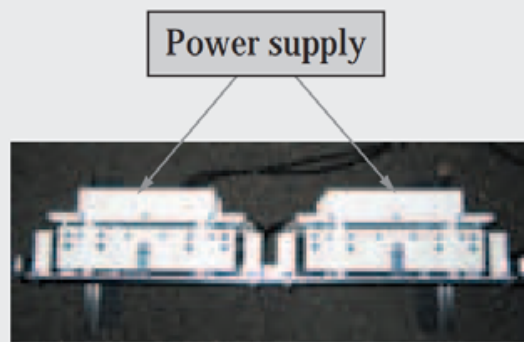

Top view of LED headlight

Figure 2. LED Headlight Design where the highlight is split into four blocks: upper blocks for high beam and lower blocks for low beam. Source: Hitachi. (2012).

Finally, it is worth noting that, currently, halogen lamps or high-intensity discharge (HID) lamps are used for train headlights to improve forward visibility. However, these need to be replaced annually, and in the worst cases, once every three months. Because of their importance for ensuring safety, headlights should be replaced using LED equipment in order to provide excellent visibility and longer life cycle.

Objetives and benefits

The purpose of installing LED technology on board trains is to get some advantages with respect to conventional lighting systems that are listed below:

- Lower power consumption

LED lighting is more energy efficient than fluorescent lighting, cutting energy costs and carbon dioxide (CO₂) emissions almost by half.

- Elimination of flickering

LED lighting is ideal for use in trains because it is powered by direct-current (DC) electric power and does not produce the flickering that occurs with fluorescent lighting. This should reduce eye strain.

- No emission of ultraviolet rays

As the spectrum of light produced by LEDs depends on the semiconductor and phosphor material, unlike most other light sources such as fluorescent and incandescent lighting, it does not include any of the ultraviolet or infrared rays that do not provide any illumination. Similarly, it is also less prone to attracting insects because it produces very little ultraviolet light in the part of the spectrum visible to insects. This means that LED lamps are less prone to insect related dirt.

- Reduction in life cycle costs

As the life cycle of a LED element is approximately 40,000 hours, it significantly reduces the work associated with the frequent replacement, lighting on/off control, stock control, and waste disposal tasks that are an issue for halogen, fluorescent, and other forms of conventional lighting.

The lifetime of a LED lighting system is defined as the point at which the brightness falls to 70% of its initial level. As the principle of operation of LED lighting systems means that they are not subject to the phenomenon of burn out that occurs on halogen and fluorescent light bulbs, they do not need to be replaced before reaching their design lifespan. Similarly, it is not necessary to keep spares on hand in case of light bulbs burning out.

Finally, as the intensity of LED light is roughly proportional to the electric current, it is possible to establish circuit designs and devices that keep the current low without loss of light intensity, getting as a result an approximate 40% to 60% reduction in power consumption compared to fluorescent lighting.

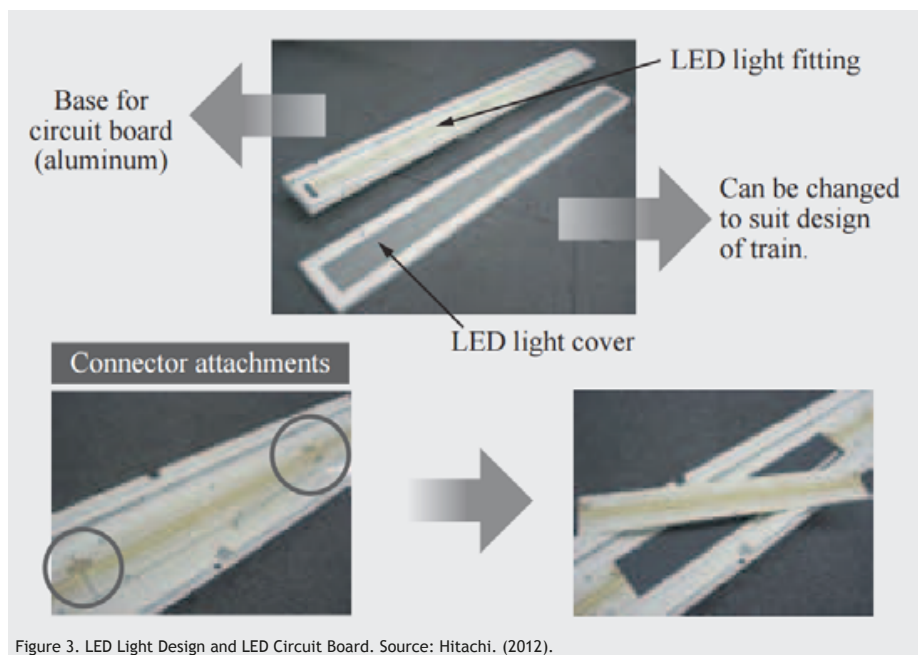

Figure 3. LED Light Design and LED Circuit Board. Source: Hitachi. (2012).

Applications

Theoretical applications

Author	Explanation	Benefits
Hitachi (Japan)	Hitachi intends to continue developing and designing rolling stock systems for easier maintenance and superior energy efficiency in order to provide operators with efficiency improvements while also improving passenger comfort by taking into account the entire rolling stock system. In this way, the company has developed a LED lighting system improved with circuit designs and devices that keep the current low without loss of light intensity.	The new developed LED features circuit and board configurations that are resistant to the effects of heat and designed for long life, reaching a life span of 100,000 hours (16 years) instead of 40,000 hours (typical for conventional LED).

Real applications. Demonstrator

Author	Explanation	Benefits
Osaka Municipal Subway Midosuji Line (Tokyo)	About 30,000 railway vehicles are scheduled to go into operation in the fall of 2016 with Kawasaki's newly developed LED lighting and air purification system.	The new LED lighting system achieves outstanding energy efficiency and passenger comfort. It will be the first to adopt a cherry blossom-light on a railway vehicle. The pale-pink light has the effect of reducing stress caused by being exposed to artificial light, as well as providing a sense of healing and being easy on the eyes.

Bibliography

- Energy efficiency strategies for rolling stock and train operation. Railenergy.
- Ishii, I. et al. (2012). LED Lighting System for Rolling Stock. Hitachi Review.
- Kawasaki (2015). Kawasaki Develops New LED Lighting and Air Purification Systems for Rolling Stock. Kawasaki news and events. December 2015.

3.2. Depots and stations

- 3.2.1. HVAC in railway stations
- 3.2.2. Lighting system
- 3.2.3. Escalator

3.2.1. HVAC in railway stations

Introduction

Efficiency

HVAC (Heating, Ventilating and AirConditioning) systems are heavy energy consumers, particularly in large train stations and depots. By implementing different elements such as more efficient devices and smart systems to regulate HVAC, it is possible to manage the temperature of stations more efficiently, hence reducing the energy expenditure and associated CO₂ emissions.

Investment

This set of measures requires the installation of sensors and other control elements to regulate the HVAC system. The cost of such devices is relatively low compared to the cost of the whole HVAC system. If more efficient equipment (cooling towers, pumps) are also installed, the cost increases significantly.

Scope of the measure

- ➔ A more efficient HVAC reduces the amount of energy consumed by train stations and other large facilities.
- ➔ The implementation of automatized management for the chiller plant may allow savings between 17% and 30% of energy compared with manual operation or current standard Building Automation.
- ➔ The estimated reduction compared with fixed flow rate system at stations, is at least 20% of the pumped energy.
- ➔ The return on investment occurs in about 4-5 years.

Field of application

	Field 0	Field 1	Field 2	Field 3	Field 4	Field 5
Field of Application	Common measures to other sectors	Measures of train and track design	Efficient use of power traction	Optimization of operations	Use of the regenerated energy	Interaction between electricity networks
HVAC						
		Design Measures		Redesign Measures		Operation Measures

Technology analysis

Railway stations have some characteristics that have a huge impact on energy consumption: they are massive structures with high window-to-wall ratios and large floor spaces. Railway stations also have high occupancy rates and are often in operation almost 24 hours a day. According to an energy survey conducted in large stations in 2011 (Asian Development Bank, 2015), energy consumption is about 214 kWh/m² per year; compared with other large public buildings whose energy consumption is about 114 kWh/m² per year, railway stations have high energy-saving potential. Air-conditioning systems (HVAC) are one of the major energy-consuming equipments in railway stations because they require about 68% of the total energy consumption.

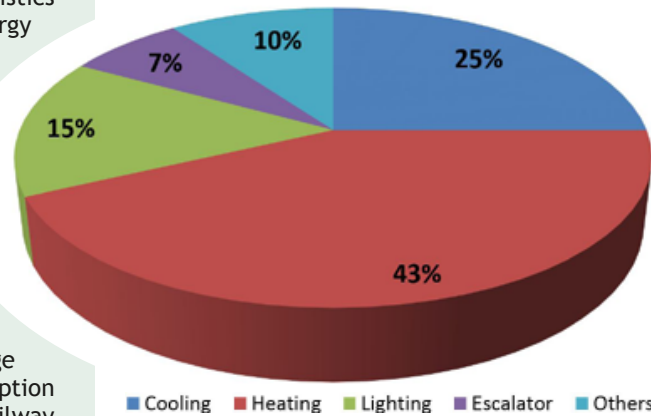

Figure 1: Railway Station Building Energy Statistical Classification. Source: Asian Development Bank (2015).

HVAC are complex systems with several elements that require different amounts of energy. Hot and cold source requires the largest share of energy within a HVAC system, accounting for 45% of the total energy consumption.

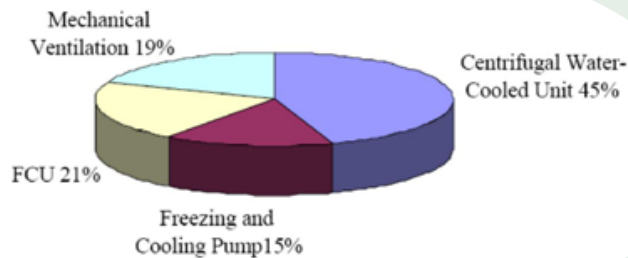

Figure 2: The Energy Consumption Ratio of the Various Parts of Air-Conditioning System. Source: Yi Jiang (2005).

Taking into account this data, air-conditioning systems need improved everyday operation and maintenance in order to get “smart railway stations” with more efficient and sustainable behaviour.

A successful energy saving plan regarding HVAC systems in railway stations should establish measures based on following criteria:

- Indoor dry bulb temperature index in the station: temperatures need to be set for winter and summer months, and different station zones may use different temperatures.
- Indoor relative humidity index: seasonal changes in humidity need to be determined.
- Indoor air quality index in station: carbon dioxide concentration is mostly used as a measure.

Equipment Name	Power
Centrifugal Water-cooled Unit	Cooling capacity 3,059 kw, electric power 530 kW
Freezing Water Pump	Rated Power 90 kW
Cooling Water Pump	Rated Power 90 kW
Fan Coil Unit	Total Power 494.825 kW
Tank Lifting Air-conditioner Unit	Rated Power 3 kW

Table 1: Main air-conditioning equipment in Guangzhou railway station. Source: Yi Jiang (2005).

Objetives and benefits

HVAC systems consume a big amount of energy, particularly in large stations and other facilities related to railway networks, such as depots. In order to reduce the energy consumed by such systems, as well as to decrease GHG emissions, some modifications may be applied to Air Conditioning systems that increase their overall efficiency and cut their energy expenditure. Three different, complementary measures are proposed:

- Smart HVAC management using CO₂ sensors.

The installation of Carbon Dioxide (CO₂) sensors allow regulating outdoor air supply to the premises, adjusting fresh air supply rates to public areas while ensuring CO₂ levels below a given safe value. In this way, energy consumption may be reduced while maintaining air quality. CO₂ monitoring is becoming standard practice and may help reducing energy costs by cutting off peak heating and cooling loads. In order to ensure the effectiveness of this measure, a thorough assessment of the location of the sensors within the premises is essential, as well as proper calibration of each device.

- More efficient equipment.

Heating, Ventilation and Air Conditioning (HVAC) systems are complex installations with multiple elements, but a few of them consume the largest share of the total energy consumed by such systems. Therefore, installing more efficient devices may significantly reduce the energy consumed.

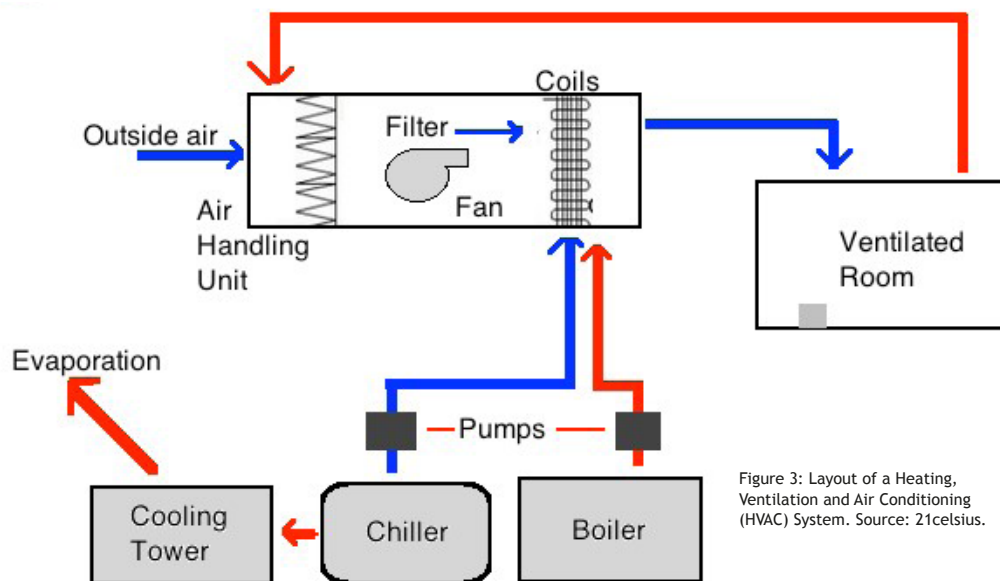

Figure 3: Layout of a Heating, Ventilation and Air Conditioning (HVAC) System. Source: 21celsius.

One of the elements that require most energy is the pumps, which are used to circulate hot, chilled and condensed water. Newer pumps are far more efficient and may save about 20% of energy (Asian Development Bank, 2015) compared to traditional pumps. Another energy-consuming element is the cooling tower used for heat rejection, which usually equips its own fans and pumps. Newer, hybrid cooling towers are more efficient than traditional ones.

- Chiller plant management system.

The implementation of automatized management for the chiller plant (which is one of the most energy-consuming elements of a HVAC system) may allow savings between 17% and 30% of energy (Asian Development Bank, 2015) compared with manual operation or current standard Building Automation.

Applications

Theoretical applications

Author	Explanation	Benefits
Guangzhou Railway Station (China)	Guangzhou Railway Station has 4 floors and 36 m height on the ground and the total building area is 22,360 m ² . The air-conditioning area is 17,020 m ² and in the related equipment, the pumps are the most energy consumptive. For this reason, the idea is switching to the combined operation of a variable frequency pump and a general water pump.	This method is secure, stable and easy for management, and the running of water pump can be changed in accordance with the changes of the construction load so as to improve the operation of air-conditioning system to save energy.

Real applications. Demonstrator

Author	Explanation	Benefits
Singapore's Rapid Transit System	Carbon Dioxide (CO ₂) Sensors are provided to regulate outdoor air supply to the stations. Installation of CO ₂ sensors automatically adjust fresh air supply rates to the station public areas while ensuring CO ₂ level is below 1000 ppm. Variable Speed Drives are also provided for Chilled Water Pumps and Cooling Towers.	This measure reduces energy consumption of the air-conditioning system without compromising air quality. The estimated reduction in energy is up to 0.36% of a typical station's power consumption. The use of variable speed drives helps to reduce the energy consumption of chilled water pumps and cooling towers during part load operation, with estimated reduction of up to 0.4% in station power consumption.

Author	Explanation	Benefits
China Railway Corporation	There are some energy-saving measures that have been implemented in railway stations: Appropriate selection of chiller type. Depends on: fuel type (electricity or gas), water cooled or air-cooled and engine type. Appropriate selection of air-conditioning water system. It suggests system designed to be as simple as possible based on variable flow of primary pump or secondary pump. Highly efficient chiller and pump based on load demand. Chiller plant management system. It is possible to adopt many control strategies based on refrigerating principals and air-conditioning product differences.	The economic impact depends on projects but in most cases a higher capital cost of producing operational energy reduction. Compared with fixed flow rate system, variable saves at least 20% of pump energy. Return on investment in about 4-5 years and will save about 20% compared with traditional pumps. Savings of 17-30% compared with manual operation or current standard Building Automation.

Bibliography

- Kai Fu et al. (2009). Current Situation of Energy Consumption in Guangzhou Railway Station and Analysis on the Potential of Energy Conservation. School of Mechanical Engineering. Southwest Jiaotong University. China.
- Yi Jiang. (2005). Current building energy consumption in China and effective energy efficiency measures. HVAC, 2005, 35(5): 30-31.
- Improving energy efficiency and reducing emissions through intelligent railway station buildings. Asian development bank, 2015.
- Thong, M. et al. (2012). Energy Efficiency in Singapore's Rapid Transit System. Journeys May 2012.

3.2.2. Lighting system

Introduction

Efficiency

Lighting systems are the second energy consumers in railway stations after HVAC systems. By implementing new technologies that substitute conventional lighting systems such as LED lamps and smart devices to control lighting, it is possible to reduce the energy consumption by 28%, hence reducing the associated CO₂ emissions.

Investment

The set of measures proposed requires making a change in the conventional lighting systems. Furthermore, it is necessary to install new types of lamps and bulbs; besides, the installation of sensors and other control elements to regulate the lighting is also required. The cost of such devices is relatively low compared with the benefit obtained.

Scope of the measure

- ➔ A more efficient lighting reduces the total amount of energy used (approximately a 28%).
- ➔ With a intelligent lighting system 17,600 kg of CO₂ emissions can be reduced annually.
- ➔ The investment of intelligent lighting controls can be returned in less than 1 year, although complicated control programs may take 3 years.

Field of application

	Field 0	Field 1	Field 2	Field 3	Field 4	Field 5
Field of Application	Common measures to other sectors	Measures of train and track design	Efficient use of power traction	Optimization of operations	Use of the regenerated energy	Interaction between electricity networks
Lighting system						
		Design Measures		Redesign Measures		Operation Measures

Technology analysis

Railway stations are categorized as large public buildings that consume a large amount of energy due to their great size and high occupant density. As it is shown in figure 1, after air-conditioning (25%) and heating (43%) systems, lighting is the second biggest energy consumer, averaging 15% of all energy consumed in large stations.

The lighting load per unit area in railway stations is about $4.1\text{W}/\text{m}^2$, using conventional lighting systems as fluorescent tubes also called energy-saving lamps.

Taking into account the large floor spaces in a railway station that are working almost 24 hours per day during 365 days per year, it is necessary to improve the management and utilization of the lighting system in order to achieve the best lighting effect and reduce power consumption.

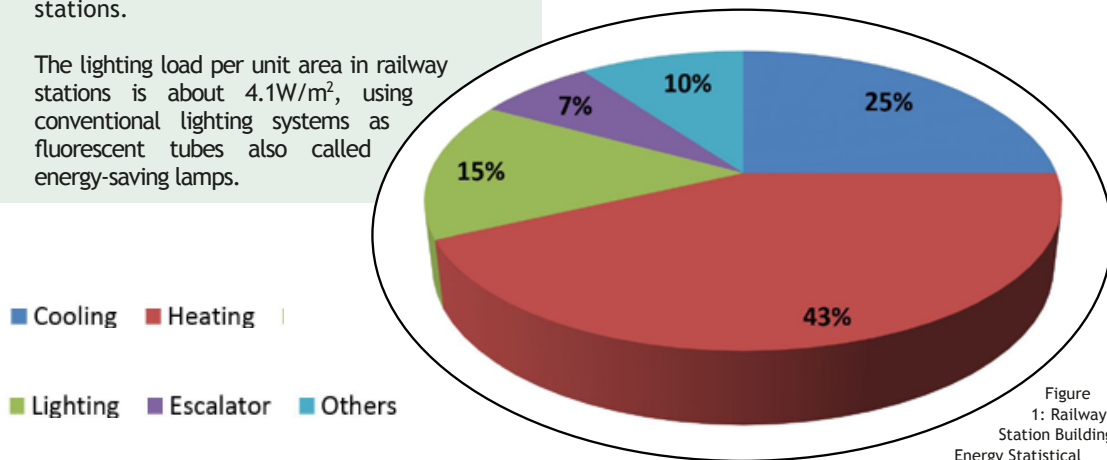

Figure 1: Railway Station Building Energy Statistical Classification. Source: Asian Development Bank (2015).

Designing lighting systems for high-speed railway stations is a complicated process due to the following reasons:

- Coexistence of high and low spaces and their interfaces.
- Interaction among different functional areas.
- Uncertainties of operation time.
- Uncertainties of lighting rate.

This is compounded by the fact that in many cases, modern lighting design has progressed faster than technology. Since many metro and light rail stations were built in the 20th century, lighting in many stations is conventional. That means that lighting with fluorescent lighting tubes and (incandescent) light bulbs is the norm. They are cheap to purchase but are also the most inefficient bulbs compared to all other types of lighting. In fact, most incandescent light bulbs convert less than 5% of the energy they use into visible light (with the remaining energy being converted into heat).

For this reason and because lighting systems have a high energy-saving potential, it is necessary to use intelligent lighting control systems, in order to optimize the quality of electricity and save lighting electricity to achieve a more efficient effect.

Objectives and benefits

In order to optimize the quality of electricity and save lighting electricity to achieve a more efficient effect, the following measures are proposed:

- Illumination daylighting control.

This enables illumination lighting control over lights on the sidewalk areas of the waiting area. These lights account for 40% of the total lighting for the entire waiting area. When illumination reaches 200 lux, lighting control would switch them off. This measure saves 4.82% of the total energy according to simulation results. It is noted that if a dimming system is used, the saving rate could be higher. Figure 2 shows two different categories of automatic daylight harvesting lighting controls.

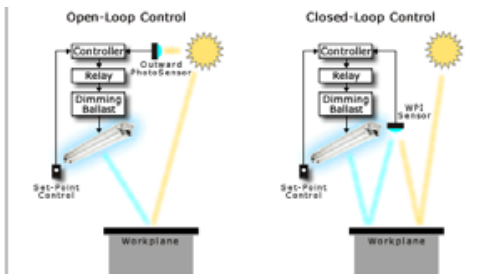

Figure 2: Categories of automatic daylight harvesting lighting controls. Source: IntelliBlinds.

- Smart Lighting management using sensors

This measure involves the installation of motion sensors in railway stations which automatically trigger lighting when movement is detected and similarly, turns off lighting after a period when it detects no movement. Sensible design of the sensor's location can ensure that they do not unnecessarily activate the lighting when a train passes. Figure 4 shows the layout of a smart lighting management using sensors in a railway station.

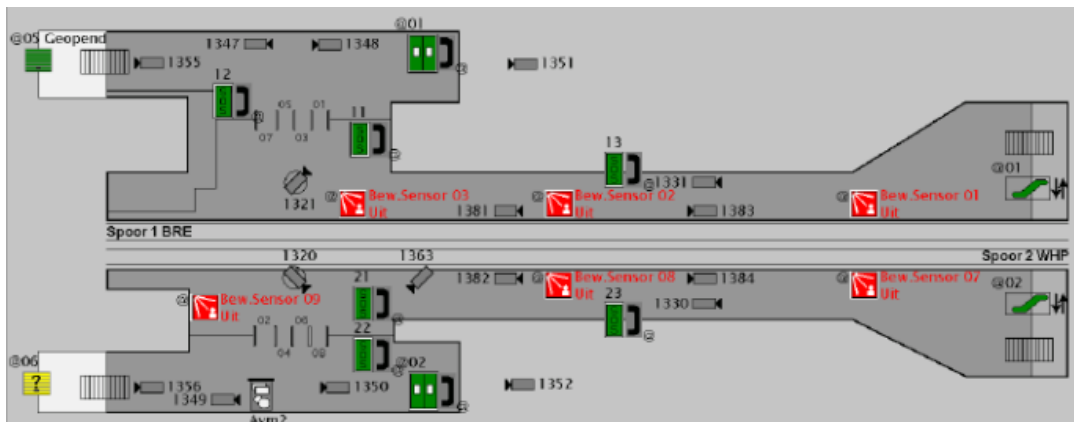

Figure 4: Layout of a smart lighting management using sensors in a railway station. Source: Ticket to Kyoto Project (2013).



Figure 3: Lighting's LED solution in Moscow Railway Station. Source: Moscow Railway Station (2014).

- LED technology or LED light bulb

A LED lamp is a solid-state lamp that uses light-emitting diodes (LEDs) as the source of light. It is more energy efficient than conventional lights (incandescent light bulbs and fluorescent lighting tubes). It has higher initial costs but also lower maintenance costs. Figure 3 shows the Lighting's LED solution in Moscow Railway Station.

Applications

Theoretical applications

Author	Explanation	Benefits
Guangzhou Railway Station (China)	The area of the waiting room in Guangzhou railway station is 7,020 m ² . There are about 1,297 energy-saving lamps and 818 fluorescent tubes in the room. Though the building uses a large number of energy-saving lamps, it is not enough, and the design and control system is unreasonable. It is necessary to choose a new type of energy-saving light source instead of fluorescent tubes, use intelligent lighting control system and improve the management and utilization of the system.	Changing conventional lighting system is an important measure to reduce the power consumption and optimize the quality of electricity, saving lighting electricity to achieve the best lighting effect.

Real applications. Demonstrator

Author	Explanation	Benefits
Dutch infrastructure manager ProRail	The intelligent lighting system developed by Dutch company Tvilight has been installed at Beilen station on the Zwolle-Groningen line and Hooerveen and Meppel stations. Each lamp is fitted with a motion sensor, which can detect the movement of passengers up to 20 m away. If a passenger is present, the light operates at full luminosity. The system also adjusts the level of light according to the ambient lighting conditions, meaning it uses less energy in good weather conditions.	The dimmer system can be fitted to existing lighting and savings from these three stations could cover the cost of the equipment within seven years, while reducing annual CO ₂ emissions by 17,600 kg.

Author	Explanation	Benefits
China Railway Corporation	There are some energy-saving measures that have been implemented in railway stations: <ul style="list-style-type: none"> • Implementation of LED technology and highly efficient fluorescent light. • Intelligent lighting controls. 	These measures increase lighting efficiency but depend on quality: many low-quality products on the market undermine the opportunity. The investment can be returned in less than 1 year, although complicated control programs may take 3 years. The productivity increases.

Bibliography

- Jaarsma, A. et al. (2013). WP 2: Saving energy in metro and light rail stations. Workgroup Energy Efficiency. Consultants in Sustainable Mobility, December 2013.
- Barrow, K. (2013). ProRail trials intelligent station lighting. International Railway Journal. December 2013.
- Fu, K. et al. (2009). Current Situation of Energy Consumption in Guangzhou Railway Station and Analysis on the Potential of Energy Conservation. School of Mechanical Engineering. Southwest Jiaotong University. China.
- Jiang, Y. (2005). Current building energy consumption in China and effective energy efficiency measures. HVAC, 35(5): 30-31.
- Improving energy efficiency and reducing emissions through intelligent railway station buildings. Asian development bank, 2015.

3.2.3. Escalators

Introduction

Efficiency

Escalators equipped with Variable Speed Drives (VSD) or equivalent systems that allow regulating their speed depending on the load increase the efficiency of this equipment. Energy saving potential is about 30% compared to an escalator which is operating continuously at maximum speed.

Investment

The investment of modifying existing escalators with VSD or equivalent systems depends on several factors, and there is a wide range of prices for this kind of equipment. Therefore, the assessment of the investment cost of applying this measure should be carried out on a case-by-case basis.

Scope of the technology

- ➔ An escalator equipped with Variable Speed Drive (VSD) may achieve an energy consumption reduction of 30% on average.
- ➔ An additional PFU device (or an escalator equipped with an asynchronous induction motor) also allows regenerating energy when operating downwards.
- ➔ Different alternatives have been developed in order to reduce the energy consumption, such as:
 - Variable Voltage Constant Speed Drive (VVC)
 - Variable Speed Drive (VSD)
 - Power Feedback Unit (PFU)

Field of application

	Field 0	Field 1	Field 2	Field 3	Field 4	Field 5
Field of Application	Common measures to other sectors	Measures of train and track design	Efficient use of power traction	Optimization of operations	Use of the regenerated energy	Interaction between electricity networks
Escalators						
		Design Measures		Redesign Measures		Operation Measures

Technology analysis

Railway stations are one of the key elements of a railway network. They tend to be massive structures with high energy consumption, high occupancy rates and often in operation 24 hours a day. Although air conditioning systems account for more than 50% of their total energy expenditure in stations (Yi Jiang, 2005), other elements require also a noteworthy amount of energy.

Escalators are an essential element in many stations, particularly in larger ones with high occupancy where big flows of passengers require easy and comfortable access to the premises.

Nowadays there are more than 15,000 escalators installed in public transportation facilities (train stations, airports, etc.) in the EU27.

Their annual energy consumption ranges from 4,000 to 10,000 kWh per year depending on their configuration and degree of use (Almeida et al. 2012).

The energy consumed by an escalator depends on several factors such as the rise between landings, the angle of inclination and the rated speed (Carrillo et al. 2013). Nevertheless, up to 70% of the total energy consumption is a fixed value, i.e. energy used by the unloaded escalator to overcome friction. The remaining 30% is variable and depends on the load (Ma et al. 2009). Therefore, there is an evident potential for energy saving by acting on the fixed consumption, when the escalator is unloaded.

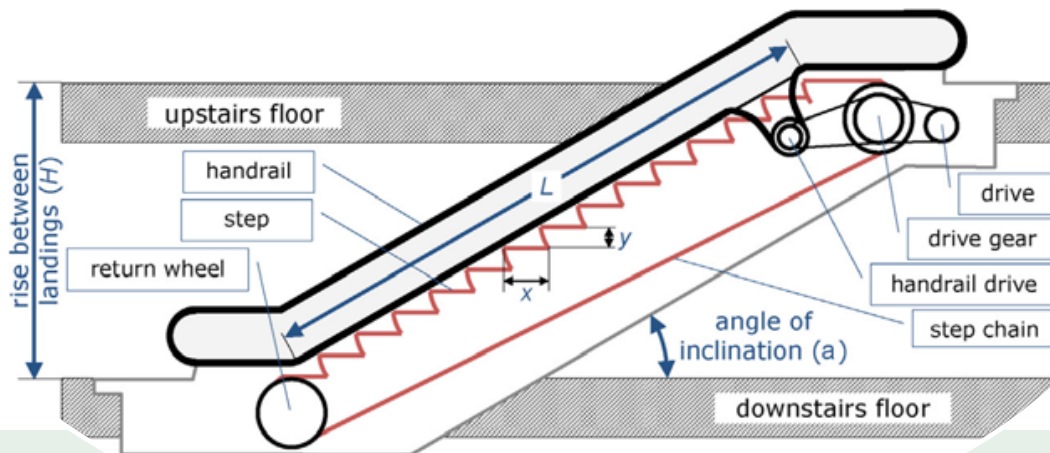

Figure 1: Escalator scheme. Source: Carrillo et al. (2013).

Different alternatives have been developed, such as:

- Variable Voltage Constant Speed Drive (VVC): A device that regulates the motor voltage to improve its power factor when fewer or no people are using the escalator. The speed is kept constant.
- Variable Speed Drive (VSD): A device that regulates the speed depending on the load. This is the most broadly used option.
- Power Feedback Unit (PFU). A device that regenerates energy from downwards running escalators when the load exceeds a predefined threshold, although certain types of motors (asynchronous squirrel cage induction motors) provide this capability without the need for specific devices.

Objectives and benefits

Among the options used to reduce the energy consumption of escalators, speed control is the most broadly applied due to its effectiveness. Usually escalators work at a predefined rated speed, which ranges from 0.5 to 0.75 m/s depending on the design parameters. However, the flow of people using a train facility is not constant, but fluctuates along the day and escalators work unloaded during significant periods of time (longer or smaller depending on the occupancy of the specific station).

A variable speed device detects when the escalator is unloaded and, after a brief delay (usually of 10 seconds), reduces the speed to a lower value (e.g. 0.2 m/s) or even stops the escalator completely.

By carefully adjusting the parameters of the VSD, it is possible to save up to 30% of energy, compared to an escalator that works continually at normal speed (Carrillo et al. 2013).

The precise reduction of energy consumption depends on many factors such as the flow of people, degree of maintenance, etc. Some experiences (Casals et al. 2016) have measured an energy reduction of 8.5% by defining a two speed levels system: normal (0.5 m/s) and low (0.2 m/s). However, other applications have achieved an energy consumption reduction of about 50%, particularly in escalators with low traffic conditions.

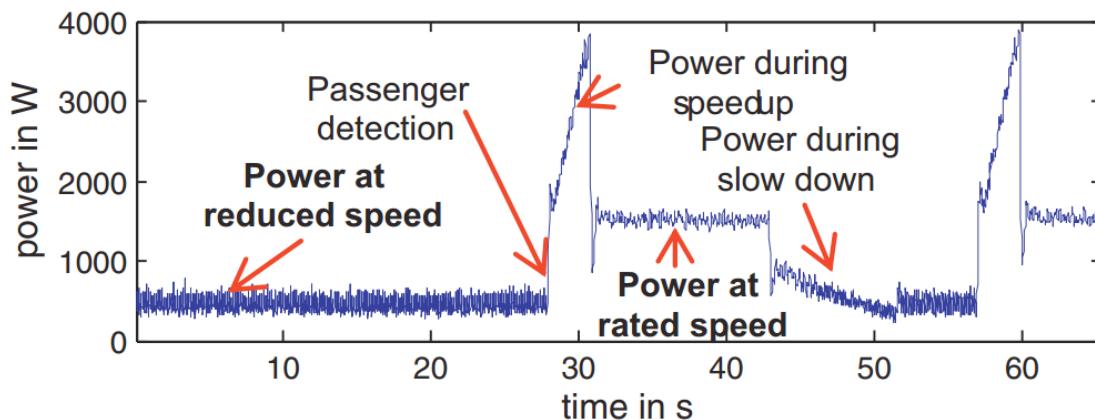

Figure 2: Power consumed by an escalator with two speed modes. Source: Carrillo et al. (2013).

Applications

Theoretical applications

Author	Explanation	Benefits
Casals et al. 2016	The authors of this paper developed an intelligent energy management system and applied it to a prototype underground station. The model took into account several elements such as ventilation, lightning and escalators.	The escalators of the defined prototype station operated with two speed levels (0.5 and 0.2 m/s). This was modified to a three-level scheme (0.5, 0.4 and full stop), achieving a reduction of energy consumption of about 8.5%.

Real applications. Demonstrator

Author	Explanation	Benefits
Singapore's Rapid Transit System	Escalators in the RTS in Singapore are equipped with an inverter system that reduces the speed from 0.75 m/s to 0.2 m/s when the escalator operates at no load. During longer unloading periods, the system stops the escalator completely.	By adjusting the speed of the escalator depending on the load, energy savings of up to 30% are achieved, compared to escalators operated continuously at maximum speed.

Bibliography

- Yi Jiang. (2005). Current building energy consumption in China and effective energy efficiency measures. HVAC, 2005, 35(5): 30-31.
- Carrillo, C. et al. (2013). A methodology for energy analysis of escalators. Energy and Buildings, 61: 21-30.
- Casals, M. (2016). SEAM4US: An intelligent energy management system for underground stations. Applied Energy, 166: 150-164.
- Uimonen, S. et al. (2016). Energy consumption of escalators in low traffic environment. Energy and Buildings, 125: 287-297.
- Almeida, A. et al. (2012). Energy-efficient elevators and escalators in Europe: An analysis of energy efficiency potentials and policy measures. Energy and Buildings, 47: 151-158.
- Ma, W. et al. (2009). Research on the waiting time of passengers and escalator energy consumption at the railway station. Energy and Buildings, 41: 1313-1318.
- Thong, M. et al. (2012). Energy Efficiency in Singapore's Rapid Transit System. Journeys May 2012.

3.3. Infrastructure ancillary systems

3.3.1. Heating points

3.3.1. Heating points

Introduction

Efficiency

Heating points is a necessity to ensure proper operation of rail switches in cold climates. By introducing newer heaters with improved insulation and regulation (thermostats, monitoring and control), their energy expenditure may be reduced significantly. Another alternative is to power such systems with geothermal energy harvested near the track, hence cutting down the need for external power supply.

Investment

The investment cost of newer heaters with better insulation and thermostats is relatively low, and such systems are designed to be durable and require low maintenance. Installing a system to harvest geothermal energy requires higher investment costs, but this can be compensated in a few years with the cost of the energy saved.

Scope of the measure

- ➔ More efficient point heaters, powered partially with geothermal energy, may achieve a significant reduction of energy consumption. Theoretical calculations under several operational scenarios have yield an average energy saving of 30% compared to conventional heaters
- ➔ Heaters may be powered totally or partially with geothermal energy, which is a source of renewable energy.
- ➔ As part of the energy may be provided from geothermal sources, the ratio of CO₂ per kWh consumed is reduced.
- ➔ More efficient point heaters affect the location of emissions at local level consider than the energy could be geothermal.

Field of application

	Field 0	Field 1	Field 2	Field 3	Field 4	Field 5
Field of Application	Common measures to other sectors	Measures of train and track design	Efficient use of power traction	Optimization of operations	Use of the regenerated energy	Interaction between electricity networks
Heating points						
		Design Measures		Redesign Measures		Operation Measures

Technology analysis

Railway switches are essential elements of a railway network. These mechanical installations regulate track junctions and diversions and their reliability is critical to ensure safe railway transportation. Railway tracks are mostly outdoors, and thus are exposed to adverse weather. In colder climates such as the ones found in Northern Europe, low temperatures and snowfall are quite common during part of the year. Snow tends to accumulate over the track and may block the switch mechanism, hence hampering its normal operation. Even without snow, below-zero temperatures may cause frost in the point that moves the blades to fix stock rail or support slide plates, thus blocking the switch.



Figure 1: Railway switch with gas heater. Source: Fabian Grunder. Wikipedia Commons.

In order to avoid this problem, railway switches in cold climates are equipped with heaters that keep the temperature of the rails and other elements over a fixed threshold so as to melt any snow and frost accumulated and to ensure a smooth operation.

A point heating system should be able to perform in light winds and maintain the rail temperature above a predefined temperature against a minimum ambient temperature (e.g. 3°C against -25°C according to UK regulations). The system should perform three functions (Heat Trace):

- Prevent the moving switch rail from freezing to the fixed stock rail.
- Prevent the switch rail from freezing to the support slide plates.
- Prevent any build of snow, sleet or hail between the switch rail and the stock rail that could compact and prevent the point system from operating correctly.

The importance of such systems in cold climates is highlighted by the following table, where the some average data regarding snow and low temperatures is shown (UK annual average for the 1981-2010 period).

Event	Average number of days per year
Ground frost	>100
Sleet/ snow falling	South: 20-30 / North 50-60
Sleet/ snow lying	South: 20-30 / North 50-60

Table 1: Average number of days per year with cold events in the UK. Source: Met Office.

The impact of such systems in the overall energy expenditure of a railway infrastructure may be noticeable. For instance, a heating system for a single switch which operates continuously during cold months (i.e. from October to April) may require up to 34,000 kWh per year, or about 28,000 kWh if it is equipped with a thermostat (Eltherm).

Considering a whole railway network, the amount of energy needed to power these systems is significant. In Germany, Deutsche Bahn (DB) alone has 64,000 points heated with electrical resistance and gas heaters, a combined power of 900 MW which consume up to 230 GWh/year (BINE).

Objetives and benefits

Most conventional points heaters are either electrical resistances or gas heaters. Over the past years some improvements and variations have been researched and tested so as to increase their energy efficiency. The main issue with conventional heaters is that only a fraction of the energy is actually consumed to heat up the rail or other track elements, while the rest is lost as waste heat. In order to solve this, the main focus of most modern heater designs is to improve their insulation and ensure that most of the heat generated goes into the rails.



Figure 2: Railway switch equipped with electrical heater. Source: railway-technology.com.

On the other hand, traditional heaters operated on an on/off basis i.e. they turned on as soon as the temperature fell below a defined threshold and worked at full power until the room temperature rose again. Newer heaters are equipped with thermostats or even controlled through a centralized network so that they adapt their workload depending on the actual temperature.

The combination of better insulation and regulation increases significantly the energy efficiency of heaters. Many new commercial designs guarantee improvements ranging from 10% to even 80% with regards to traditional heaters, depending on different factors. The next table shows a summary of average energy savings for different scenarios compared to the energy consumption of a traditional heater with ON/OFF operation.

Scenarios	Average energy saving vs case 1
1. Conventional heater, ON/OFF operation	0
2. Better insulated heater ON/OFF operation	8%
3. Better insulated heater, thermostat	30%
4. Better insulated, thermostat, monitoring and control	70%

Table 2: Energy savings for different scenarios. Source: Elaborated from various authors.

In addition to the aforementioned measures, another alternative has been evaluated over the past few years. Under certain conditions, it is possible to harvest geothermal energy from the underground and use to power heaters, either partially or even completely, thus reducing the need for external power supply.

This alternative has been already tested with different prototypes in several locations with promising results. The investment costs are higher than for conventional heaters due to the additional equipment required (heat pipes, boreholes, condensers) but this can be compensated in a few years as the heaters require very low (or even any) external energy supply.

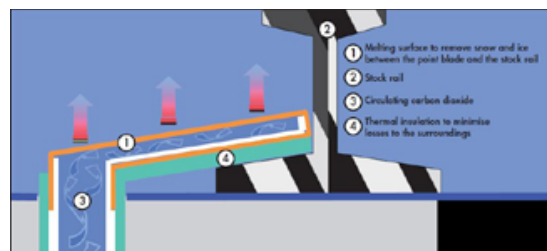

Figure 3: Scheme of a rail heated with geothermal energy. Source: BINE.

Applications

Theoretical applications

Author	Explanation	Benefits
Eltherm GmbH	This company has developed new points heaters with improved insulation and regulation.	Theoretical calculations under several operational scenarios have yielded an average energy saving of 30% compared to conventional heaters. This accounts for an average reduction of 17.3 tonnes of CO ₂ per switch and year.

Real applications. Demonstrator

Author	Explanation	Benefits
German Federal Ministry of Economics and Technology PINTSCH ABEN geotherm GmbH Bavarian Centre for Applied Energy Research	A research project developed to make further progress in point heaters powered completely with geothermal energy. Experimental prototypes have been tested under real conditions.	Geothermal powered heaters do not require external energy sources, hence cutting energy costs to zero. Higher investment cost compared to conventional heaters, but compensated after 8-10 years of use.

Bibliography

- Eltherm GmbH (2016). Railway Heating Systems. Innovations in heat tracing (brochure). Available at: <http://eltherm.com/355/rail-and-point-heating> (accessed 19/07/2016).
- Heat Trace Ltd (2016). A Guide to Rail Network Heat Tracing Applications. Available at: <http://www.heat-trace.co.uk/> (accessed 19/07/2016).
- BINE (2010). Projektinfo. Geothermal heating for railway points. Available at: <http://www.bine.info/en/publications/publikation/weichenheizung-mit-erdwaerme/> (accessed 20/07/2016).
- UK Met Office. Climate data for the period 1981-2010. Available at: <http://www.metoffice.gov.uk/public/weather/climate> (accessed 20/07/2016).

Source: Gonzalo Rubio



4. Energy management

4.1. Eco-driving

4.1.1. Driving strategies

4.1.2. Driving Advisory Systems
(DAS)

4.1.1. Driving strategies

Introduction

Efficiency

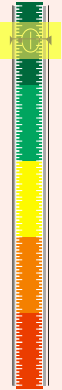

The efficiency of this measure is given by finding the sweet spot between travel time and energy consumption, performing an economic and environmental friendly driving.

Investment

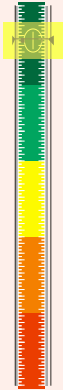

For this measure, the necessary investment can be translated into an increase of the travel time but it does not involve any economical cost. Additional costs, which could be associated with the ones of teaching the drivers how to drive in an economical and friendly environmental way, could be added.

Scope of the measure

- ➔ There are a lot of benefits in an Eco-driving strategies with and without regenerative brake, coasting and driving limiting the maximum speed reduces the energy and the CO₂ emissions. There is a reduction in the energy consumption between 8% and 22%.
- ➔ This should lead to important savings in terms of CO₂ emissions, an annual 0.15 Mton CO₂ emission avoidance through the drivers training.

Field of application

	Field 0	Field 1	Field 2	Field 3	Field 4	Field 5
Field of Application	Common measures to other sectors	Measures of train and track design	Efficient use of power traction	Optimization of operations	Use of the regenerated energy	Interaction between electricity networks
Driving strategies						
		Design Measures		Redesign Measures		Operation Measures

Measure analysis

How trains are driven (and regulate its operation) can involve a significant impact on energy consumption.

“Eco-drive” is a way to drive the train that allows a lower energy consumption rather than driving at “full speed” or “minimum driving time”, which implies driving at the maximum allowed speeds on each point.

Normally, timetables are built calculating, for each journey, the shortest time strategy in first place. This strategy has the following characteristics:

- Full acceleration up to maximum speed.
- Speed holding at maximum speed until the train has to start braking.
- Braking at the latest possible point in order to come to stop when reaching the station.

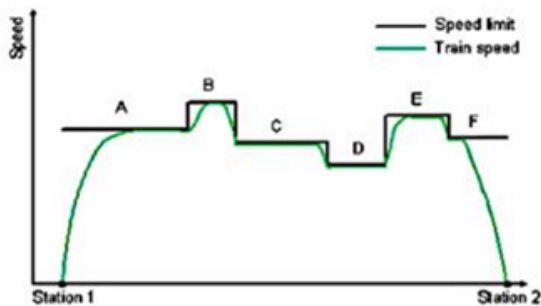

Figure 1. Shortest time driving strategy (hypothetical example). Source: Salvador, P. (2008).

It is important to understand that a shortest time strategy (as the one show in figure 1) is very energy consuming, so it should be avoided as long as possible.

There are many possible driving strategies that can lead to the same travel time with different consumption. Thus, the most appropriate would be the one in which for the same time given the minimum consumption is achieved.

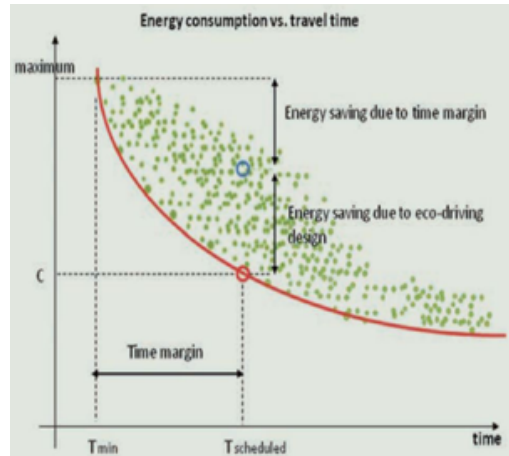

Figure 2. Relationship between travel time and energy consumption. Source: Cucala García, P et al. (2013).

Figure 2 shows the result of consumptions and travel times in a certain route. In the scatter plot is possible to see:

- The general trend is the longer the travel times, the lower energy consumption.

- For each travel time there are several possible energy consumption rates depending on the driving strategy.

- There is a Pareto optimal curve in each path between stations, which provides the minimum consumption for each travel time.

- The Pareto optimal curve has a form of descending parabola. This means that small increases in travel time allow relatively significant reductions in energy consumption. On the other hand, the strategy rooted on large increases in travel time, will produce small reductions in consumption.

Having a time frame in which the amount of time between the minimum time that the train needs to travel a certain distance and the time available is a necessary condition. In this way, the driving style will have an impact on energy consumption.

Regarding Eco-driving, the driving strategies between two stations or stopping points may be the followings:

1. Limiting the maximum speed.
2. Accelerate the utmost, keep maximum speed and reduce speed by coasting before each of the points where it is necessary to slow down.
3. The third one is the same as the previous strategy, with the application of coasting just until a speed higher than the necessary to stop is reached, called, “minimum speed drift”, below which the service brake is applied to slow down.
4. Accelerating as much as possible, then do coasting to loose some speed and after that accelerate again to recover the maximum speed and so on (coasting-remotor).

Objectives and benefits I/II

Achieving maximum efficiency depends on the driving strategy chosen by the driver. Each route and service should be studied in detail, but there are some generic strategy advices that can help reduce energy consumption, for both Eco-driving, with and without regenerative brake:

- Accelerate the utmost.
- Coasting (using kinetic energy to overcome the drag). This is especially suitable for high speeds in which the time losses during the coasting are reduced, and the drag is very high. By contrast, at low speeds coasting supposes wasting time with little energy reduction. For this reason an intuitive driving economic criteria could be to use only drift above a certain speed, below which the service brake is used.
- Coasting-remotor. Sometimes, when the speed profile is homogeneous, this strategy at high speeds is used. It implies coasting after reaching the maximum speed, leaving the train at drift until a specific speed, from which traction is reapplied, is the best strategy. Applying several coasting-remotor cycles, instead of a single drift at the end of the route or upon arrival of a stop, may be more beneficial, due to the drift is performed at a higher speed and therefore losses in travel times are lower.
- The strategy of limiting the maximum speed is based on traveling at a slower speed in order to reduce the drag, but as the previous strategy, it finds its maximum application at high speeds.
- Coasting before reaching the starting point of a downhill, in order to prevent braking on it (mainly in steep slopes) and avoiding dissipating energy in brakes. In this case an efficient strategy would be to allow trains to exceed the maximum speed on downhill slopes (obviously without exceeding the safety limits).

In addition, it is necessary to highlight that driving strategies are radically different when the trains are equipped with regenerative brake and the regenerated energy can be used, compared to those performed by trains without regenerative brake or compared with those in which the percentage of energy returned to the catenary is low. It is very important to emphasize this because there is a general trend to implement Eco-driving strategies designed for services which do not have regenerative brake or with low use of it in services which has it and vice versa. For example, strategies based on coasting have interest when there is not a high use of regenerative brake or the energy generated in the regenerative brake is lost, as otherwise it is not possible to use it either on the same train, either by other train, or returning the energy to the grid.

On the other hand, in case of having regenerative brake, the most appropriate strategy would be limiting top speeds, except in steeper downhill slopes, in order to reduce the drag, and applying the regenerative brake in each stop and speed limitation. Another possibility to perform Eco-driving strategies is to accelerate at maximum speed, do a shorter coasting, and then brake as much as possible, in order to take full advantage of the recovered energy. The following figures show the different Eco-driving strategies and/or a combination of them explained:

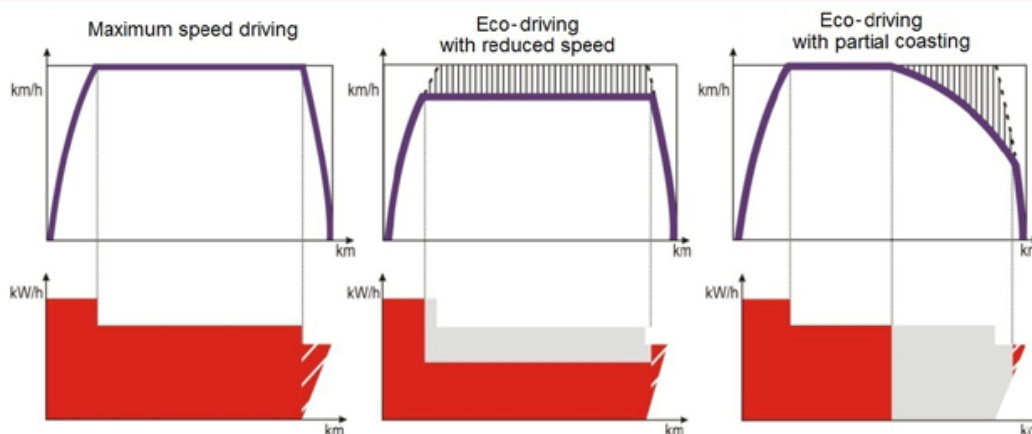

Figure 3a: Different driving strategies. Source: García, A. (2016).

Objectives and benefits II/II

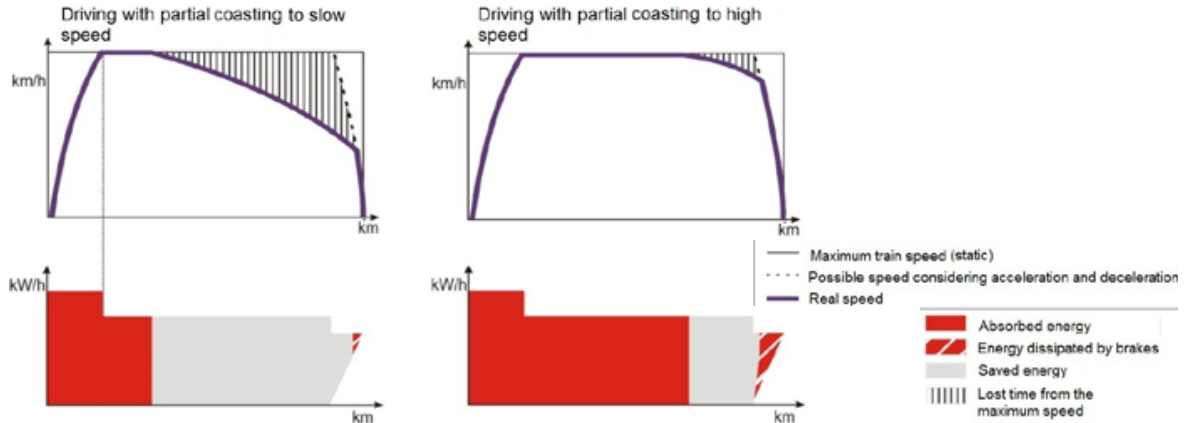

Figure 3b: Different driving strategies. Source: Garcia, A. (2016).

In the following pictures some other benefits in energy optimization as a result of implementing an energy Eco-driving strategies in a Czech Republic railway line. The graphics show the increments of times that are necessary to perform an Eco-drive strategy and the associated energy reductions.

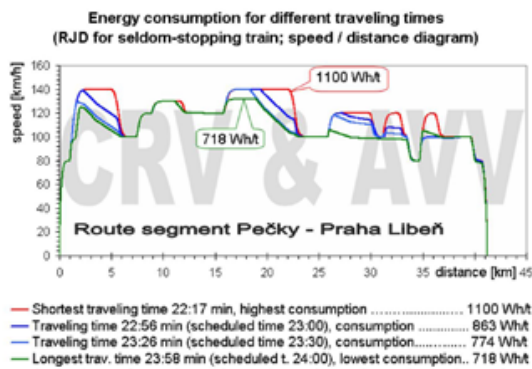

Figure 4: Energy consumption for different travel times I. Source: Salvador, P. (2008).

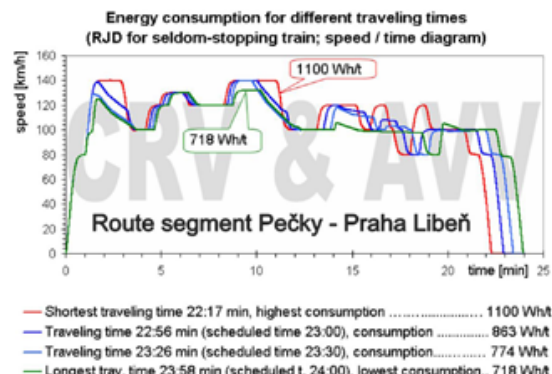

Figure 5: Energy consumption for different travel times II. Source: Salvador, P. (2008).

The data from the last example allows calculating the elasticity of energy over time, giving the values that are shown in table 1.

Travelling time (hh:mm:ss)	Energy cosumed (Wh/t)	Elasticity	Elasticity (%)
0:22:17	1110		
0:22:56	863	-738	62%
0:23:26	774	-574	26%
0:23:58	718	-459	71%

Table 1: Elasticity for energy over time. Source: Salvador, P. (2008).

As it can be seen, a slight increase of travelling time can produce a significant reduction on energy consumption. For example, in the case shown in a Czech Republic railway line, increasing travelling time only 1min and 41s, means a relative increment of 7.6%, energy which can be lowered down to 2/3 of its initial value. This means that if time tables allow buffers, which don't need to be very significant, a great saving of energy can be achieved, and the train would still run on time.

Applications

Real applications. Demonstrators

Author	Explanation	Benefits
Europe: Netherlands, Slovenia, Slovakia, Italy, Greece	Many Eco-driving programs are being developed in different European countries to teach drivers how to do the best ecological and economical driving. TRAINER is a program that was developed and implemented to streamline measures of enhancing energy efficiency by railway operators.	The results of the TRAINER program in 2009, were an annual 0.15 Mton CO ₂ emission avoidance through the training of 19,500 train drivers.
Author	Explanation	Benefits
Renfe, Spain	A simulator has been the tool of this experience which took place in the Madrid-Seville line. By manipulating the simulator, the drivers were urged to improve consumption. This driving simulator considered aspects of coasting, reduced the maximum speed and reduced acceleration.	The results in the simulation were very satisfactory with an energy reduction between 10% and 20%.
Author	Explanation	Benefits
Renfe, Spain	After teaching drivers how to do an Eco-driving with the simulation tool a real experience driving on that line, Madrid-Sevilla has allowed to observe that with a five minutes increase in the travel time, a reduction in energy consumption is suitable, due to the possibility to perform coasting approximately trough sixty percent of the journey.	A real reduction of 8%, has been proved in the Madrid-Sevilla line.
Author	Explanation	Benefits
Comboios de Portugal	A model studies the Eco-driving based on the energy-efficient drivings state of art applied to railways. The studies of the model developed, evaluate the differences between actual driving ways with efficient driving strategies.	The results obtained in the evaluation of the model developed for comparing actual driving with efficient driving strategies, indicate a potential of energy savings up to 15%.
Author	Explanation	Benefits
Salvador, P. (2008)	He explains the influence of trains' energy consumption in the Lötschberg line (Switzerland), which, before drivers were instructed, energy consumption for Bern-Thun section was 373 kWh, while for the same trip with an economic driving after those Eco-driving programs, energy value reached 305 kWh.	A real application demonstrated that driving in an economic way can save 22% of the energy consumed in traction.

Bibliography

- García, A. (2016). Energía y emisiones en el transporte por ferrocarril. Fundación de los Ferrocarriles Españoles. Madrid (Spain).
- Grabocka, J. et al. Realistic Optimal Policies For Energy-Efficient Train Driving. University of Hildesheim (Germany).
- Monteiro, J. N. (2014). Condução Energeticamente Eficiente na Exploração Ferroviária em Portugal Aplicação ao caso dos serviços regionais na linha do Douro. Lisbon (Portugal).
- Cucala, P. et al. (2013). Reducción del consumo energético en el ferrocarril. Anales de mecánica y electricidad (38-41) July - August 2013. Madrid (Spain).
- Salvador, P. (2008). Estrategias para el ahorro de energía en la explotación ferroviaria. Universidad Politecnica de Valencia. Valencia (Spain).
- Scheepmaker, G. M. et al. (2015). Effect of regenerative braking on energy-efficient train control. Delft (The Netherlands).

4.1.2. Driving Advisory Systems

Introduction

Efficiency

The use of Driving Advisory Systems (DAS), allowing a better performance of driving, under all operational situations. The system may tell drivers what to do in order to perform the optimal driving strategy in terms of energy efficiency. Energy cost and emissions can be reduced by up to 20%.

Investment

The investment costs are low and could be amortized between 2-5 years. Furthermore, with the implementation of a DAS, the vehicle running costs have a significant reduction.

Scope of the technology

- ➔ Energy costs and emissions reduced by up to 20%.
- ➔ Improved on-time running and pacing of trains, optionally integrated with existing timetable and speed restriction systems. On-time arrivals improved by 10%.
- ➔ Reduction in braking by up to 30%, or more, leading to reduced maintenance costs.
- ➔ Improved operations management and options to integrate with existing Business Intelligence systems.

Field of application

	Field 0	Field 1	Field 2	Field 3	Field 4	Field 5
Field of Application	Common measures to other sectors	Measures of train and track design	Efficient use of power traction	Optimization of operations	Use of the regenerated energy	Interaction between electricity networks
Driving advisory system						
		Design Measures		Redesign Measures		Operation Measures

Technology analysis I/II

Driving Advisory Systems (DAS) are on board tools giving recommendations to drivers towards a more energy efficient driving style. The DAS represents a human-machine interface (HMI) which supports the exchange of information between the railway system and the human operator (the driver). The human operator needs to process the information received, and produce instructions or control actions.

This software has many different versions and may tell drivers what to do in every moment in order to perform the optimal drive in terms of energy-efficiency. The instructions that are given to the drivers are:

- Acceleration rate to apply.
- Optimal train speed for each instant.
- Exact moment for shutting power down and start coasting.
- Exact time for applying train brakes, and braking rate.

The outlined architecture and interfaces for a generic DAS can be seen in figure 1.

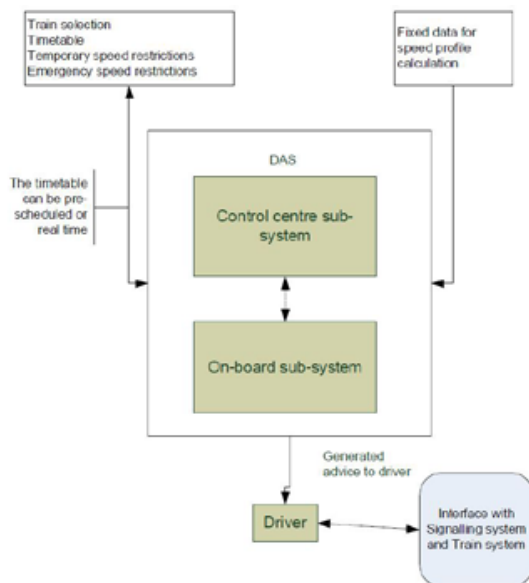

Figure 1. DAS architecture DAS. Source Jianhong Jin et al. (2011).

The on-board system calculates an energy efficient speed profile to achieve the pre-planned or dynamically updated train timings, and generates detailed driver advice to follow the profile and achieve the travel schedule. This architecture allows optimises running to a pre-defined timetable, without a real time data link between the train and control centre.

According to this, energy efficiency can be improved because a DAS can calculate the optimal ride between two stations better than train drivers taking into account the state of the signalling, the maximum speeds and the railway layout.

With the drivers training it is possible to reduce energy consumption, due to the driving performance improvement. Furthermore, what a Driving Advisory System improves regarding experienced trained drivers is that DAS are aware of the traffic situation, which makes them to be able to drive in conflictive situations while keeping energy consumption in minimum levels.

The data that the Driving Advisory Systems need can be grouped in four types, according to its needed frequency:

- Permanent data: Vehicle data.
- Long-term data: Track data base (to be updated annually).
- Mid-term data: Time table.
- Short-term data: Data on temporary low-speed sections (to be updated daily or even in real-time).

Figure 1 and 2 show an example of a two trains in conflictive situation with a necessary stop or speed reduction, without and with a Driver Advisory System.

Figure 1 shows the unplanned situation without a Driver Advisory in which the energy consumption is 350 kWh in a runtime of 651 sec (incl. unplanned stop).

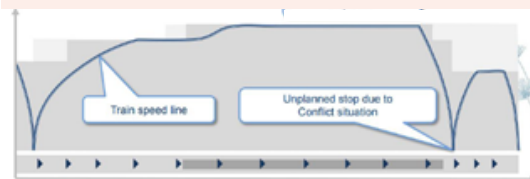

Figure 2. Train route: Gelterkinden-Olten. Source Trümpi, A. (2014).

Figure 2 shows the unplanned situation with a Driver Advisory in which the energy consumption is 204 kWh in a runtime of 626 sec, which implies the that there is a 40% of energy consumption and a 25 sec train runtime saved.

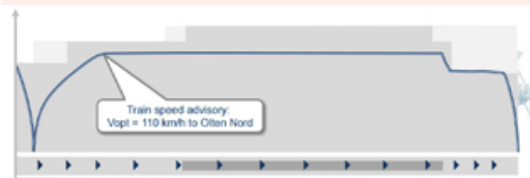
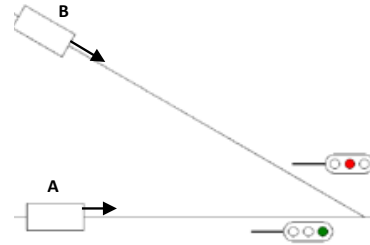

Figure 3. Train route: Gelterkinden-Olten with DAS. Source Trümpi, A. (2014).

Technology analysis II/II

As an example, the following comparison in a railway node is shown, by using a Driver Advisory System and without using it, in which Train A should reach the crossing at 8:00 and train B at 8:05.



DAS implemented

1) 8:00 h. Train A has a 5 minutes delay, but still has preference over train B. The DAS tells to train B to drive slow enough to reach the crossing after 8:06 h.

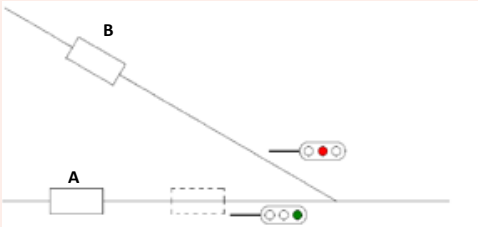

2) 8:05 h. Train A reaches the crossing. Train B still is not there

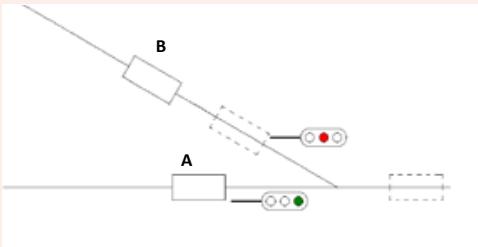

3) 8:07 h. Train B reaches the crossing by the time the light signal turns on green, so it doesn't need to stop and later accelerate.

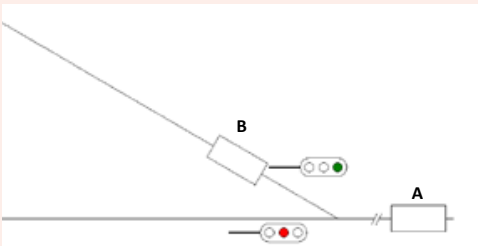

D A S not implemented

1) 8:00 h. Train A has a 5 minutes delay, but still has preference over train B.

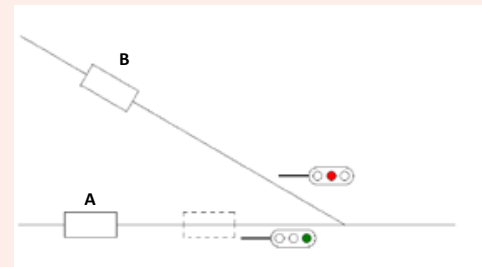

2) 8:05 h. Train A and B reach the crossing. Train B must stop at the red signal.

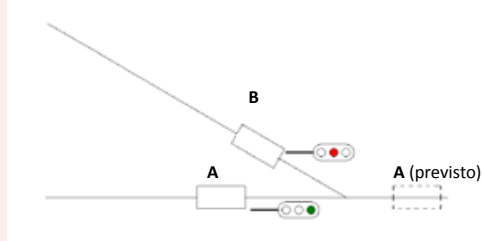

3) 8:07 h. Signal is now free for train B, which needs to restart its running.

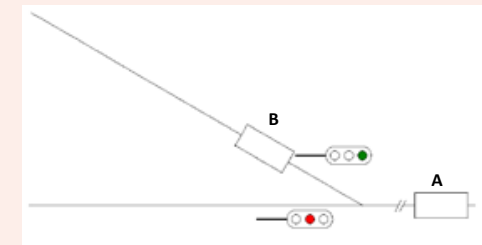

Figure 4a, 4b, 4c, 4d, 4e, 4f and 4g. DAS behaviour. Source Salvador, P (2008).

Objectives and benefits

A Driving Advisory System can be used to manage the speed profile of each train to extend the running time to incorporate the unused allowances, so that the train arrives at the station or junction at exactly the right time. This will allow energy savings in the following circumstances:

- When a train delay due to the actual temporary speed restrictions on the route is less than the engineering allowance.
 - When a train is running on time and the performance and pathing margin are not required to achieve on-time arrival.
 - When a train is capable of shorter point to point timings than those used in the timetable planning.
- The benefits from implementation of a Driver Advisory System (DAS) include reductions in energy consumption by avoiding unnecessary braking and running at reduced speed whilst maintaining on-time arrival. Operational benefits include reduced train delays and better utilisation of track capacity by running through junctions and station approaches at higher speeds whilst reducing maintenance costs as a result of reduced brake wear. There are also potential safety improvements through fewer red signals approached if the DAS is effectively implemented across the network.

Table 1 shows the Benefit to Cost Ratio (BCR) considering a range of train installation costs and service life over which the equipment will be operated. There are 3 basis cases in which the initial cost are higher according to the quality of the DAS. From table 1 it can be concluded that there is a positive business case in all cases except for the highest installation cost option on the shortest life of rolling stock.

Fitment option \ over		10 years	20 years	30 years
Cab based:	Low	2.3	2.7	2.8
	Medium	1.3	1.8	2.0
	High	0.8	1.2	1.4

Table 1: BCR for fitment options over different periods. Source Jianhong Jin et al. (2011).

The key findings from the simulations for energy savings can be seen in the table below (Table 2).

Energy Savings from DAS					
		Typically Perturbed Timetable (95% confidence interval)		Unperturbed Timetable	
		No Energy Recovered	90% of Braking Energy Recovered	No Energy Recovered	90% of Braking Energy Recovered
Individual Train DAS		14.36% ± 0.53%	8.42% ± 0.33%	26.68%	15.15%

Table 2: Simulation results - energy savings from DAS. Source Jianhong Jin et al. (2011).

From table 2 it can be concluded that, assuming no energy recoverable, DASs save over 14% of energy in typical line peak timetable operation, and over 26% of energy in ideal unperturbed operation of the same timetable. If 90% of the energy lost through braking is recoverable, then the energy savings are still over 8% and 15% for typically perturbed and unperturbed timetable operation respectively.

For the safety performance, the simulation results have shown that DAS reduces red signal sightings by around 11% in typical line morning peak timetable operation, and by over 22% in ideal unperturbed operation of the same timetable.

Applications

Real applications. Demonstrators

Author	Explanation	Benefits
LEADER Knorr-Bremse	It calculates train behaviours on the basis of rolling stock and infrastructure data and energy efficient driving strategies for the train drivers.	<ul style="list-style-type: none"> • Reduce energy consumption. • Reduce the in-train forces. • Provide optimal driving advisory strategies.
MetroMiser Siemens, Germany	This system makes a timetable energy optimizer and it has an on-board unit to calculate and provide optimal driving advisory information.	Provide energy efficient driving with energy optimized timetables.
FreightMiser TTG Australia	This type of DAS for freight trains calculates optimal speed with different journey time, optimal coasting points during the journey and provides the information to the drivers.	<ul style="list-style-type: none"> • Improve energy consumption. • Improve punctuality of freight rail.
GEKKO DSB Denmark	This system is implemented with a PDA device which request timetable and infrastructure information to calculate optimal speed profiles for the drivers.	Indicate drivers to be on correct pathway.
AVV AZD, Czech Republic	This type of DAS is able to reduce train speed or stops the train in accordance with absolute speed limits, signal indications and timetabled station stops.	Save energy using advanced train control.
Driving Style Manager (DSM) Bombardier	It produces an energy-optimised driving style (EODS) with the consideration of temporary or dynamic speed indications and signalling information.	Advise drivers about speed, acceleration and deceleration to minimise the energy consumption.

Biography

- Trümpi, A. (2014). Conflict handling and fluent traffic sbb traffic system. UIC energy efficiency days June 2014, Antwerpen (Belgium).
- Panou, K et al. (2013). Railway Driver Advisory Systems: Evaluation of Methods, Tools and Systems. 13th WCTR, July 15-18, 2013 - Rio de Janeiro (Brazil).
- Ghys, S. (2016). Optimising the world's railways an Australian technology perspective. Australasian Railway Association Telecommunications & Technology Forum. 14 & 15 July 2016. Melbourne (Australia).
- Salvador, P. (2008). Estrategias para el ahorro de energía en la explotación ferroviaria. Universidad Politecnica de Valencia. Valencia (Spain).
- UIC Website for Energy Efficiency Technologies for Railways.
- <http://www.ttgtransportationtechnology.com/energymiser/>
- Jianhong Jin, et al. (2011). Driver Advisory Information for Energy Management and Regulation. RSSB (UK).
- Panou, K. et al. (2013). Railway driver advisory systems: evaluation of methods, tools and systems. 13th WCTR, July 15-18, 2013 - Rio de Janeiro (Brazil).

4.2. Energy storage systems

4.2.1. Flywheels

4.2.2. Supercapacitors

4.2.3. Batteries

4.2.1. Flywheels

Introduction

Efficiency

The energy savings result from an increase in the use of the energy generated in the regenerative brake. There is a potential for modern flywheels to save 10-15% of energy consumption when installed on traditional rolling stock.

Additional benefits can be achieved by reducing a 30% substation peak power.

Investment

The investment cost is higher than traditional power systems or batteries for energy storage (although costs calculated on a lifetime basis are lower). However the energy savings achieved (fuel savings for diesel vehicles) imply that the period of time required to recoup the investment may be shorter (between 5.1 and 13.9 years) depending on the capacity of the system installed.

Scope of the technology

- ➔ Tests demonstrate that energy storage saves about 24% of the total energy consumption.
- ➔ This technology can reduce the power peaks a 30%.
- ➔ This technology reduces noise and it may offer cleaner air in stations and workshops.
- ➔ The energy savings achieved imply that the period of time required to recoup the investment may last between 5 and 14 years.

Field of application

	Field 0	Field 1	Field 2	Field 3	Field 4	Field 5
Field of Application	Common measures to other sectors	Measures of train and track design	Efficient use of power traction	Optimization of operations	Use of the regenerated energy	Interaction between electricity networks
Flywheels						
		Design Measures		Redesign Measures		Operation Measures

Technology analysis

Fly-wheel is an electro-mechanical energy storage system based on rotating masses. It consists of a rotary cylindrical mass (consisting of a wheel coupled to an axle) which is mounted on a common shaft by bearings in magnetic levitation, which eliminates bearing wear and increases the system life.

In order to maintain efficiency, the “fly-wheel” system operates in a vacuum chamber that reduces drag. The fly-wheel is connected to a motor-generator assembled on the stator, through power electronics, which interacts with the grid (see figure 1).

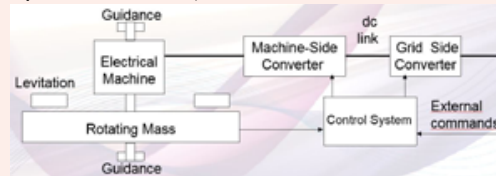

Figure 1. Flywheel scheme. Source: Lafoz, M. (2015).

A Fly-wheel is based on a simple principle: Store energy in a rotating mass which is driven by an electrical machine. This machine exchanges power with the grid through two power converters connected through a DC-link.

The fly-wheel system consists of the following main components:

- **Rotor:** Since the stored energy is proportional to the rotor mass and to the square of the rotational speed, the rotor needs to combine high mass and high speed tolerance. The rotor of state-of-the-art fly-wheels is a hollow cylinder primarily made of steel (between 200 and 375 m/s de maximum speed) or carbon fibre composite (600 to 1000 m/s of maximum speed). Advantages of this material (as compared to steel rotors) lie in its tearing stability allowing much higher rotation speeds and its favourable crashing behaviour saving difficult protection measures. Drawbacks of carbon fibre composites are: relatively small mass (limiting storing capacity since energy content is proportional to mass) and difficult manufacturing process.

- **Bearings and vacuum housing:** In order to minimize bearing friction, most of the rotor weight can come from magnetic forces. The rotor housing is evacuated, thus minimizing air friction losses. In some fly-wheels inert gases are used instead of a vacuum.

- **Motor/generator unit:** For an optimum compact system design the motor/generator (M/G) unit is integrated inside the hollow rotor.

Figure 2, shows, as an example, a generic fly-wheel storage system with its different components identified.

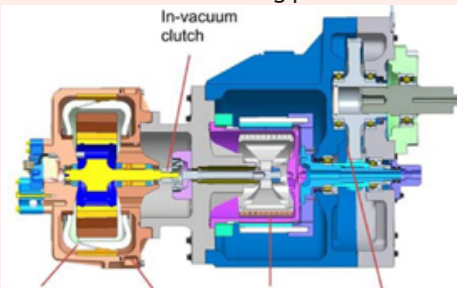

Figure 2. Section of flywheel assembly (for test ring). Source: Wheals, J. C. et al. (2015).

Main characteristics of the system:

1. Power density is high.
2. Power and energy are independent.
3. Continuous operation is possible. Very high number of cycles.
4. Fast response and overload capacity.
5. Not very high thermal dependant.
6. No modification of vehicles is required.

7. The technology is cost-effective when there is large scale applications.

Fly-wheel storage system is a powerful tool which may be used in on-board diesel-electric vehicles, to store braking energy, on-board DC systems to raise recuperation rate and Stationary DC systems to raise recuperation rate.

The size and the weight are the reason why external fly-wheel systems are more useful on electrified railways to help regulate the voltage of the line through reducing power demands during acceleration. Figure 3 shows the scheme of an external fly-wheel situation.

Despite of this, fly-wheel trams exist in two primary forms: hybrid and zero-emissions: (i) Hybrid fly-wheel trams run on the kinetic energy stored in their fly-wheels to power the trains during acceleration and then recharge the fly-wheels when braking. (ii) Zero-emissions fly-wheel trams rely solely on the kinetic energy stored in their fly-wheels which are recharged at stations and stopping points. These stopping points must be relatively close together (<0.5miles in some cases) for this technology to be viable as a stand-alone system.

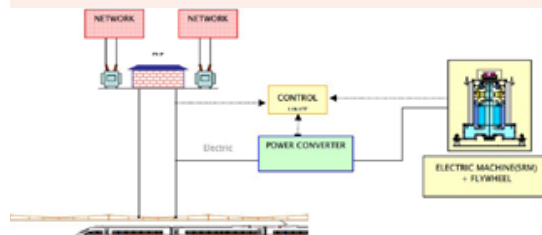

Figure 3. Schematic of the kinetic energy storage system and its implementation in a real track. Source: Iglesias, I. J.

Objectives and benefits

Fly-wheels are characterized by:

- Releasing and absorbing energy very efficiently and quickly;
- Wide temperature operating range;
- Can last 20 years or longer with minimal service requirements;
- Flexible sizing and installation into both new lines and retrofits;
- Can be installed in parallel operation and with other technologies for greater power conservation and regeneration;
 - Provides significant energy savings and emissions reductions.

Regarding electric vehicles, the main objective of this technology is to become DC and AC systems more “receptive” by storing energy until it is needed by other trains. In this case, the goal is to use the electricity coming from the regenerative brake that cannot be used by another train or returned to the grid and is converted into heat in the braking resistors. Additionally, this technology may help to stabilize the DC voltage at the power line and reduce substation power peaks.

Regarding diesel vehicles the use of storage fly-wheels should firstly reduce the costs (LCC) of operating diesel-propelled vehicles, and secondly it should further improve the environmental compatibility of these vehicles. Both targets are achieved by the reduced consumption of diesel fuel; the emission of pollutants and CO₂ are reduced. In addition, this type of systems may reduce noise and may offer a cleaner air in stations and workshops.

Flywheel systems have been used in a number of transport-related technologies, mostly on a trial basis. Many recent studies have pointed out the potential for modern flywheels to save 10-15% of energy consumption when installed on traditional rolling stock (see figure 4).

The investment cost is much higher than traditional power systems or batteries for energy storage (although costs calculated on a lifetime basis are lower), however the energy savings achieved (fuel savings for diesel vehicles) imply that the period of time required to recoup the funds expended may be shorter (between 5.1 and 13.9 years) depending on the capacity of the system installed. The study of Wheals, J. C. et al. (2015) develop a payback model aiming to quantify the commercial advantages of a fly-wheel stored system installed in a DMU in a specific scenario (see Table 1).

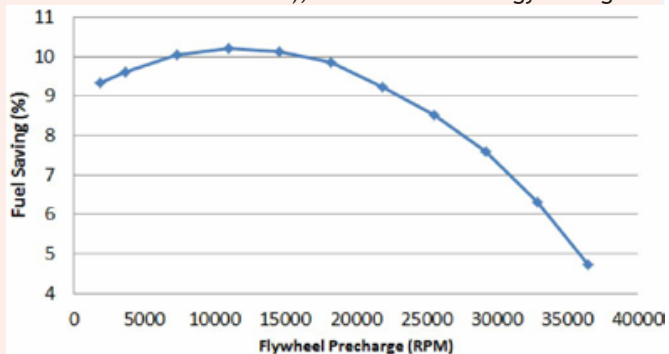

Figure 4: Effect of fly-wheel pre-charge on fuel savings. Source: Wheals, J. C. et al. (2015).

Flywheel Capacity [MJ]	Hybrid Launch Speed [mph]	Mean Trans Efficiency []	Cost Installed [£k]	Payback [years]
1	13.02	0.2	25	13.9
2	18.42	0.325	27	11.1
3	22.56	0.375	30	8.7
4.5	27.6	0.4	35	6.6
9	37.07	0.425	40	3.5
9	37.07	0.425	50	4.6
9	37.07	0.425	60	5.53
13.5	47.8	0.5	72	5.1

Table 1: Payback projection according to fly-wheel capacity. Source: Wheals, J. C. et al. (2015).

Applications I/II

Theoretical applications. Demonstrators

Author	Explanation	Benefits
Witthuhn, M. F. Hoerl (2001)	Comprehensive theoretical studies and simulations have been carried out, in conjunction with Alstom LHB, Deutsche Bahn AG, which plans to test a system with storage fly-wheels on the LIREX ® test carrier.	This simulation showed an energy saving potential of about 11% for a vehicle with storage fly-wheels compared with a similar vehicle without storage fly-wheels. In general, the results obtained, showed that the use of storage fly-wheels in vehicles produced the greatest advantage particularly on routes with relatively short distances between stations.

Author	Explanation	Benefits
Wheels, J. C. et al. (2015)	The study measures the efficiency with which a hydraulic system can transfer energy to a fly-wheel on its approach to a station, the ability of the fly-wheel to maintain its state-of-charge whilst the train dwells in a station, and the efficiency of converting stored energy to vehicle motion during pull-away from the station. A payback model is also presented quantifying the commercial advantages and challenges that sustain the business case analysed.	The study shows that a total of 9 MJ comprising two 4.5 MJ units provides a payback of 4.6 years with annual savings of £13k/DMU for stop-start commuter routes.

Real applications. Demonstrators

Author	Explanation	Benefits
Piller-Powerbridge	The German company Piller has developed a flywheel energy storage system for the rail transport sector. The Powerbridge storage system consists of the kinetic energy storage unit and the interface between the unit and the contact wire.	The system has been installed in Hannover in 2004 and the results achieved in this pilot project amounted to 462.000 kWh saved annually and energy costs reduced by 40.000€ per year (80€/Mwh).

Author	Explanation	Benefits
Gunselmann W., Höschler P., Reiner, G. (2000)	Since 2000 a flywheel storage system with a maximum energy content of 6,6 kWh and a maximum power of 600 kW was installed in a substation of the DC supply grid in the Cologne local transportation network.	Tests demonstrate that energy storage saves about 24% of the total energy consumption. Additional cost savings are achieved due to power peaks reduction.

Author	Explanation	Benefits
Kinetic Traction- GTR SYSTEMS	KINETIC TRACTION (formerly PENTADYNE) has developed carbon fibre flywheels (GTR system) to store energy regenerated during braking. The GTR system is a 200 kW high cycling flywheel energy storage system featuring a high speed composite rotor running on frictionless bearings requiring no maintenance. It has an available energy saving potential of 1.5 kWh.	New York MTA selected KINETIC TRACTION to provide an improved version of a demonstration flywheel system, which was successfully tested on the Far Rockaway line in 2002. Unfortunately the project was stopped due to budget constraints.

Applications II/II

Author	Explanation	Benefits
Adif	The Energy Storage System (SA2VE) project aims at using the braking energy of trains, which is not used by other trains on the network and therefore is dissipated in braking resistances.	The savings could reach values of up to 20% of energy consume. SA2VE project makes a more uniform consumption profile, reducing substation elements and supply penalties.

Bibliography

- Witthuhn, M. et al. (2001): Applications for energy storage flywheels in vehicles of Deutsche Bahn AG. Proceedings of the World Congress of Railway Research WCRR 2001, Cologne (Germany).
- King, C et al. (2015). Innovative Technologies for Light Rail and Tram: A European reference resource Briefing Paper 9 Kinetic Power - Flywheel System September 2015.
- Wheals, J. C. Rail Hybrid using Flywheel. Ricardo (UK).
- Estévez, P. et al. (2008). Sistemas de almacenamiento de energía eléctrica embarcados en los trenes. Elecrail Monografía 4. Fundación de los Ferrocarriles Españoles. Madrid (Spain).
- Lafoz, M. (2015). Nuevos enfoques tecnológicos para el almacenamiento de energía. Jornada Técnica de la PTFE: Gestión energética sostenible e inteligente en el ámbito ferroviario. March 2015. Madrid (Spain).
- Wheals, J. C. et al. (2015). Viable flywheel system for rail (UK).
- <http://www.railway-technology.com/news/newsalstom-use-williams-flywheel-energy-storage-technology-citadis-trams>
- Gunselmann W. et al. (2000): Energiespeichereinsatz im Statbahnnetz Köln. Elektrische Bahnen 98 (2000) z. 11-12. Cologne (Germany).
- Iglesias, I. J. et al. A Kinetic Energy Storage System for Railways Applications. ADIF. Railways Infrastructure Manager, CEDEX Studies and Experimentation Centre of Public Works and Transportation (Fomento) Ministry, CIEMAT Centre for Energy, Environment and Technology Research, Madrid (Spain).
- Adif (2016). 2 Eficiencia energetica.

4.2.2. Supercapacitors

Introduction

Efficiency

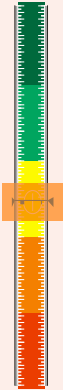

The energy savings result from an increase in the use of the energy generated by the regenerative brake.

This technology can help to achieve energy savings of up to 30% in public transportation and can reduce the power peak up to 50%.

Investment

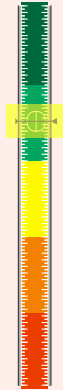

The period of time to recover the investment (between 100.000€ and 200.000€) may vary between 2-5 years.

Scope of the measure

- ➔ Energy storage system operationally for around 22 hours per day could reduce the annual primary energy demand by as much as 500,000 kWh. That may lead to a reduction of CO₂ emission of 300 tons.
- ➔ Energy savings are between 10% and 30% and the required power peak at the substation is reduced by 50%.
- ➔ The system improves network stability.
- ➔ The system has autonomy without catenary.
- ➔ The cost of installing the equipment could be recovered within 2-5 years.

Field of application

	Field 0	Field 1	Field 2	Field 3	Field 4	Field 5
Field of Application	Common measures to other sectors	Measures of train and track design	Efficient use of power traction	Optimization of operations	Use of the regenerated energy	Interaction between electricity networks
Supercap.						
		Design Measures		Redesign Measures		Operation Measures

Technology analysis

Electrochemical double layer capacitors (EDLC), also commonly known as Ultracapacitors (UC) or Supercapacitors (SC), store energy via electrostatic field. The energy is stored by charge transfer at the boundary between electrode and electrolyte. Despite it is an electrochemical device there are no chemical reactions involved in its energy storage mechanism. It is constituted of two electrodes, a separator and an electrolyte. The electrodes are made-up of activated carbon particles strongly packed, which provide a high surface area responsible for energy density acting as polarizable electrodes. The two electrodes are separated by a membrane (separator), which allows the mobility of charged ions and forbids electronic contact (see figure 1).

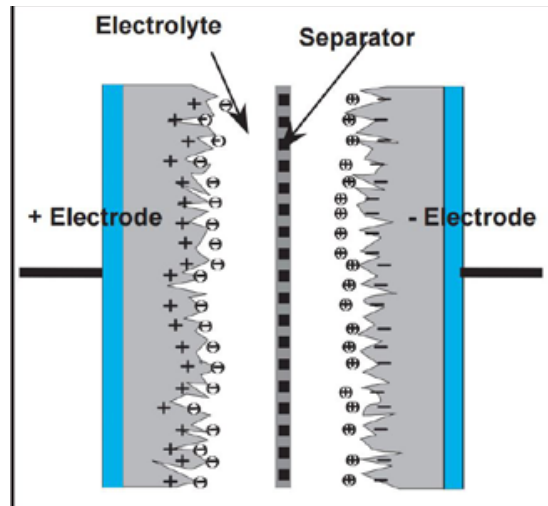

Figure 1. Ultracapacitor Charge Separation. Source: Maher, B et al. (2006).

A supercapacitor can be viewed as two non-reactive porous plates suspended within an electrolyte with an applied voltage across the plates. The applied potential on the positive plate attracts the negative ions in the electrolyte, while the potential on the negative plate attracts the positive ions. This effectively creates two layers of capacitive storage, one where the charges are separated at the positive plate, and another at the negative plate.

A supercapacitor is made of porous carbon materials. The electrolyte can be either aqueous or organic. Aqueous electrolyte has lower energy density due to less stress, but are cheaper and operate in a higher temperature range. Asymmetric supercapacitors, which use a metal in one of the electrodes, have a significantly higher energy density than symmetric, and also a lower leakage current. The porous structure of this material allows its surface area, much greater than conventional capacitors. A supercapacitor's charge separation distance is determined by the size of the ions in the electrolyte, which are attracted to the charged electrode.

The combination of the capacitance depends directly on the size and extremely small charge separation, and it normally lies in the range of several thousand farads. Supercapacitors are also able to deliver high power over short periods, which is another attractive feature for transportation applications.

According to this, these devices exhibit relatively low energy densities but high power densities, with discharge times ranging from seconds to minutes, high efficiency (around 95%), larger current charge and/or discharge capacity, long life cycle and low heating losses. Other advantages of supercapacitors are long life with little degradation, which makes the device environmentally friendly, good reversibility, improved safety and simple charge methods. Conversely, disadvantages include significant self-discharge, low maximum voltage, rapid voltage drop and spark hazard when shorted. The resulting characteristic suggests their utilization for supplying power peaks, for energy recovery, and for

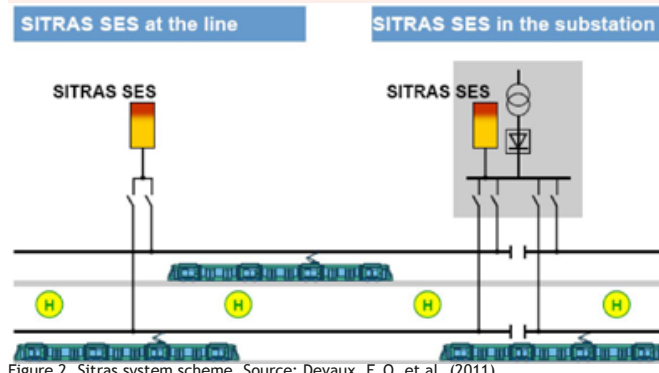

Figure 2. Sitras system scheme. Source: Devaux, F. O. et al. (2011).

compensating quickly voltage variations.

Objectives and benefits

Supercapacitor technology is characterized by the following:

- It can release and absorb energy very efficiently and quickly.
- It performs well in cold weather, down to -40°C .
- It is safe, as a pack is easily discharged overnight or for immediate maintenance.
- It has a long life cycle, virtually unlimited cycle life, can be cycled millions of time.
- It charges in seconds, no end-of-charge termination required and have a simple charging.
- It is 85% to 95% efficient.
- It is environmentally friendly, as they are 70% recyclable and do not include heavy metals.
- It has high specific power, low resistance enables high load currents.
- It provides significant energy savings and emissions reductions.
- It has no chemical reactions.
- It can not be overloaded.
- Possibility of catenary free operation of vehicles.

Regarding electric vehicles, the main objective of this technology is to become DC and AC systems more “receptive” by storing energy until it is needed by other trains. In this case, the goal is to use the electricity coming from the regenerative brake that cannot be used for another train or returned to the grid and is converted into heat in the braking resistors. Additionally, this technology may help to stabilize the DC voltage at the power line and reduce substation power peak.

As an example, the SITRAS SES system has delivered energy savings of up to 30% and has reduced the peak power required from the network by 50%, leading to typical cost savings estimated in millions of Euros, while improving network stability. Figure 3 show the energy consumption before and after this system was installed. The energy consumption resulting 320.000kWh and 500.000kWh less and potential reductions of 300 tons CO_2 emissions are expected on a yearly basis.

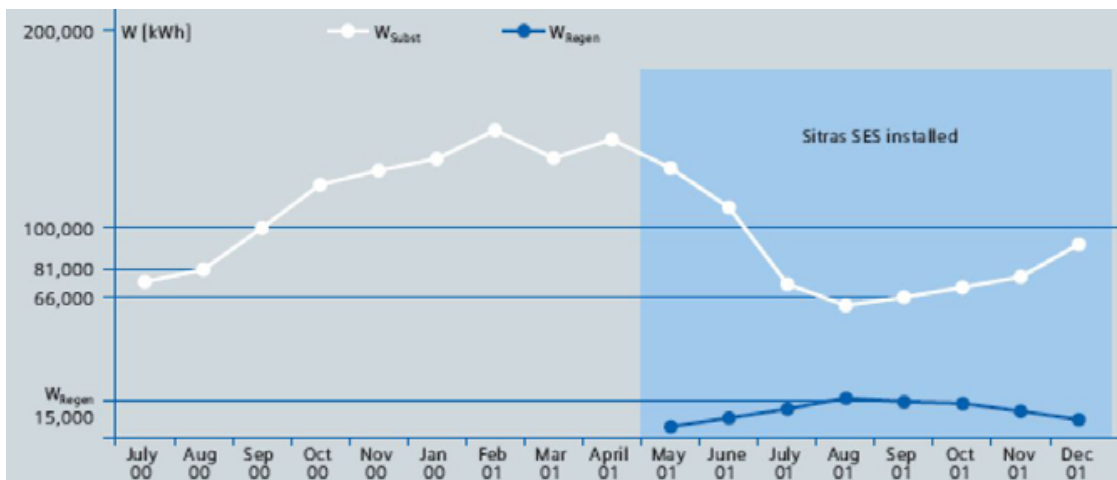

Figure 3: Energy consumption before and after the use of the SITRAS SES. Wilde, J. L. (2011).

Applications

Real applications. Demonstrators

Author	Explanation	Benefits
The Sitras SES (Stationary Energy Storage System)	It is an energy storage system based on supercapacitors and installed on land that stores energy from braking vehicles that are fed by the catenary connected to Sitras and provides power during the power peaks. This system is being implemented in several cities like Cologne, Madrid and Portland.	This is an economic and ecological combination as it reduces energy consumption at the catenary up to 30% and also CO ₂ emissions. On the other hand, it stabilizes the catenary and minimizes maintenance costs. The estimated energy savings per hour is: 80 kWh/h.
The Adetel group	Has developed the NeoGreen Power system based on supercapacitors and for use in railway applications in energy saving or voltage stabilizing mode. The system offers a storage modularity by storage branches: every branch includes its own storage, conversion, monitoring and control.	It enables to save energy and reduce the power peaks.
CAF (Urbos-2 LRV for Seville)	Developed the ACR system which is an on-board energy storage system based on the use of supercapacitors. The supercapacitors are charged in 20 seconds while the train is stopped at a station. The system can store both the braking energy and the energy received from the grid.	It enables trams to run between stops without catenary (1.200 m), as well as to save energy through the full regeneration of braking energy.
ALSTOM and Paris transport operator RATP	Launched in July 2009 a trial phase for a supercapacitors based on-board energy storage system. Developed under the STEEM (Système de Tramway à Efficacité Énergétique Maximisée) research and development project, this system has been mounted on the roof of one low-floor Citadis tram operating on tram route T3. A bank of 48 supercapacitor modules store the energy regenerated during the braking phases. The system can also be topped up from the overhead wire and recharged through the catenary in 20 seconds at stops.	It is estimated that the potential reduction in energy consumption could range up to 30%. It has autonomy without catenary.
MITRAC Energy Saver	Stores the energy recovered during braking in a bank of supercapacitors for later use during acceleration. In Mannheim, Germany, in a four years trial period saved approximately 30% of energy.	The system can reduce the catenary energy consumption by 30%, CO ₂ emissions between 25 and 30% and also it can reduce the power peak up to 50%, this implies that the current demand is reduced, so that fewer substations are needed, thus the infrastructure cost decreases.

Applications		
Author	Explanation	Benefits
SIEMENS - SITRAS HES (Lisbon's Metro South (MTS))	The HES system allows the vehicle to store braking energy and power drawn from the catenary and enables longer operations without overhead contact lines as both the supercapacitors and batteries can be used in parallel to further enhance the energy saving capabilities. The system was installed on a MTS Siemens Combino Plus LRV, it charges in 20s. It runs independently for up to 2.5 km.	The test vehicle operated without overhead power supply on a 2.6% gradient with auxiliary power of 5 kW and a maximum speed of 30 km/h. This vehicle has operated 20.000 km in revenue service since November 2008 with almost 100% reliability, achieving an energy saving of 10.8% compared with the standard Combino Plus vehicles in the MTS fleet. Siemens says the system can reduce CO emissions by up to 80 tonnes per year.
Author	Explanation	Benefits
BOMBARDIER - EnerGstor - Wayside energy storage system	Developed a wayside energy storage system based on supercapacitors called EnerGstor. The EnerGstor is composed of different modules that can be placed in parallel and can be monitored by a remote system. The system is still at a prototype stage.	Besides recovering braking energy, the system can also reduce the peak demand and mitigate the voltage sags.
Author	Explanation	Benefits
National Korean railway research agency (KRRRI)	Has been trialling the use of lineside supercapacitor modules to store braking energy on the Seoul and New York metro networks. KRRRI has contracted Woojin Industrial Systems to manage the pilot project in Korea in 2008. The equipment has been tested at 750 V and 1.5 kV DC at a facility in Gyeongsan.	Initial tests suggest that the use of this stationary system could reduce overall energy consumption by 23,4% and would help stabilizing the voltage. If this reduction can be achieved in service operation, KRRRI claims that the cost of installing the equipment could be recovered within four years.

Bibliography

- Fei Lin et al. (2016). Control Strategies with Dynamic Threshold Adjustment for Supercapacitor Energy Storage System Considering the Train and Substation Characteristics in Urban Rail Transit. School of Electrical Engineering, Beijing Jiaotong University, Beijing (China).
- Swanson, J. et al. (2015). State of the Art in Light Rail Alternative Power Supplies. Light Rail Conference. November, 2015. Minnesota (USA).
- Devaux, F. O. et al. (2011). WP2B Energy recovery. Overview of braking energy recovery technologies in the public transport field. Ticket to Kyoto. Europe.
- Maher, B. (2006). Ultracapacitors Provide Cost and Energy Savings for Public Transportation Applications. Battery Power Products & Technology magazine. Volume 10, Issue 6. November/December 2006. Colorado (USA).
- Tihomir Cihak. Supercapacitors in power converter DC link A short overview of design and application issues. Zagreb (Croatia).
- Ciccarelli, F. (2014). Energy management and control strategies for the use of supercapacitors storage technologies in urban railway traction systems. University of Naples. Naples (Italy).
- Estévez, P. et al. (2008). Sistemas de almacenamiento de energía eléctrica embarcados en los trenes. Elecrail Monografía 4. Fundación de los Ferrocarriles Españoles. Madrid (Spain).

4.1.3. Batteries

Introduction

Efficiency

The efficiency of this measure comes up, essentially due to the use of an energy accumulator, in order to avoid the loss of the energy generated during the brake, which is not possible to use by other trains or returned to the catenary.

Braking energy is recuperated immediately and stored and it results in up to 15 % of energy savings.

Investment

Initial investment and maintenance costs are lowered, making the overall system highly competitive and efficient.

Scope of the technology

- ➔ High energy density (greater than ultracapacitors and flywheels).
- ➔ Very slow self-discharge.
- ➔ Storage of energy for long periods of time.
- ➔ Low power density.
- ➔ Short service life compared with ultracapacitors.
- ➔ Memory effect: supports fewer cycles of loading and unloading.
- ➔ Reduced lifetime.

Field of application

	Field 0	Field 1	Field 2	Field 3	Field 4	Field 5
Field of Application	Common measures to other sectors	Measures of train and track design	Efficient use of power traction	Optimization of operations	Use of the regenerated energy	Interaction between electricity networks
Batteries						
		Design Measures		Redesign Measures		Operation Measures

Technology analysis

Batteries are the most known energy storage device. And are devices that store electrical energy by electrochemical methods and, depending on the technology use the efficiency is higher. This cycle can be repeated a number of times. It is a secondary electric generator, i.e. a generator cannot function unless it was not provided previously by electricity which is called charging.

The operation of a battery is essentially based on a reversible chemical process, which is a process in which ideally its components are not consumed or lost, but merely chemically transformed into other, which in turn can return to the first state in the right circumstances. These circumstances are the closing of the external circuit, during discharge, and applying a current, also external, during loading.

The battery consists of three basic elements; the anode (negative terminal); the cathode (positive terminal); and the electrolyte, which allows the passage of electrons from one terminal to another. As current is drawn from the battery, electrons begin to circulate from the anode through the electrolyte to the cathode.

Figure 1 shows the basic configuration of a battery.

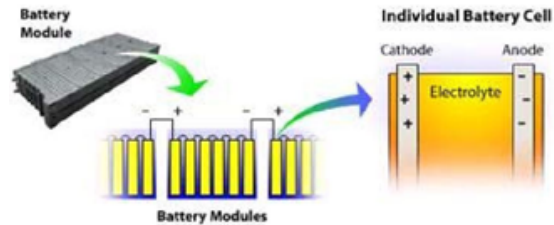

Figure 1: Basic configuration of a battery. Source: Estévez, P. et al. (2008).

The most relevant requirements posed on high-power batteries for transport applications are high power and energy densities. A high charge acceptance to maximize regenerative braking utilization, and long calendar and lifecycle, electric and thermal balance and recyclability are additional technological challenges.

In the following paragraphs some of the more relevant battery types are briefly presented.

- Lead acid batteries can be designed to be high power and are favoured by low price, high safety and reliability. There is a recycling infrastructure for lead acid batteries. Drawbacks are low energy densities, poor performance at low temperatures, and short lifecycle.

- Nickel-cadmium batteries are used in many electronic consumer products. They have higher specific energy and a better cycle life than lead acid batteries, but do not deliver sufficient power and are therefore not promising for braking energy storage.

- Nickel metal hydride batteries, used in computer and medical equipment, have good energy and power densities. Nickel metal hydride batteries have a much longer life cycle than lead acid batteries and are safe. Challenges of nickel metal hydride batteries are high prices, high self-discharge and heat generation at high temperatures, the need to control losses of hydrogen, and low cell efficiency.

- The lithium ion batteries are characterised by high energy density. Further benefits are high specific power, high energy efficiency, good performance at high temperatures, and low self-discharge. Recyclability is also accepted. These characteristics make lithium ion batteries suitable for braking energy storage.

- Lithium polymer batteries have the potential to provide the high specific power needed for braking energy storage. In addition, they are safe and have good lifecycle.

Figure 2 shows the operational steps of onboard battery powered tram.

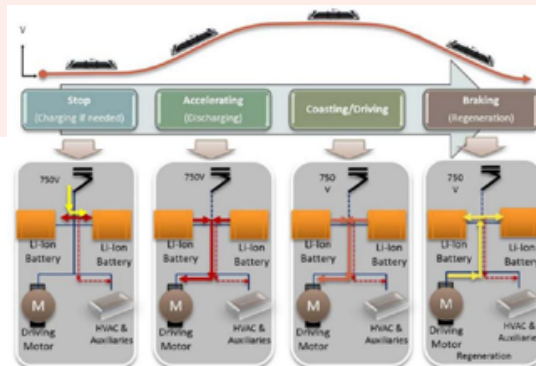

Figure 1 Operational steps of onboard battery-powered LRV

Figure 2: Operational steps of onboard battery powered tram. Source: King, C et al. (2015).

Objectives and benefits

Regarding electric vehicles, the main objective of this technology is to make DC and AC systems more “receptive” by storing energy until it is needed by other train. In this case, the goal is to use the electricity coming from the regenerative brake that cannot be used for another train or returned to the grid and is converted into heat in the braking resistors. Additionally, this technology may help to stabilize the DC voltage at the power line and reduce substation power peak.



Figure 3: PRIMOVE Li-ion Battery Case Study: Nanjing Tram Source: King, C et al. (2015).

Store the kinetic energy of braking (regenerative braking) and the advantage for autonomous operation without prolonged traction catenary and to contribute to the acceleration of the train in order to achieve greater energy efficiency.

- Reduce energy consumption, infrastructure costs and maintenance requirements so that a rapid return on investment is obtained.
- Ensure the safety and comfort of passengers during power failures; on board batteries are able to distribute enough emergency power to the auxiliary systems and autonomous power traction needed for the hybrid vehicle to continue the journey to the next station.
- Increase sustainable mobility facing a more livable future reducing fossil fuel consumption, noise from diesel engines and particulate emissions and betting on a transport model with a more attractive environmental approach.

Battery systems mentioned in this section have a higher energy density. However, its power density compared with the supercapacitors, is quite low.

Another general inconvenience of batteries is that the number of charge and discharge cycles it can withstand is less than the supercapacitors.

Furthermore, its useful life greatly depends on the depth of discharge cycles (each cycle energy consumed), so this causes a reduction in battery life.

Figure 4 shows a review of the different types of batteries which exist today.

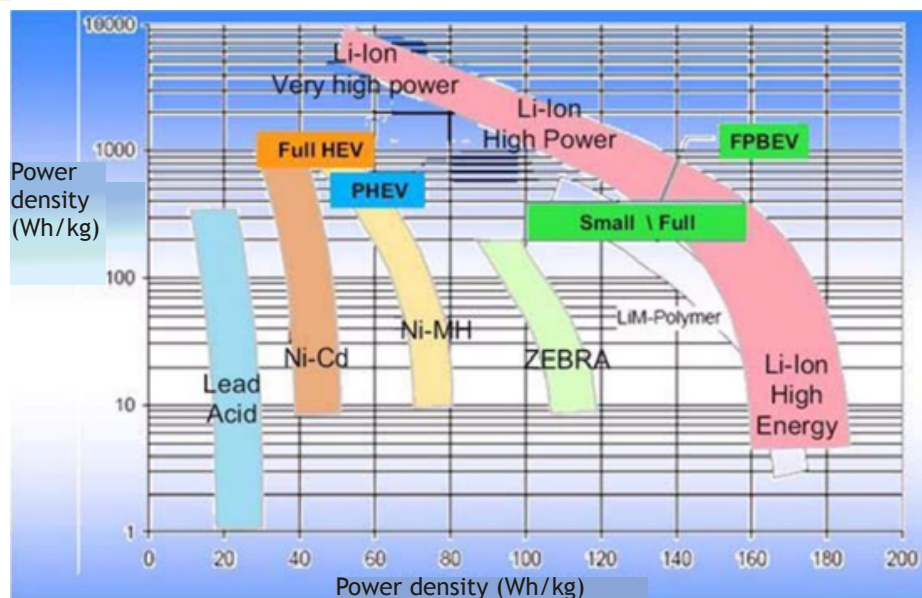

Figure 4: Relative power/energy density for different types of battery. Source: Estévez, P. et al. (2008).

Applications I/II

Real applications. Demonstrators

Author	Explanation	Benefits
ALSTOM Citadis tramway Nice (France)	This tram uses an autonomous Ni-Mh (nickel-metal hydride) battery on-board system. This system avoids the use of overhead contact lines over part of the route (11% of the line's 8.8 km) as the vehicle is able to switch its source of traction power between overhead catenaries and the on-board batteries for catenary-free operation.	The system helps to preserve the historical character of the city centre. Braking energy is recuperated immediately and stored and it results in up to 15 % of energy savings.
Kinki Sharyo for the US market	A prototype of the LFX-300 has been developed. The vehicle is 20 m long and 2 650 mm wide and is powered by four 120 kW motors. Using technology branded as 'e-Brid', the vehicle can operate by drawing power from overhead catenary or on-board lithium-ion batteries which store regenerated braking energy.	According to Kinki Sharyo International, the tram will be able to run for up to 8 km on battery power.
SAFT	SAFT is developing a prototype braking energy recovery system for railway applications consisting in sending the energy back to the electrical grid through reversible substations but adding a battery buffer for residual excess energy. The system is composed of Lithium-Ion battery pack of 7 kWh (230 V) that can be connected in parallel or in series.	It could save the exceeded energy which is not possible to return to the grid.
KAWASAKI	Has been testing its Swimo catenary-free light rail vehicle in the Japanese city of Sapporo. It uses Kawasaki Gigacell NiMH batteries, which can be fully charged in five minutes through the 600 V DC overhead catenary. This allows the vehicle to operate for up to 10 km on non-electrified lines under standard operating conditions. The system can also store energy from regenerative braking and use it for traction.	The system is catenary free and it could save energy due to the braking energy is recuperated immediately and stored or used.

Applications II/II

Author	Explanation	Benefits
National Infrastructure Commission	Engineers have received £1.5million in funding for a new battery energy storage project that could mean more efficient and cheaper trains. Engineers will study whether batteries from electric vehicles parked at train stations could supplement the system at busy periods. Commuters could receive free parking in return for their electric cars being used as back-up batteries, providing Road to Rail energy exchange.	The report has suggested that energy storage technologies could contribute to innovations that could save consumers up to £8 billion a year by 2030, help the UK meet its 2050 carbon targets, and secure the UK's energy supply for generations. The use of batteries will reduce the demand for electrical energy supply in these periods and could mean rail operators benefit from more efficient and frequent services. Passengers could in turn benefit from reduced costs and more train services.

Author	Explanation	Benefits
Kawasaki	Is manufacturing stationary battery systems for braking energy recovery and network voltage stabilization. The system is made of 20 modules offering different voltage configurations and may be placed in parallel.	In certain conditions, this system could replace a substation and it offers a good reliance in case of emergency as the high amount of energy stored in the modules would allow trains to move to the nearest stations when main power has failed.

Bibliography

- Saft (2014). Baterías ferroviarias de Saft Soluciones para un mundo en movimiento. 21843-3-0614. June 2014. Bagnolet (France).
- Bowen, K. (2016). Batteries from parked electric vehicles could reduce costs for train commuters April 19, 2016. University of Sheffield. Sheffield (UK).
- Caputo, L. (2000). Control of Energy Storage Device for Rail Vehicles. Department of Automatic Control Lund Institute of Technology September 2000, Lund (Sweden).
- Estévez, P. et al. (2008). Sistemas de almacenamiento de energía eléctrica embarcados en los trenes. Elecrail Monografía 4. Fundación de los Ferrocarriles Españoles. Madrid (Spain).
- Devaux, F. O. et al. (2011). WP2B Energy recovery. Overview of braking energy recovery technologies in the public transport field. Ticket to Kyoto. Europe.
- King, C et al. (2015). Innovative Technologies for Light Rail and Tram: A European reference resource Briefing Paper 9 Kinetic Power - Flywheel System September 2015.

4.3. Train operation

- 4.3.1. Timetable compatibility
- 4.3.2. Railway Smart Grids
- 4.3.3. Connected - DAS
- 4.3.4. Load factor
- 4.3.5. Metering devices

4.3.1. Timetable compatibility

Introduction

Efficiency

1. The overall efficiency of this measure depends on the available frame times to perform Eco-driving and the use of the regenerative brake.
2. The energy reductions obtained with the application of this measure were between 5% and 30%. Moreover, there is also a reduction of the power peak at substations (40%).

Investment

There is not investment cost for this measure, with the exception of the drivers training and the software necessary to do the optimal timetable.

Scope of the measure

- ➔ The benefits arise from the use of the regenerative brake and the performance of an economical drive, which allows energy reductions between 5% and 30%.
- ➔ Furthermore, there is a reduction in the power peaks at substations of up to 40%.
- ➔ A synchronized schedule could save 3% of energy at substations over time unsynchronized just with a one minute margin.

Field of application

	Field 0	Field 1	Field 2	Field 3	Field 4	Field 5
Field of Application	Common measures to other sectors	Measures of train and track design	Efficient use of power traction	Optimization of operations	Use of the regenerated energy	Interaction between electricity networks
Timetable compatibility						
		Design Measures		Redesign Measures		Operation Measures

Technology analysis

The design of schedules is a method whereby energy consumption can be reduced without additional cost, this makes this measure one of the best methods to reduce energy consumption. It is necessary to clarify that this measure does not work alone, actually the use of the regenerative brake is a crucial condition for any energy reduction.

There are three aspects that have to be taken into account to reduce energy consumption. The first one is related to the margins of regularity and their compatibility with Eco-driving; while the other two are related to the coincidence between departures, or between departures and arrivals at the same station.

(I) Frame times match with Eco-driving:

As explained in datasheet 4.1.1., doing an efficient and economical driving consists in taking full advantages of the degrees of freedom offered by the timetables (journey time) in order to reduce energy consumption.

Moreover, the train schedules need “regularly margins” to be more robust and reliable. As the margin of regularity is often larger than the one needed for Eco-driving margin, it is possible to leave a small amount of time for performing an Eco-driving strategy where there is no scheduling requirement, and distributing the rest of the frame time between the points that require punctuality. Another possibility is to reduce time at stops and adding the reduced time to the Eco-driving time frame.

(II) Avoiding simultaneous departures:

The several tracks of the same station are normally fed from the same substation, even in some cases several stations are fed by the same substation, as it can be seen in figure 1.

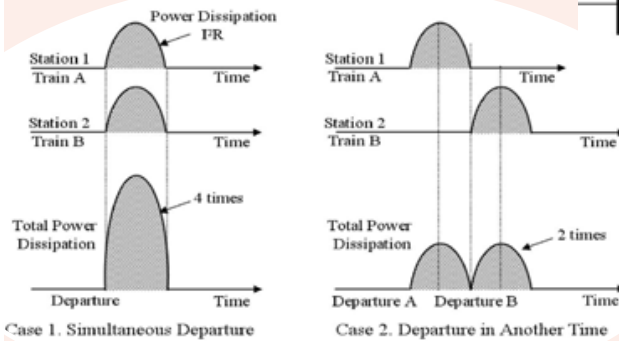

Figure 2. Power dissipation in traction phase. Source: K.M. Kim et al. (2010).

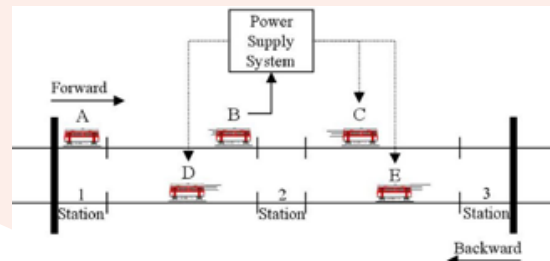

Figure 1. Group of stations. Source: K.M. Kim et al. (2010).

Therefore, if a simultaneous departure of multiple trains occurs, an increase in the power peak required is produced, which implies an increase of the ohmic losses, and consequently the energy required is bigger.

Moreover, an installation of higher power is required and therefore an increase of the investment is needed, as is shown in figure 2.

(III) Match arrivals and departures at the same station.

In a line with frequent stops and trains with regenerative brake, simultaneous departure and arrival in the same station at the same time, energy saving can be facilitated, since the energy regenerated by the train arriving (brake) may be exploited by trains leaving the stations (accelerate), as is shown in figure 3.

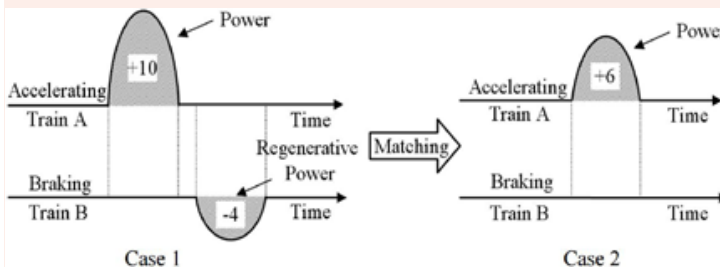

Figure 3. An example for synchronized driving. Source: K.M. Kim et al. (2010).

Objectives and benefits

Time compatibility can help reduce the energy consumption and energy costs, with a similar travel time and almost zero investment.

Table 1 shows a simulation between Madrid and Zaragoza in which, with minimal changes on the timetable in arrival and departure times at the inter-stations, it is possible to perform an Eco-driving strategy, which implies an energy reduction of approximately 33.33% (C. Sicre (2010)).

	Commercial timetable with flat-out driving				Optimised timetable with energy efficient driving			
	timetable Ri hh:mm:ss	Flat-out time Rmi hh:mm:ss	Slack time hh:mm:ss	Energy consump. flat-out kWh	Opt. timetable Ri hh:mm:ss	Designed slack time hh:mm:ss	Opt. energy consump.n kWh	Energy savings %
Madrid-Guada.	00:23:00	00:18:48	00:04:12	1,690.826	00:21:04	00:02:15	1,245.029	26,37%
Guada.-Cala.	00:39:00	00:35:15	00:02:45	2,730.136	00:41:04	00:04:49	1,835.773	32,76%
Cala.-Zrg	00:26:00	00:22:26	00:03:34	1,445.056	00:25:52	00:03:26	841.643	41,76%
Total	1:28:00	1:17:30	0:10:30	5,866.02	1:28:00	0:10:30	3,922.455	33.63%

Table1. Results of journey times and energy consumptions for commercial and optimised timetable. Source: C. Sicre et al. (2010).

Table 2 shows the energy savings in a simulation performed in line 3 in Madrid subway. It is important to notice that the total savings are approximately of 3,5%, this reduction is lower than expected, as the schedule is made with a frame time of one minute with respect to the original schedule. This new timetable allows coordinating arrivals and departures; while one train is arriving other is departing. This measure also implies that the power peak at the substation is considerably lower, with respect to the original schedule, due to the affordable use of the regenerated energy.

Substation	Energy consumption (kWh)		
	Inicial h.	Designed h.	Differences
SUB 1	767	694	10.33%
SUB 2	2,308	2,261	2.01%
SUB 3	4,000	3,917	2.60%
SUB 4	3,806	3,472	9.43%
SUB 5	4,361	4,417	-1.38%
SUB 6	2,703	2,578	4.87%
Total	17,944	17,333	3.52%

Table 2: Average of the total energy consumption at substation. Peña, M et al. (2010).

Figure 4 Shows the block diagram for optimising train energy.

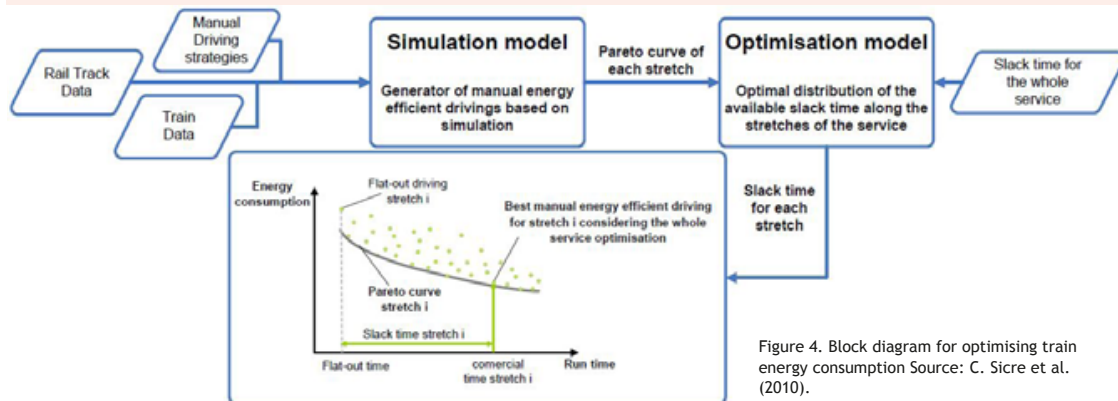

Figure 4. Block diagram for optimising train energy consumption Source: C. Sicre et al. (2010).

Applications

Theoretical applications

Author	Explanation	Benefits
K. M. Kim (2010)	This paper that proposes a mathematical approach that can increase energy saving in timetables. The energy-efficient timetabling method maintains the planned traveling time between stations, but coordinates the train departure times at the starting station from current timetable to minimize the power peak and simultaneously to maximize the re-usage of regenerative energy.	The model is verified using real data of Seoul Metro line 4. It can reduce the power peak up to 40%, and in addition, it can improve the re-usage of re-generative energy approximately 5%.

Real applications. Demonstrators

Author	Explanation	Benefits
Siemens and the Technical University Berlin	Metromiser is a driving advisory system for suburban and metro systems developed by Siemens and the Technical University of Berlin. The Metromiser consists of two components: an on-board unit (OBU) and the timetable optimiser (TTO): The timetable optimiser is an off-board based software program checking the energy efficiency of timetables. Using basic data (acceleration, rolling behaviour of the train, topology, passenger flows, etc.) it draws up a new energy-optimised timetable fitting in with the existing running schedule of the railway network.	The study claims an average of 15% of every saving achieved with the use of Metromiser.

Author	Explanation	Benefits
Peña, M. et al. (2010)	It has developed the model of economic gears for the efficient operation of the lines in rush hours, maximizing energy savings by implementing coasting orders remotor velocity and reduced brake parables, managing travel times and downtimes in station allowing to reduce the energy consumption.	This synchronized schedule was implemented in test mode for a week and the energy savings at substations were 3% less over time unsynchronized.

Bibliography

- García, A. (2016). Energía y emisiones en el transporte por ferrocarril. Fundación de los Ferrocarriles Españoles. Madrid (Spain).
- Plan de eficiencia energética del metro de Madrid (2013). Madrid (Spain).
- Kim, K. M. et al. (2010). A Model and Approaches for Synchronized Energy Saving in Timetabling.
- Fernández-Cardador, A. et al. (2008). Sincronización de arranques y paradas en metropolitanos para el uso eficiente del frenado regenerativo. II Jornadas Estrategias de Ahorro y Eficiencia Energética en el Transporte Ferroviario. 5-6 June 2008. Sitges (Spain).
- Peña, M. et al. (2010). Diseño de horarios ferroviarios para maximizar el aprovechamiento de energía procedente de sistemas de frenado regenerativo (Spain).
- UIC. Energy efficiency technology for railways. Railway energy.
- Sicre, C. et al. (2010). A method to optimise train energy consumption combining manual energy efficient driving and scheduling. Madrid (Spain).

4.3.2. Railway Smart Grids

Introduction

Efficiency

The integration of all energy management measures in an intelligent smart grid, allows improving the controllability of the system. Because of this improved controllability, electric smart grid technologies promise a significant improvement in the capacity utilization, the reliability of the system, and the energy efficiency of the grid.

Investment

No data.

Scope of the measure

- ➔ Improved design of railway distribution networks and electrical systems and their interfaces.
- ➔ Increase the stability, the suitability, the reliability, the efficiency and the manageability of the railway power system.
- ➔ Better understanding of the influence of railway operations and procedures on energy demand.
- ➔ Improved traction energy supply.
- ➔ Understanding of the cross-dependencies between technological solutions.
- ➔ Improving cost-effectiveness of the overall railway system.

Field of application

	Field 0	Field 1	Field 2	Field 3	Field 4	Field 5
Field of Application	Common measures to other sectors	Measures of train and track design	Efficient use of power traction	Optimization of operations	Use of the regenerated energy	Interaction between electricity networks
Railway Smart Grids						
		Design Measures		Redesign Measures		Operation Measures

Technology analysis I/II

A smart grid is an electricity network that can intelligently integrate the actions of all users connected to it (generators, consumers and “prosumers” who can do both) in order to efficiently deliver sustainable, economic and secure electricity supplies (EU SmartGrid Platform). In short an electric smart grid consists of the integration of information technologies into the electrical system to improve its controllability. Because of this improved controllability, electric smart grid technologies promise a significant improvement in the capacity utilization, the reliability of the system, and the energy efficiency of the grid.

In the near future, the development of electrical railway smart grid technologies is expected to allow an improved controllability of most of the elements of a railway power system (trains, substations, ESSs, etc.(see figure 1)) and, even more importantly, new types of interaction among them (see figure 2).

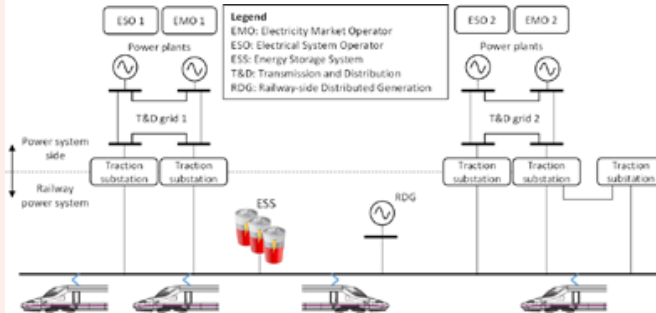

Figure 1. Physical description on interrelations among railways power systems and public grids. Source: MERLIN Project (2015). WP2. Study of the business models in scenario 3.

Conceptually, the different components of the railway power system will be grouped into control nodes capable of receiving and delivering energy to the electric network. These nodes will be monitored by a central manager programmed with the appropriate algorithms, as it is shown in figure 2.

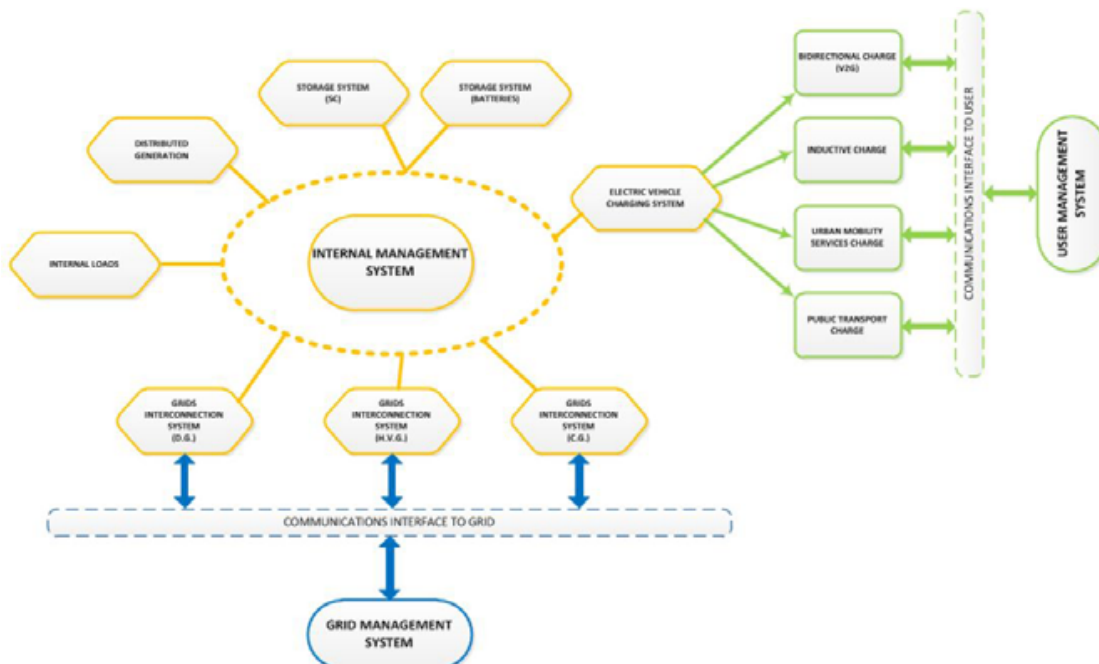

Figure 2. Full scale implementation of Smart Grids in Railway Infrastructure. Source: Win Inertia (2013).

Technology analysis I/II

Nowadays trains are merely energy consumers, but the tendency is to change towards railways smart grids, where the energy consumption profiles are optimized in real time in coordination with other trains and substations. An example of these interactions is given by the way trains are driven, as it was shown in datasheet 4.1.2. (Driving Styles), each driving style can lead to a very different spatio-temporal distribution of the power consumptions and, consequently, to significantly different requirements of the railway power system. This flexibility is the key for conceiving smart strategies for driving the trains for many different purposes, such as saving energy and augmenting the traffic capacity (see figure 3).

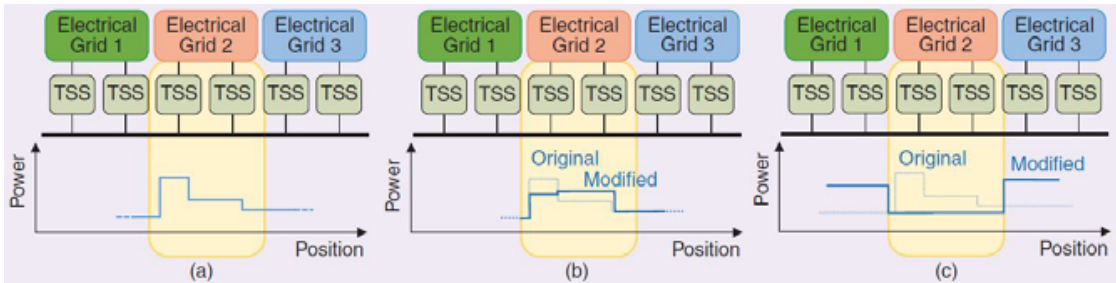

Figure 3. The different driving changes executed to manage the power demand in an RPS: (a) base case, (b) power peak reduction, and (c) energy transfer. Source: Pilo, E. et al. (2014).

The development of the railway smart grid is pushing forward a change in the paradigm in the electricity management in railway sector, which enriches interactions among the agents and gives rise to new business models. This new interactions imply that energy consumers, producers, and storages are not isolated elements, but players of the global energy game. Figure 4 shows the interactions between agents in a railway smart grid.

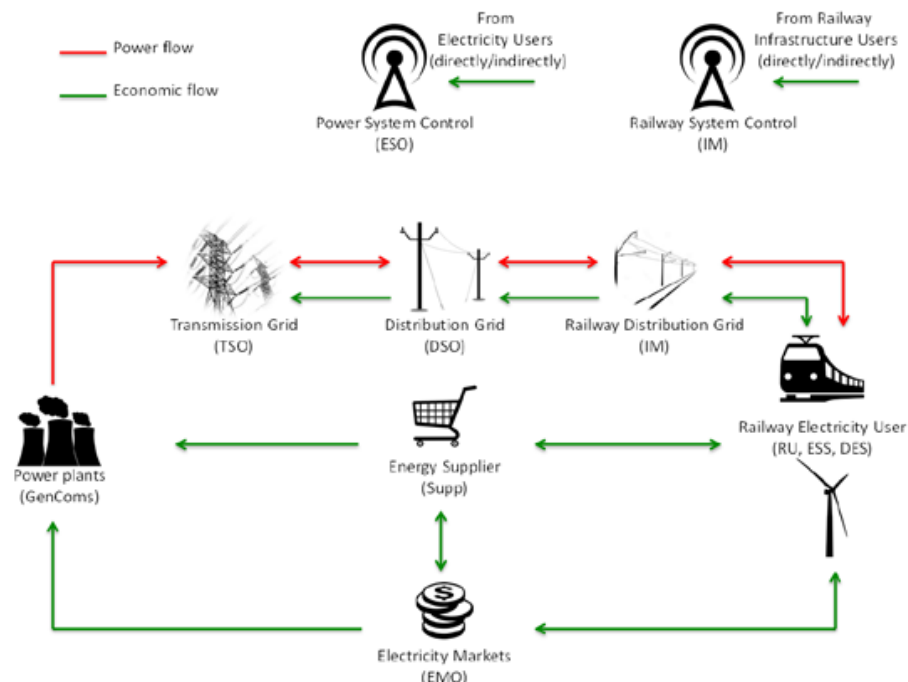

Figure 4: Agent integration and interaction in electrical and railway systems. Source: MERLIN Project (2015). WP7. Position paper for agent integration and interaction.

The adaptation of a railway power system to a railway smart grid will require the deployment of cutting edge smart grid technologies, but also a revision of the current legal framework.

Objectives and benefits

The railway smart grid's goal is to provide global energy solutions using local actions to generate and distribute energy flows in a more efficient, economical and sustainable way than a classic grid and with a supply security.

In addition to this the specific objectives can be the following:

- Improve the reliability of the rail system to be able to have certain amounts of energy in reserve and be better interconnected rail networks.
- Improving energy efficiency by optimizing the transport network energy, optimizing recoveries, and managing the efficient use of energy.
- Improving railway system contribution to the stability of the electrical system in terms of recovering the power-frequency imbalances by making use of the possibility to use for short periods of time the kinetic energy of trains.
- Integrate in traffic control systems intelligent energy management processes.
- Strengthen and automate the network, improving its operations, quality indices and losses.

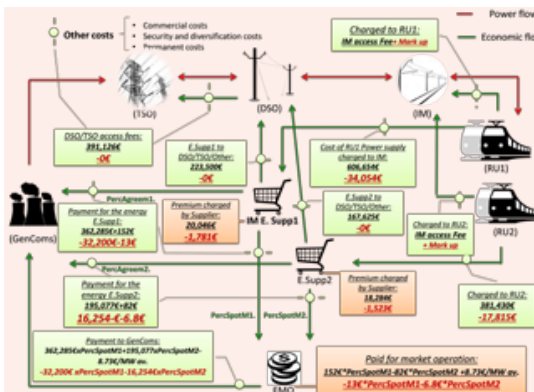

Figure 5. Economic flows in case study. Source: MERLIN Project (2015). WP7. Position paper for agent integration and interaction.

measurements take in the on-field tests conducted in the real scenario (commuter railways) overall energy consumption reductions of 11% have been considered due to the action of the REM-S, with no significant changes in the power peaks in the traction substations.

In this study case, a remuneration (in addition to the existing IM fees for the optimization of the electrical infrastructure) to the IM has been considered by means of a mark-up, which is part of the benefits (costs savings) achieved by the RUs thanks to the smart operation. This mark-up reduces the total saving obtained by the RUs (for instance deducting a percentage from the savings), but is an incentive to the continued improvement of the smart operation systems.

Based on these hypotheses, the economic flows have been calculated see Figure 4 and table 1. In figure 4, the terms PercSpotM1 and PercSpotM2 refer to the percentage of the energy managed by energy suppliers Supp1 and Supp2, respectively, purchased in the electricity market.

Overall savings of 11.48% (121,449.8€) are achieved by using REM-S, compared to a baseline scenario (which consists a single operator, no energy supplier apart from the IM and no REM-S used to optimize the operation).

Project MERLIN analyses the new business models and agent interaction for the railway systems that arise when implementing a smart grid in a specific study case. The following figure and table illustrates the main cash flows related to the novel business model analysed.

For this study case, the following assumptions have been made: (i) the smart central manager (REM-S tool) is fully implemented and is able to provide all the features included in MERLIN, allowing the operation to be optimized (energy minimization) and (ii) the two existing railway operators (referred to as RU1 and RU2) have deployed the REM-S equipment in part of their fleet (partial adoption). Also, according to the

	(€)
Total cost of the energy and power RU1	572,599.6 €
Total cost of the energy and power RU2	363,614.7 €
Cost of the energy consumed by RU1	330,085.9 €
Cost of the energy consumed by RU2	178,822.2 €
Payment form E.Supp1 to DSO/T SO/Others	223,500.9 €
Payment form E.Supp2 to DSO/T SO/Others	167,625.7 €
Premium charged by E.Supp1	18,264.4
Premium charged by E.Supp2	16,761.4 €
Payment form E.Supp1 to EMO	138.9 €
Payment form E.Supp2 to EMO	75.2 €
Total savings Case 4	121,449.8 €
Percentage of savings (ref. baseline case)	11.48%

Table 1. Economic flows analysis in this study case. Source: MERLIN Project (2015). WP7. Position paper for agent integration and interaction.

Applications I/II

Theoretical applications

Author	Explanation	Benefits
ELBAS-SINANET®	ELBAS-SINANET® is a simulator system using for the traction simulation and electrical network calculation of DC railways electrification.	The simulations realized compare two different possibilities (smart converter and flywheel) which can be integrated without many constraints on an existing network.

Real applications. Demonstrators

Author	Explanation	Benefits
Herrero, I. (2016)	The aim of the project is the development of an experimental demonstrator of the first intelligent rail power grid, which allows optimal management of the electricity system and interoperability of different systems of urban and intercity transport, electrically integrated across intelligent nodes, and interacting with the user in the vicinity of railway stations.	Making an estimation based on data consumption of electricity published in the latest Adif environmental report, if it was possible to make the most efficient power grid applied in this project in 65% of the electrified tracks, which are responsible for approximately 80% of electricity consumption, savings of up to 20% of all the electricity consumed in the rail sector can be achieved.

Author	Explanation	Benefits
East Japan Railway Co. (JR East)	They adopted smart grid technology for its railway electricity system in order to accelerate the efficient use of energy. In particular, they implement practical measures to utilize regenerative electric power, which recaptures energy when trains stop, and solar power generation. In order to do that the company introduced the technology to store the electricity at Hiraizumi Station on the Tohoku Honsen Line.	<p>The main objective is to develop an experimental demonstrator of the first Smart Railway Power Grid in order to allow the optimal management of the electric power system, the interoperability of different urban and interurban transport systems and the user's interaction in the railway stations. To improve the reliability of Railway Systems.</p> <p>To contribute with the power systems' stability.</p> <p>To introduce Smart Energy Management tasks in Traffic Control Systems</p> <p>To introduce the user as an active element of the Smart Grid</p>

Applications II/II

Real applications. Demonstrators

Author	Explanation	Benefits
MERLIN Project (2012-2015)	The MERLIN project (http://www.merlin-rail.eu) is an important initiative in the European Union (EU) context. The aim of the MERLIN project is to investigate and demonstrate the viability of an integrated management system to achieve a more sustainable and optimized energy usage in European electric mainline railway systems and to provide an integrated and optimized approach to support operational decisions, leading to a cost-effective, intelligent management of energy and resources.	<p>MERLIN goal is:</p> <ul style="list-style-type: none"> • To pave the way for many new investments on them, contributing to energy consumption and CO₂ emissions reductions. • Improved design of railway distribution networks and electrical systems and their interfaces. • Better understanding of the influence of railway operations and procedures on energy demand. • Identification of energy usage optimizing technologies. • Improved traction energy supply. • Understanding of the cross-dependencies between technological solutions. • Improving cost-effectiveness of the overall railway system. • Contribution to European standardization (TecRec).

Bibliography

- Pilo, E. et al. (2014). Railway Electrical Smart Grids. IEEE Electrification Magazine. September 2014 (49-55). Madrid, (Spain).
- Win Interia (2013). Intelligent Power Management Nodes Smart Grids Applications for Efficient Distribution Lines, Renewable Energies Integration and Efficient Railway Infrastructures in Spain. (Spain).
- Khayyam, S et al. (2016). Evolution of business model in railway industry in the presence of Energy management system. CIRED Workshop. Helsinki 14-15 June 2016. Helsinki (Finland).
- ELBAS® - The brand for special software for railway applications of the signon deutschland (Germany).
- Herrero, I. (2016). Propuesta de aplicación de una red eléctrica inteligente “Smart Grid” a la red ferroviaria española. Vialibre técnica e investigación, nº 11 63-81. July 2016. Madrid (Spain).
- EU Smart Grid Platform.
http://www.uicm.org/Documentos/UltimaHora/20150417_ENTREVISTA_ISRAEL_HERRERO-ING_TECN_INDUSTRIALES.pdf

4.3.3. Connected - DAS

Introduction

Efficiency

The efficiency of this measure comes, essentially due to the use of Drive Advisory Systems (DAS), connected to the Traffic Control Centre (TCC), allowing the best performance of Eco-driving in real time, under any operational condition and provides feedback with the aim of harmonizing individual driver behaviour.

Investment

The Benefit to Cost Ratio, considering a range of train installation costs and service, for a Connected-DAS is 2.8, which can be translated into an amortization between 1-4 years.

Scope of the measure

- ➔ Improved work environment.
- ➔ Traffic management system (TMS) integration for true fluent traffic (C-DAS).
- ➔ Reduced maintenance due to less wear and tear - especially on engines and brakes.
- ➔ Less paper at the cab. Reduced driver mistakes and increased safety.
- ➔ Improved passenger satisfaction, due to punctuality has improved from 92 to 95%.
- ➔ Results for 1500 T freight train confirm energy savings over 25% (Guys, S. 2015)
- ➔ Increased infrastructure capacity. There is an improve on the capacity in the peak hour, from 24 to 28 in the Danish Railways case.

Field of application

	Field 0	Field 1	Field 2	Field 3	Field 4	Field 5
Field of Application	Common measures to other sectors	Measures of train and track design	Efficient use of power traction	Optimization of operations	Use of the regenerated energy	Interaction between electricity networks
Connected DAS						
		Design Measures		Redesign Measures		Operation Measures

Technology analysis

As explained in the technical datasheet 4.1.3. Driving Advisory Systems (DAS) is an advanced computerized system which assists drivers in their delivery of a train service. DAS can take data from a broad range of sources in order to calculate the most appropriate speed profile for a train.

Driver Advisory Systems connected to Traffic Control Centres (TCC) are essentially DAS that have communications link with the Infrastructure Manager (IM) Control Centre in each controlled field where the train operates. This allows, in real time, the

possibility to change initial schedules, routing and speed restriction updates to trains and it also allows the information reception from drivers to the IM Control Centre to improve decisions.

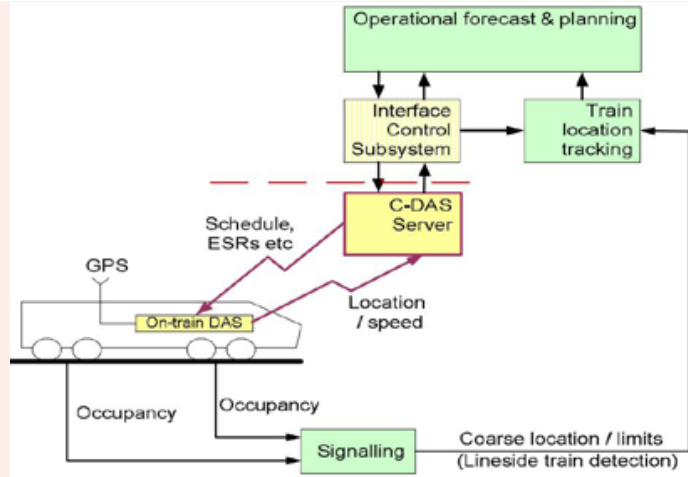

Figure 1. C-DAS scheme Source Gershuny, E (2014)

There are different Eco-Driving Systems connected to Traffic Control Centres, according to the distribution of the intelligent functions performing between Central Units (CUs) and On-board Units (OBU):

- Driver Advisory System - Central (DAS-C): In this case, computing the optimal trajectory and generating the driving advice are performed centrally. Driving advice is transmitted from CUs to OBU constantly. This requires a highly available communication channel between them.
- Driver Advisory System - Intermediate (DAS-I): CUs computes the optimal trajectory, while OBU computes the driving advice. The requirements of the communication channel are less, but the size of the transmitted message becomes bigger.
- Driver Advisory System - On-board (DAS-O): is installed on the train. It predefines a train speed profile as a standard driving guidance. DAS-O generates a series of speed advices to minimize the deviation between the predefined speed profile and the received in the train.

There are few more proposal for future railway optimization (Xialu Rao (2015)) as:

Operational scheme	Non-optimised operation	DSS for dispatcher	DAS-C	DAS-O	ATO	DAS-INT	ATO-INT
Conflict prevention:	No	Yes	Yes	No	No	Yes	Yes
Optimised train reordering	No	Yes	Yes	No	No	Yes	Yes
Optimised train speed:	No	No	Yes	Yes	Yes	Yes	Yes
On board computing power:	No	No	No	Yes	Yes	Yes	Yes
Accurate train operation:	No	No	No	No	Yes	No	Yes
Progress:	-Widely applied	-Efficient traffic management -Conflict prevention		-Improved train driving performance -On-board computing power		-Efficient traffic management -Conflict prevention -Improved train driving performance	
Remaining problem:	-Low efficiency	-No improvement in train performance -Lack of on-board		-No improvement in train performance -Lack of on-board		-No improvement in train performance -Lack of on-board	
Application domain:	-Most existing line	-Heterogeneous network design -Frequent traffic conflict happened		-Heterogeneous network design -Less traffic conflict happened		-Future railway optimisation	

Table 1. Comparison of railway capacity definitions Source Xialu Rao (2015).

• Driver Advisory System Integrated (DAS-INT), which combines the optimization efforts of DAS-C and DAS-O. The architecture of DAS-INT is similar to the DAS-I, but DAS-INT has a bidirectional communication between traffic management and train operation, which allows to have more complete information and sent it in real time.

• Automatic Train Operation Integrated (ATO-INT): This combines the optimization efforts of DAS-C and ATO. The ATO-INT scheme is similar to the DAS-INT scheme, which has a bidirectional communication between DAS-C and ATO, but ATO generates the train control command and controls train speed directly on the train.

Table 1 shows Comparison of railway operational schemes.

Objectives and benefits

The main objectives of Driver Advisory Systems connected to Traffic Control Centre is adjusting the driving strategy to save energy and at the same time increase punctuality.

Figure 2 shows the comparison between a non-optimal operation and an operation with a C-DAS and any energy reductions in a simulated case .

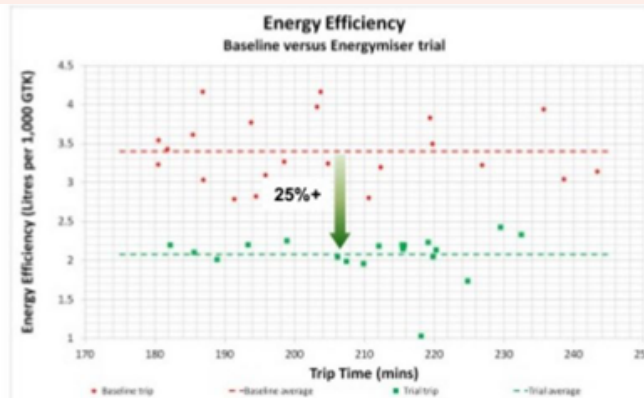

Figure 2. Results for 1500 T freight train. Source Guys, S. (2015).

Figure 3 shows the speed profile of a non-optimal operation and an operation with a C-DAS.

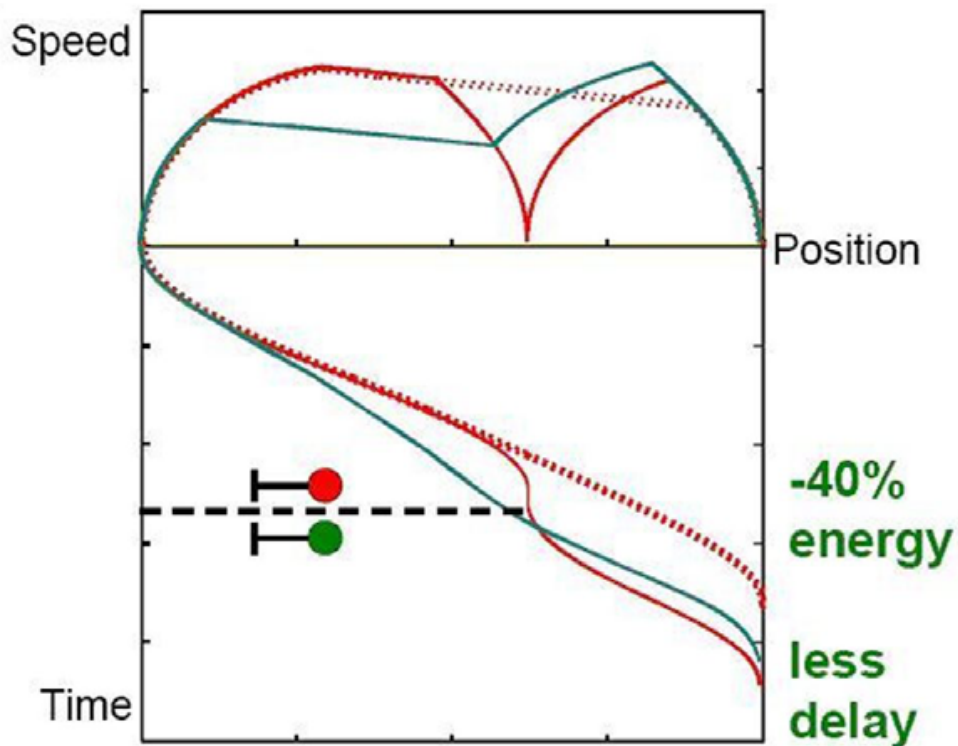

Figure 3. Speed profile of a non-optimal operation and an operation with a C-DAS. Source: Salvador, P. (2008).

Applications

Theoretical applications

Author	Explanation	Benefits
Xiaolu Rao (2015)	The thesis proposed an integrated optimisation model which can resolve the traffic conflicts by generating train running trajectories and it can achieve an accurate and optimised train operation by generating train control commands adapting to different operational scenarios.	Higher capacity in terms of reduced travel time of train and increased average speed, less energy consumption, improved operational quality in terms of increased accuracy of traffic plan execution and improved riding comfort.

Real applications. Demonstrators

Author	Explanation	Benefits
The Danish Railways (DSB)	DSB has been running with GreenSpeed DAS since March 2012 and the equipment is installed on all those units. It has two versions, one that is integrated on the train and another, a tablet version which is not integrated on the train.	Punctuality has improved from 92 to 95% and traction energy consumption is reduced by 6-8%. Also, its focus on punctuality and allows improving capacity in the peak hour from 24 to 28 trains.

Bibliography

- Technical Services: Safety, Technical & Engineering. GB Operational Concept: C-DAS. Network Rail.
- Xiaolu Rao (2015). Holistic rail network operation by integration of train automation and traffic management. Southwest Jiaotong University (China).
- Cubris UIC Energy Recovery Workshop.
- lordache, M. Optimal Strategy to Innovate and Reduce energy consumption in urban rail Systems. D4.1. Smart grid system definition, system studies and modelling, technologies evaluation.
- Ghys, S. (2015). Real time optimisation of rail operations and integration with train control systems. Presentation for Telecommunications & Train Control Conference. 18 August 2015, Sydney (Australia).
- Gershuny, E. (2014). National DAS Specification Project IRSE Seminar: DAS and ATO for Main Line Railways 28 October 2014, Network Rail (UK).
- Salvador, P. (2008). Estrategias para el ahorro de energía en la explotación ferroviaria. Universidad Politecnica de Valencia. Valencia (Spain).

4.3.4. Load factor

Introduction

Efficiency

Increasing the load factor may entail a significant reduction in energy consumption. The reductions in the specific energy consumption (kWh/seat.km) may vary between 14.48% and 17.09% depending on the type of train and service.

Investment

An increase in capacity (measured in number of seats) for the same train length, implies an additional reduction in operating unit cost and investment cost. The “utilization of interior space”, as the factor that produces a greater negative elasticity in relation to cost, implies that an increase of the 10% in the utilization of interior space would lead to a cost reduction of approximately 5%.

Scope of the measure

- ➔ The reductions in the specific energy consumption (kWh/seat.km) may vary between 14.48% and 17.09% depending on the type of train and service.
- ➔ A wide-body train with 20 - 25% more seats will be about 5-10 % cheaper for the operator.
- ➔ Comparisons made between a wide-body train and a similar conventional train shows a 10- 20% lower total cost for the same capacity.
- ➔ Short train-sets offer two main benefits in terms of operational procedures:
 - Capacity can be adapted to variable demand.
 - Trains can split up in two train-sets at a certain point of the route in order to serve two different destinations.

Field of application

	Field 0	Field 1	Field 2	Field 3	Field 4	Field 5
Field of Application	Common measures to other sectors	Measures of train and track design	Efficient use of power traction	Optimization of operations	Use of the regenerated energy	Interaction between electricity networks
Load factor						
		Design Measures		Redesign Measures		Operation Measures

Technology analysis

The energy efficiency performance of any transport mode is strongly sensitive to the load factor, which is defined, for passenger service, as passenger-km/seat-km.

Due to the unfavourable ratio of dead weight over total weight, the energy demand of a passenger train is virtually independent of the load factor. The energy invested in moving a train is more or less the same whether the train is empty or full; a higher load factor will usually imply a lower consumption per passenger kilometre (in the case of passenger service) or ton kilometre (in the case of freight service). This is the reason why raising occupancy probably offers the biggest potential to save energy per passenger-km.

The average load factor in railway operation cannot only be raised by marketing strategies but also by technological options, such as more flexible vehicle concepts allowing an adaptation of train length to demand variations.

These are some of the technological ways to increase the load factor:

- Adapting train length to passenger numbers in a more flexible manner. In passenger service, short modular MU train-sets prove to be the most promising concept. The idea of modular train-sets pretend to achieve the advantages that loco-hauled trains and multiple units offer. On one hand, loco-hauled trains have the advantage that they can be shortened or lengthened. On the other hand, multiple units have the advantage that, since the traction equipment is placed along the train, the load factor is higher.

Short train-sets offer two main benefits which are both relevant for energy efficiency:

- Capacity can be adapted to variable demand. That is useful for local services, whose demand along the day suffers strong variations (peak hours vs. late evening).
- Trains can split up in two train-sets at a certain point of the route in order to serve two different destinations.

- There are also two other architectural options which allow increasing the load factor, such as using a wide body or double-deck trains (and even the combination of both), which offer additional and compatible reductions in energy consumption. The reason for their greater efficiency lies in the considerable increase in the number of seats with only a slight increase in the train's mass and volume.

- Wide-body. The standard width is considered to be the exterior width of the body (2,950 mm), which is that of the long bogie cars (26 m), compatible with gauge C including on UIC leaflet 505. This exterior width permits an interior width of between 2,650 and 2,800 mm, which makes it possible to install four columns of seats of normal dimensions (450 mm per seat, 50 mm per armrest and a 450 mm aisle; in total, 2,550 mm). Wide bodies would be those which allow more seats to be installed in each row, e.g. at least 5 seats per row in second class for long distance and regional services, and 6 seats for commuter services. For this purpose, the minimum interior width required would be 3,100 and 2,970 mm respectively, leading to minimum exterior widths (with current construction technologies) of 3,200 mm and 3,070 mm.

- Double-decker trains. Its capacity is also greater than single deck trains, however in practice it does not reach the double. It can be asserted that a double-decker train has approximately 65% of length of a single-deck train.

- Trains may be also wide-body and double-decker, since these characteristics are independent and not incompatible. The most famous example is the Japanese high speed train MaxE4 operated by JREst, which in 400 m of length achieves to place more than 1,600 seats.

Train	Country	Exterior width (m)
S commuter trains	Denmark	3.600
IC/3 train	Denmark	3.100
Sleeping cars	Norway	3.240
SM90	Holland	3.200
Shinkansen	Japan	3.380 - 3.400
Francilien	France	3.100
Sm3	Finland	3.200
Talgo AV 3G and Avril	Spain	3.200
Velaro RZD	Russia	3.265
CNH3 (Velaro)	China	3.265
High speed trains	China & Taiwan	3.380

Table 1. Some wide-body trains in different countries of the world (>3.10 metres). Source: Andersson et al (2000), Naoto (2010), completed and adapted.

Objectives and benefits

Load factor parameter intervenes directly in the train's characteristics and architecture (capacity), and therefore its increase entails (as we have already mentioned) a significant reduction in energy consumption.

An increase in capacity (measured in number of seats) for the same train length, implies an additional reduction in specific energy consumption and unit operating cost. Specifically, the reason why a wide-body train has a lower energy consumption per seat.km in comparison with a standard-width train of equivalent capacity is that it has a lower mass per seat and a smaller wetted surface area per seat (which affects the aerodynamic resistance).

Essentially, there is a reduction in specific energy consumption and operating unit costs due to the negative elasticity of costs and energy consumptions in relation to the train's capacity (the greater the capacity, the lower the costs, consumptions and emissions). Andersson et al. (2001) have identified the "utilization of interior space" as the factor that produces a greater negative elasticity in relation to cost: -0.5 (a 10% increase in the utilization of interior space would lead to a 5% reduction in costs).

The effect of an increase of the load factor and its negative elasticity with the specific energy consumption has also been studied in German railways; for instance, the 2005-2012 increase of 24% in calculated load factor (pkm/train-km) corresponds to a decrease in passenger specific energy consumption of 22%.

A similar consideration can be made for Austria railways, which is one of the major contributors of the reduction of European specific energy consumption in freight: For a 39% increase in calculated (net tkm/train-km) load factor between 2005 and 2012, there is a 27% decrease in specific energy consumption.

The energy consumption per unit of capacity is also estimated in García Álvarez, A. and Lukaszewicz, P. (2010) and the results obtained are shown in table 2.

It can be underlined that the reductions may vary between 14.48% and 17.09% depending on the type of train and service.

Type of train / service	KWh /km.train		Wh /plest		Diff. (kWh/ km.train)	Diff. Wh / plest (%)
	Normal Body	Long wide body	Normal Body	Wide body		
High speed distributed traction (420/461 m2)/HS LD	15.99	16.67	37.80	31.81	+0.68	-15.84%
High speed concentrated traction (420/461 m2)/HS LD	19.93	20.81	53.43	45.04	+0.88	-15.70%
Conven. with locom. (481/542m2) / Conventional	14.30	14.99	32.64	27.60	+0.69	-15.44%

Table 2. Effect of the wide body on energy consumption per unit of capacity comparing trains of the same length. Source: García A. et al. (2010).

Regarding costs, Andersson et al. (2001) estimate that the absolute purchase cost of a wide-body train is, on average, 7% higher than that of a normal-body train of the same length, which would result in a 14.4% lower unit cost. Lukaszewicz (2009) points out that the comparisons made in Sweden between a wide-body train and a similar conventional train indicate a 10- 20% lower total cost for the same capacity.

Applications

Theoretical applications

Author	Explanation	Benefits
Andersson et al. (2001)	A fundamental technical and economic analysis on efficient and attractive passenger train operations has been conducted in a university-based research environment (Railway Group of KTH), in co-operation with Swedish industry, rail administrations and rail operators.	The first extra wide-body trains in Sweden are 3.45 m wide in comparison to the ordinary Swedish width of about 3.10 m. This provides good possibilities to furniture the cars with 2+3 comfortable seats in second class and 2+2 seats in first class. The increased space utilisation makes it possible to shorten the average length of future passenger trains by about 20 %. Thereby the operators' cost per passenger kilometre can be reduced by 5 - 10 %.

Author	Explanation	Benefits
García Álvarez, A. and Lukaszewicz, P. (2010)	The study analyses the effect of the variation of size or architecture of trains on the energy consumption and costs. The analysis is carried out for trains of different architectures and sizes and on different lines, since the wide body is compatible with all architectures, sizes and types of services. The aim is to verify whether the improvements provided by the wide body extend to all type of trains.	The results obtained can be summed up in the following conclusions: 1. A wide-body train with a 3+2 seating layout permits, for the same capacity, a reduction in train operating costs of between 5.22% and 9.8%; and between 14.00% and 15.73% when compared with a normal-body train of the same length. 2. For the same train length, the wide body (with a 3+2 layout) permits a 20-23% increase in the number of seats with a cost reduction per seat of between 14 and 16%. 3. The wide body permits significant reductions in specific energy consumption, which vary between 5.30% and 10.53% when compared with normal-body trains of the same capacity, and between 14.48% and 17.09% when compared with trains of the same length (and therefore, of greater capacity).

Real applications. Demonstrators

Author	Explanation	Benefits
Short train-sets. IC3/TRD type	IC3/TRD type: special cases are the Danish IC3 and the Spanish TRD concept. The train-sets are short (3 and 2 cars, respectively).	Can easily be coupled for achieving longer compositions.

Author	Explanation	Benefits
ICE-T	The DB AG (Germany) ordered the ICE T tilting trains in two lengths, 5 cars and 7 cars.	Capacity can be adapted to variable demand due to its flexibility.

Author	Explanation	Benefits
ICE 2	The typical configuration for the German ICE 2 is a double set of cars, having each one a locomotive at one end and a small driving cabin at the other end.	To a certain extent this vehicle concept allows an adaptation of train capacity to actual demand. ICE 2 can be split at some point of the journey, as it has a common branch and two different endings, as it happens in the Berlin-Cologne line.

Bibliography

- Andersson, E. et al. (2001). Extra wide body passenger trains. World Congress on Railway Research (WCRR 1), Cologne (Germany).
- Kottenhoff, K. et al. (2009). Attractive and Efficient Train interiors. Ed.: KTH Railway Group, Publication N.0903. Stockholm (Sweden).
- Lukaszewicz, P. (2009). Possibilities for high speed trains with 2+3 seating arrangement. Transrail, (Sweden).
- Naoto (2010). "World High Speed Rolling Stock". UIC, Paris (France).
- IZT, UIC Deutsche Bahn AG and Railway Environment Centre (2003). Evaluation of Energy Efficiency Technologies for Rolling Stock and Train Operation of Railways, March 2003, Berlin (Germany).
- UIC. Energy and Emissions reduction drivers for European railways.
- García, A. et al. (2010). Energy and cost advantages of wide-body trains. CTF-2010. Zaragoza (Spain).

4.3.5. Metering devices

Introduction

Efficiency

The first step to analyse and improve the energy efficiency of any system is to gather reliable data. The biggest share of the total energy consumed by a railway system is used for traction, but auxiliary systems and other non-traction loads have also a significant impact in the energy expenditure. By installing metering devices that monitor all railway systems, a better, deeper assessment of their performance can be done, thus paving the way for a reduction of their energy consumption.

Investment

The cost of sensors and complementary equipment (i.e. data storage unit) is relatively low. Installation in existing vehicles and facilities (substations) is also reasonably simple, depending on the complexity of the monitoring system.

Scope of the measure

- ➔ Gathering reliable data on the energy consumption of non-traction loads is an essential first step in the evaluation and reduction of energy consumption.
- ➔ Measuring the energy consumed by non-traction loads may help to improve the efficiency of auxiliary systems, thus reducing CO₂ emissions at local level (diesel trains).
- ➔ Data allowed the rail manager to make some adjustments that yielded an energy saving of 10.2%, the equivalent of 85 tons of CO₂ per year (Leindecker, 2014).

Field of application

	Field 0	Field 1	Field 2	Field 3	Field 4	Field 5
Field of Application	Common measures to other sectors	Measures of train and track design	Efficient use of power traction	Optimization of operations	Use of the regenerated energy	Interaction between electricity networks
Metering devices						
		Design Measures		Redesign Measures		Operation Measures

Technology analysis

Despite their inherent efficiency compared to other transport means, railways are heavy energy consumers. Energy supplied to rolling stock is consumed mainly for traction, but other auxiliary systems such as HVAC, lightning or loudspeakers also require a significant amount of energy. All these auxiliary systems (also known as ‘hotel loads’) consume a share of the total energy supplied to the train that may range from 10-15% to almost 50% depending on several factors. The most energy consuming auxiliary system is the HVAC, which usually accounts for about 80% of the hotel loads (Martínez et al. 2015). and the consumption of auxiliary systems has been often neglected despite their significant impact on the overall energy of a railway vehicle.

Traditionally, railway companies do not monitor the energy consumed by each of their trains. Instead, energy is measured (and billed) only at the substation level, and thus only global energy expenditure is known, which include the energy consumed by rolling stock, track systems, stations, etc. The real time energy consumption of each subsystem of a train is often unknown (García and Martín, 2008).

Over the last few years, due to increasing concerns regarding energy efficiency and environmental impact, many railway stakeholders have started to install metering devices in their trains so as to monitor their energy consumption. The main objective of these initiatives is to gather reliable data as a first step to assess and improve the efficiency of rolling stock. Up to now the main focus of such research has been on traction energy, and the consumption of auxiliary systems has been often neglected despite their significant impact on the overall energy of a railway vehicle.

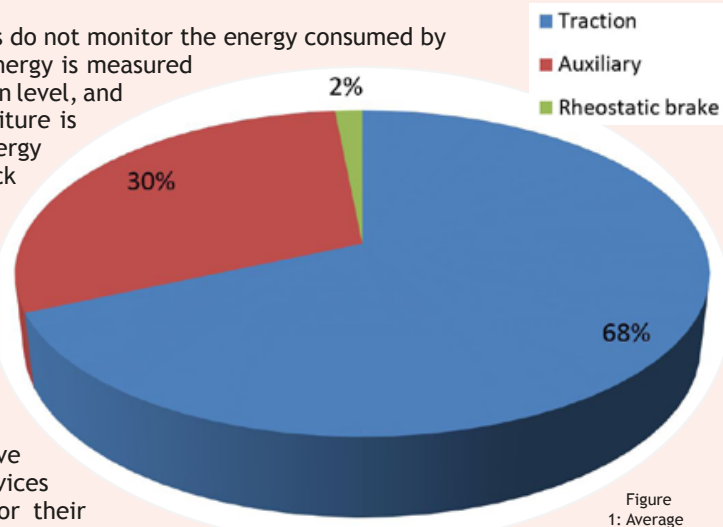

Figure 1: Average energy consumption distribution in a metro network. Source: Martínez et al. (2015).

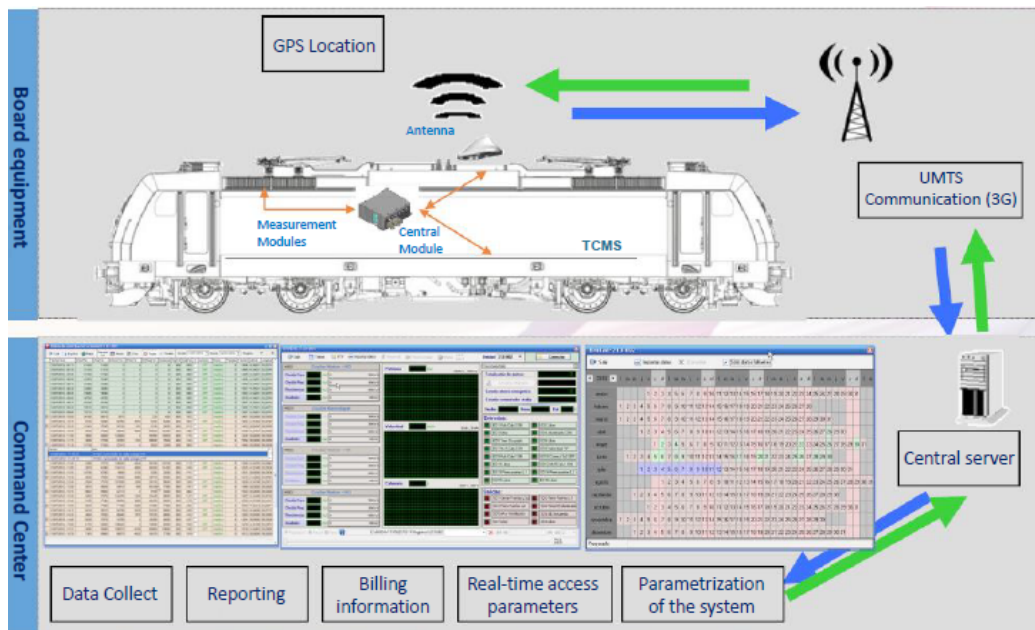

Figure 2: Scheme of the behaviour of the Bombardier metering device system. Source Vila, E. (2015).

Objetives and benefits

In order to reduce the amount of energy consumed by a railway system, first it is necessary to measure the energy consumption of all elements during normal operation. This includes traction, hotel loads and other auxiliary systems. Only when accurate, reliable data is available, a thorough assessment of their performance can be carried out and the measures to improve their efficiency can be developed. Nowadays there are many sensors available in the market to

measure energy consumption, in diesel trains (fuel flow meters) and electric trains (sensors that measure voltage, current and power).

Although real-time energy monitoring has been focused mainly on traction over the last few years, the benefits of measuring also the energy consumption of auxiliary systems have been verified in different railway systems. In electric trains, this allows defining the fraction of the total energy supplied that goes to such systems, and which is actually used for traction.

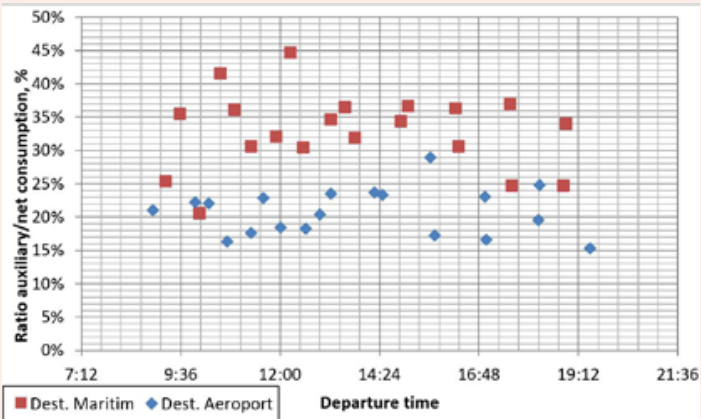

Figure 2: Ratio between auxiliary and net energy consumption in two lines of the Valencia Metro Network. Source: Martinez et al. (2015).

During a research project carried out in the Valencia Metro Network, it was found that the average net energy consumption per service in Line 5 was between 75 and 105 kWh depending on the direction. Additionally, the ratio between auxiliary and total energy was found to be between 15% and 45%, and thus it is a factor to be taken into account when devising new measures to reduce energy consumption and increase efficiency. Finally, it was found that only 1% of the net energy consumed is dissipated in the rheostatic brake.

Another process of measurement and analysis of railway energy consumption was carried out by JR East for their Shinkansen (High Speed) trains in Japan. Monitoring devices were installed in one Series E5 Shinkansen train. Data obtained allowed the railway company to evaluate the correlation between energy consumed by the HVAC system, outdoor temperature and passenger load factor, thus paving the way for a better management of heating and cooling processes.

During a pilot project carried out in the Tram system of Linz (Austria), a tram vehicle was equipped with metering devices that provided useful information regarding the performance of the heating system. This data allowed the rail manager to make some adjustments that yielded an energy saving of 10.2%, the equivalent of 85 tons of CO₂ per year (Leindecker, 2014).

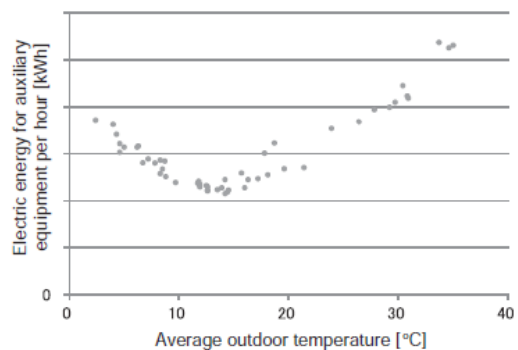

Figure 3: Outdoor temperature and electric energy of auxiliary equipment per hour. Source: Mizuguchi, Y. et al. (2015).

Energy can also be monitored at the substations that feed the catenary. This is a more widespread trend as electrical companies measure and bill the energy supplied to railway companies at the substations. However, it is also possible to install more accurate monitoring devices so as to get a deeper understanding of the energy consumed and its distribution. As part of the Merseyrail Energy Monitoring Project (Stewart et al., 2011), substations were equipped with current and voltage sensors to compare their energy output with the energy input to trains, hence accounting for transmission losses as well as providing data for efficiency assessment of the whole system.

Applications

Theoretical applications

Author	Explanation	Benefits
UIC UNIFE	The UIC, together with the Association of the European Rail Industry (UNIFE) have elaborated a document with technical recommendations for the measurement of energy consumption of rolling stock.	The recommendation became a Technical Specification (CENELEC CLC/TS 50591) in 2013, and it is expected to become a European Norm in 2016.

Real applications. Demonstrator

Author	Explanation	Benefits
Ferrocarrils de la Generalitat Valenciana (FGV) Universitat Politècnica de València Spanish Ministry of Economy and Competitiveness	Within the context of a research project that aimed at assessing the energy consumption of railways, a metro train operating in the Valencia metro network was equipped with monitoring devices. These devices measured the energy supplied to the train, the energy consumed by auxiliary systems and the energy consumed in the rheostatic brake.	Data monitoring was carried out between July and October 2014. Up to 229 train services were monitored, accounting for more than 230 hours of data. Once processed and analysed, main consumption trends were identified and some measures to increase efficiency were proposed.

Author	Explanation	Benefits
The University of Birmingham Merseyrail Network Rail UK Department for Transport	A project to measure simultaneously the power output from substations and the power input to vehicles was carried out in the Merseyrail Network. The objective was to evaluate energy losses and assess the effect of different driving styles on the overall energy consumption.	The project results indicated that the monitoring is practical and the data obtained is sufficient to understand the system losses. Moreover, the data obtained allowed analysing the effect of different driving styles and identifying low efficiency areas.

Bibliography

- Martínez, P. et al. (2015). Measuring and modelling energy consumption in metro trains by means of neural networks. 13th Railway Engineering Conference. June 30 - July 1, 2015. Edinburgh (Scotland).
- García, A. et al. (2008). Cuantificación del consumo de energía eléctrica del ferrocarril español (Quantification of the electric consumption of Spanish Railways). Fundación de los Ferrocarriles Españoles, Madrid (Spain).
- Leindecker, W. (2014). Real-time monitoring lifts the lid on LRV energy use. International Railway Journal. Available at: <http://www.railjournal.com/index.php/rolling-stock/real-time-monitoring-lifts-the-lid-on-lrv-energy-use.html> (accessed 29/07/2016).
- Mizuguchi, Y. et al. (2015). Measurement and Analysis of the Driving Energy of Shinkansen Rolling Stock. JR East Technical Review, 31.
- UIC (2015). Railway Handbook 2015. Energy Consumption and CO₂ emissions. Available at: <http://uic.org/energy-and-co2-emissions> (accessed 27/07/2016).
- Stewart, E. et al. (2011). The Merseyrail Energy Monitoring Project. 9th World Congress on Railway Research. May 22 - 26, 2011. Lille, (France).
- Vila, E. (2015). Herramientas para la Gestión Energética de flotas. Jornada Técnica de la PTFE: gestión energética sostenible e inteligente en el ámbito ferroviario 12 de marzo de 2015, Madrid (Spain). Ref. PTR-2014-0351.

Source: Eva Suárez.



5. Conclusions

5.1. Measures

Measures that allow energy reductions

It is arguable that there are many different measures and technologies that have a large impact on reducing energy consumption and therefore CO₂ emissions. Many of them apply not only to the rail sector, but to everyday life issues, such as disconnection of loads in times when there is no use of equipment (e.g., turning off lights). Regarding this situation, this study has decided to take an approach that to emphasize those measures that are unique to the rail or have a large impact on energy consumption in the railway sector.

For the purpose of this document measures are grouped into these 4 main areas:

1. Measures related to the design of the infrastructure, installations and rolling stock:

- The design of an efficient infrastructure may reduce the use of the brake which means a reduction of losses. For example the existence of an upward gradient at the entrance of a station may imply savings of **5% in tractive energy consumption** and **23% in braking energy** García Alvarez, A (2009).
- Design of trains considering new train architectures that allow reducing drag resistance. An aerodynamic drag reduction of 25% may lead a **15% of less traction energy usage**.
- Introduction of new materials that allow decreasing, for example, the total weight of the rolling stock, which will help to reduce the energy consumption. Composite materials meet stringent requirements even at aggressive operating conditions and, at the same time, may reduce a **5% of energy consumption** and CO₂ emissions.
- Use of the renewable sources in non-traction loads, as workshops, stations, may have a significant impact in the CO₂ emissions. For instance, there are a 2.2 mile long tunnel that cross Antwerp in Belgium which is fitted with 16,000 panels between that are installed over on the roof. These installation could generate 3.3 MWh of electricity annually and help to save about **2,400 tons of CO₂ per year**. They provide enough electricity to power 4,000 trains a year and for lighting, signals and other infrastructure.

2. Measures related to power traction. Among them, the following can be highlighted:

- Electrify those railway lines that are not electrified can bring to electric traction gross tons that currently are transported by diesel traction. According to Network Rail (2009)¹, there is a decrease between **19% and 33%** in CO₂ emissions.
- Reduction of losses in the traction chain due to the deployment of new technologies. The use of more advanced technologies (i.e. AC asynchronous traction motor with IGBT inverters) may lead an increase of the efficiency and a reduction of **15% of the energy consumption**.
- Inclusion of reversible substations in the power supply system, mainly in DC electrification lines, contributing to a higher use of the energy returned to the grid by trains (this new technology is able to capture at least 99% of braking power), which can lead to **energy consumption savings between 7% and 15%** depending on the line and the services.
- Adding to the operator fleet new rolling stock which uses alternative fuels (as liquid gas or hydrogen fuel cells).

¹Network Rail (2009). "Network RUS electrification (UK)".

3. Measures related to ancillary systems. They should take into account the incorporation of new technologies that allow decreasing the energy consumption in both the ancillary systems on-board (as HVAC technologies or new lighting systems) and the ancillary system of the infrastructure.

- Some estimations and models, calculate energy savings between 15% and 30%, regarding new technologies of ancillary systems implemented on board (i.e. HVAC).
- Moreover, new and more efficient point heaters, with improved insulations and regulation have yield an **average energy saving of 30%** (Eltherm GmbH, 2016) compared to conventional point heaters.





4. Measures related to Smart Energy Management. Amongst them the following can be underlined:

- Measures related to operational procedures, for example load factor. Increasing the load factor may entail a significant reduction in energy consumption. According to García Álvarez, A. and Lukaszewicz, P. (2010), the reductions in the specific energy consumption (kWh/seat.km) may vary between **14.48% and 17.09%** depending on the type of train and service.
- Measures related to driving styles, by either the introduction of ECO-Driving Systems or due to the driver's knowledge of the existing differences of the driving techniques, Depending on if the trains has regenerative brake or not. The benefits from implementation of a DAS include reductions in energy consumption by avoiding unnecessary braking and running at reduced speeds. These energy consumption **reductions can reach up to 20%**.
- Introducing, in the power network, Energy Storage Systems and provide them with "intelligence" in order to manage the use of the energy. The introduction of new developments of Energy Storage Systems, as Fly-wheel, Supercapacitors or Batteries, may reduce the energy consumption **between 10% and 30%** depending on the system, the line and the type of service and a **substantial reduction in power peaks (50%)**.
- Introducing Smart Grid technologies that allow a greater controllability of the electric loads (trains, auxiliaries...), in order to, for example, reduce power peaks in a specific area of the line. Project MERLIN² analyses new business models and agent interaction for the railway systems that arise when implementing a smart grid in a specific study case, the results obtained, in these specific cases analysed, show a **potential energy reductions of 11%**.

As the data shows (the potential savings of energy consumption), the possibilities of increasing the efficiency in the railway sector are huge and diverse; however the challengers are even greater.

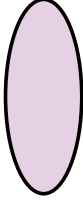
²The MERLIN project (<http://www.merlin-rail.eu>) is an important initiative in the European Union (EU) context. The aim of the MERLIN project is to investigate and demonstrate the viability of an integrated management system to achieve a more sustainable and optimized energy usage in European electric mainline railway systems and provide an optimized approach to support operational decisions, leading to a cost-effective, intelligent management of energy and resources.

ing shape, shows a comparison between the different technologies according to their relationship with the efficiency (related to the section, subsystem in which each measure is applied) and investment (difference between the investment which is necessary to undertake with and without the implementation of the measure) for the four studied sections.

Mea infr inst	
Mea pow	
Mea anci	
Mea ene	

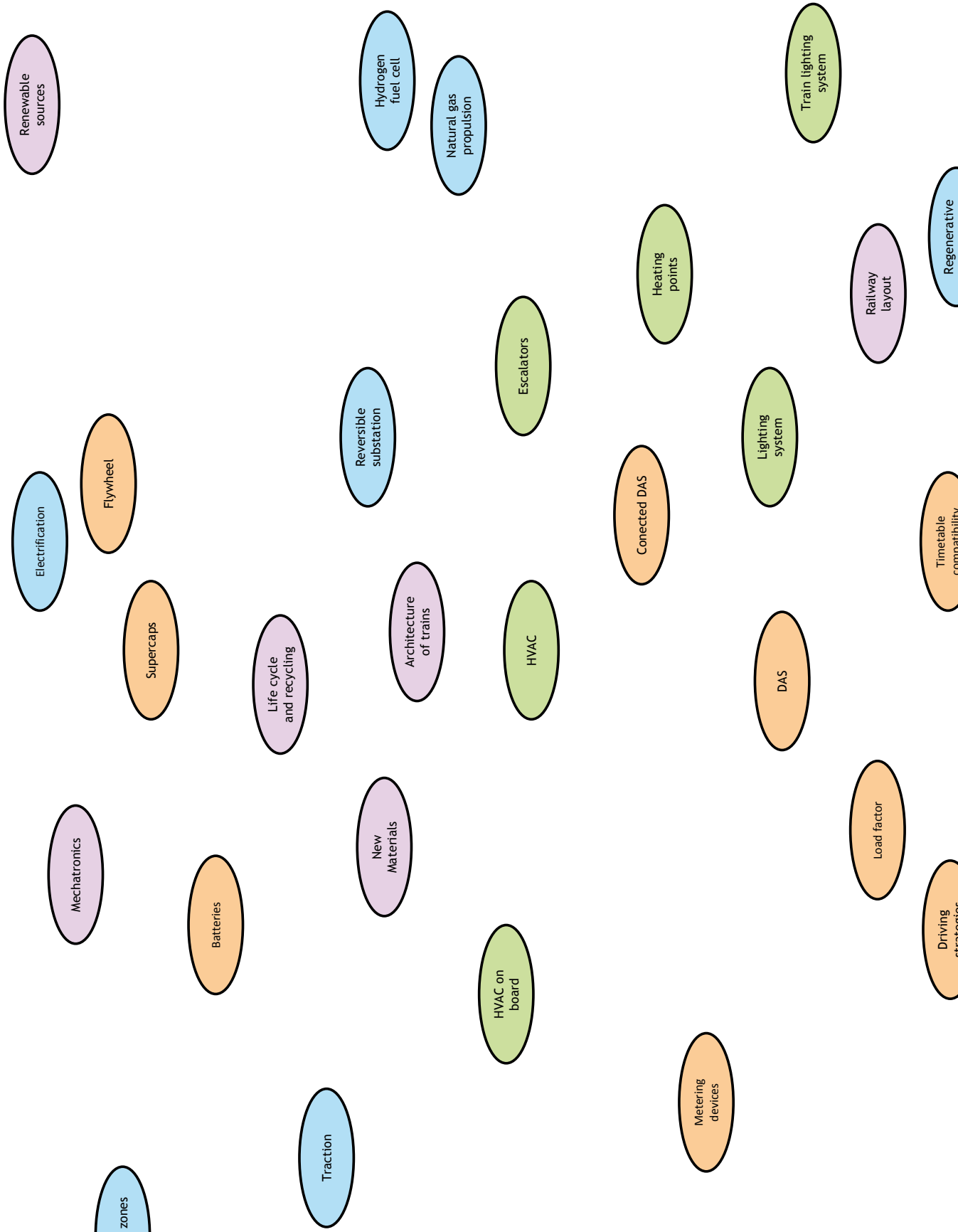

5.2. Reflections on the future

The significance of the energy efficiency in the railway sector

It is socially accepted that railway is more energy efficiency and environmentally friendly than other competing transport modes, in both, regarding primary energy consumption (especially that primary energy that comes from non-renewable sources) as well as in GHG emissions. Besides, the gas emissions at local level are lower, both in quantity as well as in the relocation of the greenhouse emissions. Actually, this belief corresponds to reality in most cases.

More recently, it is demonstrated that high speed rail is not only more energy efficiency and environmentally friendly than other competing transport modes, but also it is more energy efficiency and environmentally friendly than the conventional train which replaces. Furthermore, the higher the speed, the higher the capacity of passenger attractiveness from other transport modes which are less energy efficiency and environmentally friendly (especially plane and car), thus, the increasing of train speed also contributes to the increase of the efficiency of the transport system.

Despite the difficulties of homogeneous and fair comparatives, figures show that railway, especially with electric traction, obtains important advantages for society when passengers and goods from other modes are attracted, particularly by reducing GHG emissions. Neither this reality extends to all cases nor is the railway intrinsically superior. This means that, it is not true, as it is asserted usually, that the main reason for the lower energy consumption and emissions compare to car mode, are due to the lower friction between wheel and rail compared to the friction between rubber and road. Even though effectively, this friction is lower, the weight per seat of trains is disproportionately higher than other transport modes, and this makes it almost irrelevant the difference regarding friction resistance.

A more detailed and in-depth overview of the subject leads to the conclusion that the energy and environmental advantages of rail actually stem from four fundamental aspects:

1. **High capacity**, provided that the utilization rates are reasonable, reducing fuel consumption and emissions per unit of capacity and traffic.
2. **Electrification**, which allows the use of renewable energy sources, which reduces and relocates emissions.
3. **Permanent connection to the grid**, which allows better use of energy regenerated during braking, the power sent to the grid, and even supporting the efficiency of the system as a whole.
4. **Speed**, which allows the railroad to capture traffic from other less energy efficiency and environmentally friendly transport modes.

The truth is that the leading position of the train has not been a stimulus to improve energy efficiency, in general, this has remained substantially stable over the last 20 years. Some technological improvements have been offset by the increased consumption of auxiliary in passenger services. Meanwhile, in other modes of transport, where the cost of energy is a very important part of the total costs significant efforts, have been made to improve efficiency, so that the advantage of the train has been reduced in recent years.

The possibility to continue losing its advantages (which are those that justify the investments in rail) is more evident as the demands of reducing GHG emissions agreed in the recent UN Paris summit will force that, in a not a very long term, virtually all cars will be electric, and power generation will be free of emissions of greenhouse gases. Then the railroad will have lost a part of its competitive advantages.

It is normal to ask if in this context rail will remain superior from an energy efficiency and environmental point of view. And the answer is yes, but as long as it is able to maintain and deepen the other levers that make this superiority possible.

Specifically, railway should use its ability to operate large trains, both passengers and freight, which offer much lower unit consumption and that further reduce unit operating costs, and can offer cheaper services and thus attract traffic from other modes. Railway can further exploit this “virtuous” spiral: price drop, which leads to more traffic, which allows larger trains, which then reduces costs.

In addition to the need of the existence of demand (the current low share of rail guarantees the existence of demand now channelled by other modes of transport) further technical measures are necessary to make larger trains possible, which will also allow better use of infrastructure investments: improved gauges, higher axle weight admitted, longer trains, more effective ability to couple and uncouple train branches will allow more capacity and therefore will be more efficient and competitive.

Moreover, rail passengers especially in medium and long distances, will only be relevant if it is able to improve its speed. Therefore, high speed and improving speeds in conventional lines will lead to the attraction of passengers from other modes, reducing the overall energy demand.

Finally, and this is the most specifically energy lever, railways must maximize their advantages of being permanently connected to the electricity grid and interacting with it. Electric cars and trucks in principle cannot interact with the grid within a reasonable time (there is some experience in Germany of an electrified motorway with the circulation of “trolleytruck”). Onboard energy storage systems will remain the basis of operation of trucks and electric cars, and certainly aircraft and ships. Trains, however, can exploit these advantages of permanent connection that certainly will exempt them from losses due to recharge time and the inconvenience of moving heavy energy storage systems. But above all, rail can dynamically and intelligently interact with Smart Grids, returning power to the grid when it is most needed or storing it in substations in the network when there is a surplus; and even offering (with adequate remuneration) to the interruptibility in the case of an imbalance in the power-frequency of the system, which also can be supported with the energy generation of trains that can be “invited” to stop (generating energy) for a few minutes to support the system. Coordinating train schedules to synchronize starts with braking is another optimization possibilities offered by the permanent connection to the electric grid.

To sum up, as we have shown, railways have an enormous potential. By 2030 they could reduce the system emissions as a whole between 20% and 30%, but must not lose sight of what their true strengths are in order to deepen and preserve them to obtain the best outcome.

5.3. Bibliography

- Eltherm GmbH (2016). Railway Heating Systems. Innovations in heat tracing (brochure). Available at: <http://eltherm.com/355/rail-and-point-heating> (accessed 19/07/2016).
- Faranda, R. (2007). Energetic sustainable development of railway stations. Power Engineering Society General Meeting. Tampa, USA, June 24-28, 2007.
- García, A. (2009). Energía y trazado ferroviario. Curso de diseño de ferrocarriles. CEDEX. November 2009. Madrid (Spain).
- García Álvarez, A. and Lukaszewicz, P. (2010). “Energy and cost advantages of wide-body trains”. CTF-2010. Zaragoza.
- Khayyam, S et al. (2016). Evolution of business model in railway industry in the presence of Energy management system. CIRED Workshop. Helsinki 14-15 June 2016.
- MERLIN Project, (2015). WP2. Study_of_the_business_models_in_scenario_4. (2012-2015).
- Network Rail (2009). “Network RUS electrification (UK)”.
- Wired UK (2011). ‘Solar Tunnel’ To Power 4,000 Trains Annually. 06.08.11.

Source: UIC



16, rue Jean Rey
F-75015 Paris FRANCE
www.uic.org



Technical support

Calle Santa Isabel, 44.
28012 Madrid SPAIN
www.ffe.es