

# *Solar Thermal Power / Heat Storage*

John C. Bean

## Outline

Appearance to the contrary, Solar Thermal IS just another way of boiling power plant water

Variations on Solar Thermal's essential light concentrator: Parabolic Mirrors

Concentrators' need for direct / unscattered sunlight => Mandatory use of desert locations

Novel / Non-Commercial Solar Thermal Schemes:

Updraft & Downdraft Wind Chimneys

Dish-Stirling Engine Plants

Mainstream / Commercial (albeit subsidized) Solar Thermal Plants:

Solar Towers / Power Towers / Central Receivers (three names for the same thing)

Parabolic Troughs

Linear Fresnel Reflectors

Including discussion of Receivers & Heat Transfer Fluids for all of the above

How heat storage might make Solar Thermal the first truly 24/7 green energy source

Ending its distinctly non-green marriage-of-convenience with Natural Gas power

While eliminating one of the two biggest hurdles to building a Green Grid

Solar Thermal's use of diminishing desert water supplies & its impact upon birds

*(Written / Revised: November 2019)*

# *Solar Thermal Power & Heat Storage*

*First, a necessary digression:*

There are **concentrated** forms of **Solar Photovoltaic Power** <sup>1</sup>

And this note set includes **un-concentrated** forms of **Solar Thermal Power**

But as inaccurate and misleading as it may be, Solar Thermal Power

is often given the blanket label of **Concentrated Solar Power (CSP)**,

especially by people in (or associated with) its industrial application

Why? Because **outside of research labs & prototype development projects**,

**industrial** Solar Thermal Power IS still ~ 100% concentrated

while **industrial** Photovoltaic Power IS still ~ 0% concentrated

Nevertheless, for accuracy and clarity, I'll stick with the term **Solar Thermal Power**

(despite the widespread use of "CSP" and dozens of other cryptic acronyms)

*1) See my notes set: [Tomorrow's Solar Cells \(pptx / pdf / key\)](#)*

## *A very incomplete list Solar Thermal acronyms / terms :*

ARC	Anti-Reflection Coating	LFC	Linear Fresnel Collector
CPC	Compound Parabolic Concentrator	LFR	Linear Fresnel Reflector
CRS	Central Receiver System	NREL	(U.S.) National Renewable Energy Lab
CSP	Concentrating Solar Power	PCM	Phase Change Material
CSTP	Concentrated Solar Thermal Power	PT	Parabolic Trough
DCS	Distributed Receiver Systems	PT	Power Tower
DE	(Parabolic) Dish + Engine (System)	PTC	Parabolic Trough Collector
DNI	Direct Normal Incidence	PTR	Parabolic Trough Reflector
DOE	(U.S.) Department of Energy	SD	Solar Dish
DSG	Direct Steam Generation	ST	Solar Tower
EIA	(U.S.) Energy Information Agency	STE	Solar Thermal Energy
FOM	Figure of Merit	STEG	Solar Thermoelectric Generators
FR	Fresnel Reflector	STPV	Solar Thermophotovoltaic
HTF	Heat Transfer Fluid	STP	Solar Thermal Power
IR	Infrared	TCS	Thermochemical Energy Storage
ISCCS	Integrated Solar Combined Cycle System	TES	Thermal Energy Storage
LCOE	Levelized Cost of Energy	TPV	Thermophotovoltaic
LEC	Levelized Electricity Cost		

*Colors highlight acronyms / terms that are redundant (or virtually redundant)*

# *Solar Thermal Power Plants **look** very different than other power plants*

But functionally, they are almost identical to fossil fuel, biofuel & nuclear power plants <sup>1</sup>

All of which include (working backwards):

- 4) **Electrical Generators** driven by
- 3) **Propellers** (in complex versions known as "turbines") which are propelled by
- 2) **Steam** rushing out of water-filled **Boilers** due to the presence of a
- 1) **Heat Source** - Which is the **only thing really differing** between these plants

*The generators, turbines & boilers are virtually (if not completely) identical!*



(1)

1) See my note set about Generic Power Plants ([pptx](#) / [pdf](#) / [key](#))

For their heat Solar Thermal plants require **mirrors** (and sometimes smoke <sup>1)</sup>)

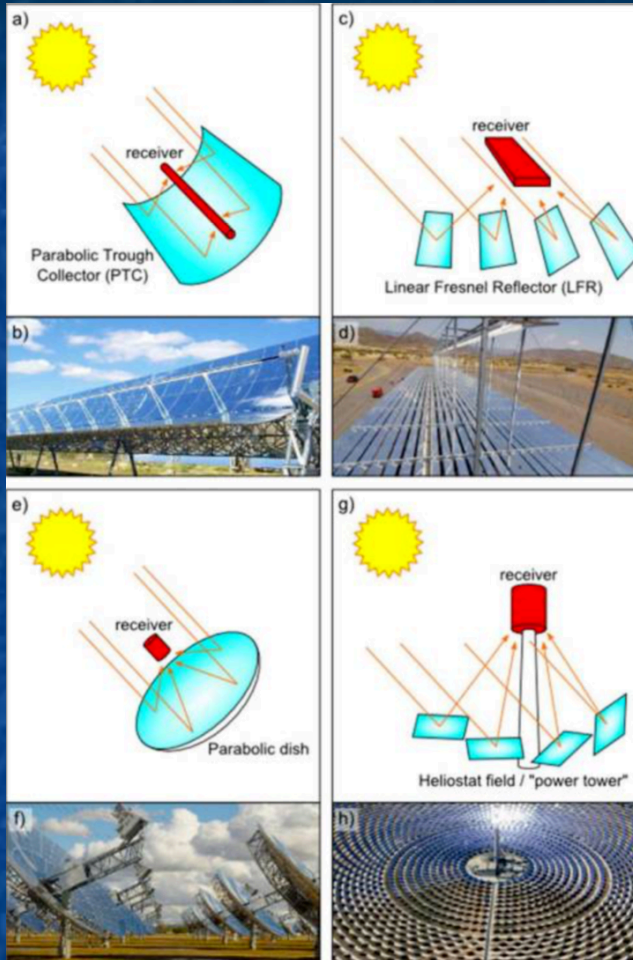

**Parabolic mirrors focus light from ONE direction**

The sun in our sky appears quite small, so its light is almost ideally focused by such mirrors

These mirrors can be 2D "parabolas" (top figures)

Or 3D "paraboloids" (bottom figures)

They can be a single continuously curved shape (left)

Or divided into separate almost-flat facets (right)

**Solar Thermal plants use all four combinations**

But for now, the key point is that . . .

*1) Many of today's solar thermal plants must be kick-started every morning by burning natural gas (as discussed later in this note set)*

*Without such focusing (concentration) sunlight cannot boil water!*

Which would eliminate the possibility of steam-generated Solar Thermal Power

***But concentration has a very significant downside:***

While **photovoltaic solar cells** also use sunlight coming directly from the sun, they can simultaneously absorb **scattered sunlight** coming from elsewhere (such as that from **thin clouds, haze, or even clear blue sky**)

In contrast, parabolic mirrors collect light from **ONLY ONE DIRECTION** effectively ignoring sunlight scattered from across the sky

That scattered sunlight, while generally weaker than direct sunlight, nevertheless delivers a good fraction of the sun's energy to the earth's surface

**This fraction of solar power is lost to concentrating solar thermal power plants**

**Which are therefore built in locations where sunlight scattering is minimal**

# TOTAL Average Daily Solar Energy Incident Upon the U.S.:

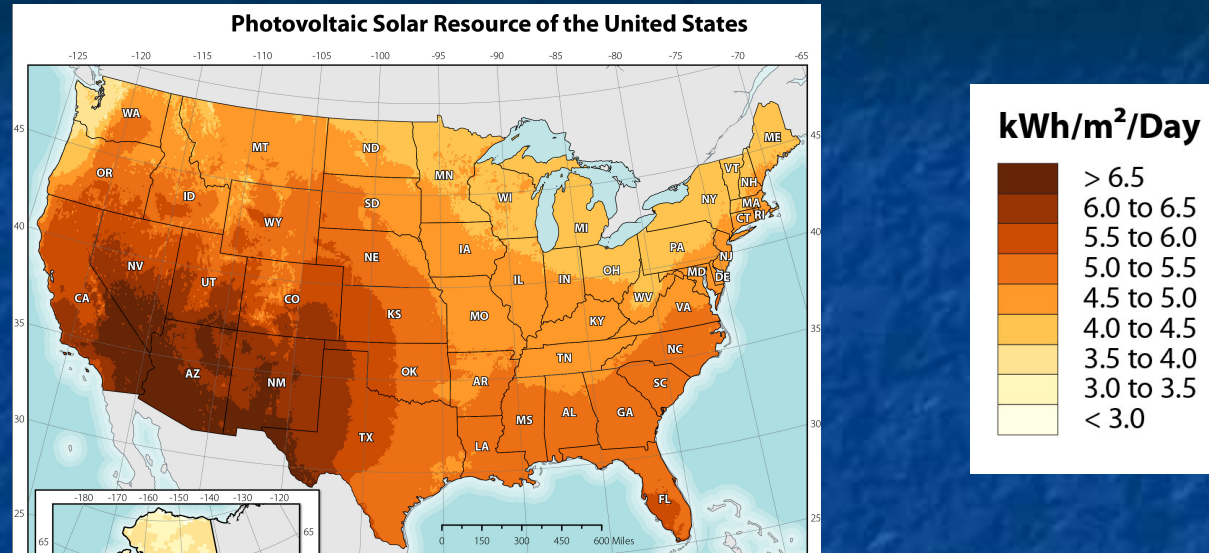

This daily and annually averaged solar "insolation" **from all sky directions** is:

**Weak** in New England and the upper Midwest

**Medium** in South and lower Midwest

**High** in the West

**Very High** across the Southwest

# Vs. DIRECT Average Daily Solar Energy Incident Upon the U.S.:

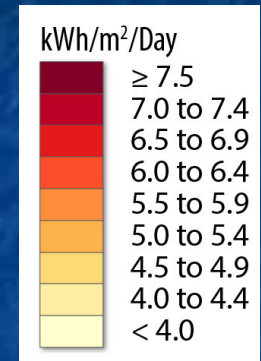
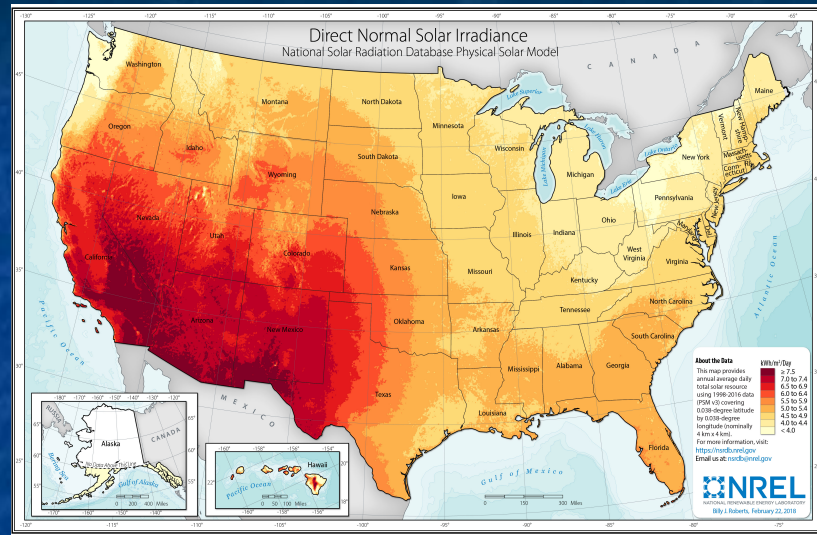

*NOTE: While very similar to the color coding of the previous map, the coding here is NOT identical*

Daily and annually averaged solar insolation **coming straight from the sun** is:

**Very Weak** in New England and almost all of the Midwest

**Weak** in the South

**Medium** in the West

**Highest by far** in the deserts of New Mexico, Arizona, S Nevada, SE California



*Solar Thermal Plants are built **only** in such near-ideal desert locations*

And even there, today's complex Solar Thermal Plants must still be subsidized

In contrast, Solar PV is already cost-effective, even in less than ideal sunlight

And by locating some Solar Photovoltaic plants near our metropolitan areas

we postpone upgrading our long-distance power transmission grid

**But way out in those dry deserts, Solar Thermal plants ARE STILL steam plants**

ALL steam plants recycle the steam's water by cooling and re-condensing it

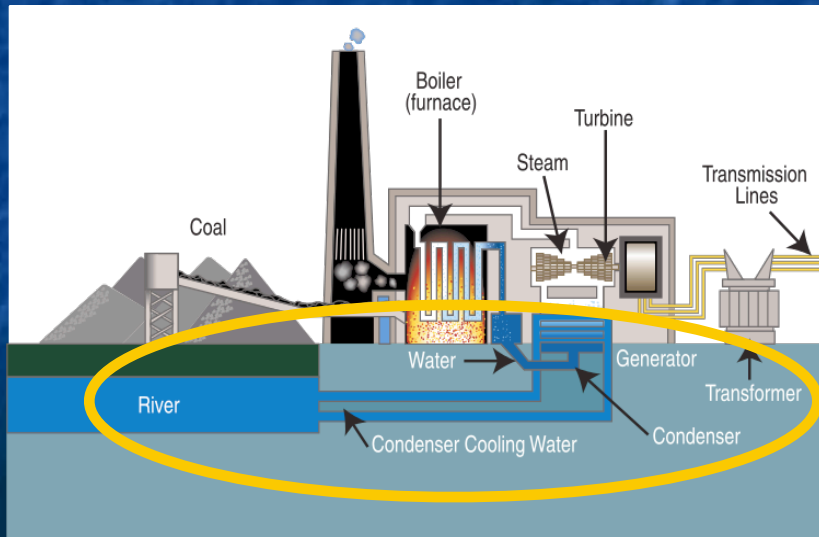

But WATER generally supplies that cooling  
Often a LOT of water, such as a river or lake

**Desert Solar Thermal Energy will thrive  
ONLY if such water use is eliminated**

*(As discussed near the end of this note set)*

Figure from my note on Fossil Fuel Power plants ([pptx](#) / [pdf](#) / [key](#))

Source: [http://en.wikipedia.org/wiki/Fossil-fuel\\_power\\_station](http://en.wikipedia.org/wiki/Fossil-fuel_power_station)

# *Ways of Concentrating and/or Collecting Solar Thermal Energy*

*Let's first take a look at several novel schemes:*

**The first two schemes would reduce or even eliminate solar concentration**

How? By eliminating the use of steam in favor of

the natural convection of heated (or cooled) masses of air

**Solar Chimney / Thermal Updraft Tower** plants have much smaller concentrators <sup>1-3</sup>

As seen in this early prototype built in Manzanares, Spain: <sup>2</sup>

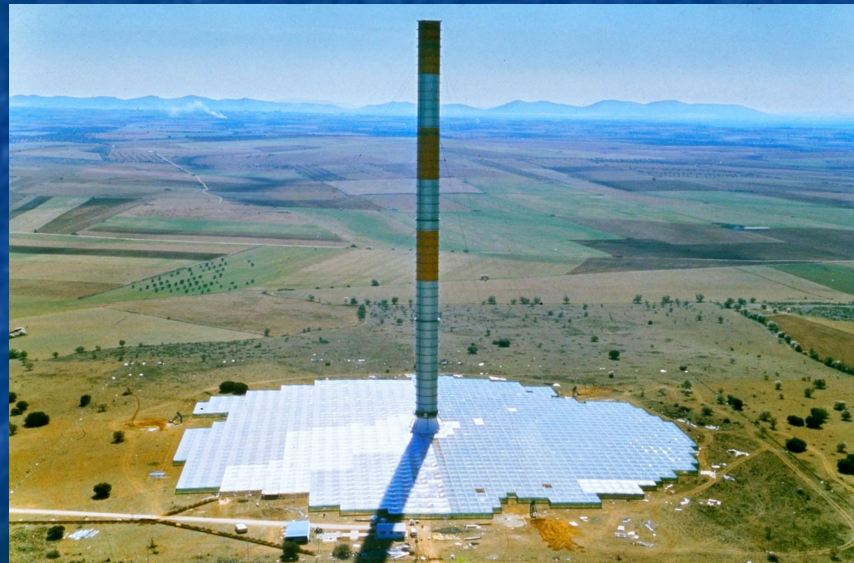

1) Wikipedia - Solar Updraft Tower - [https://en.wikipedia.org/wiki/Solar\\_updraft\\_tower](https://en.wikipedia.org/wiki/Solar_updraft_tower)

2) Solar Chimneys Can Convert Hot Air to Energy - But Is Funding a Mirage?, T.K. Grose, National Geographic, April 2014

3) A Review of Solar Chimney Power Generation Technology, A. Dhahri & A. Omri, Int. J. Eng. & Adv. Tech. 2(3), pp. 1-17 (2013)

*They heat air below a greenhouse-like transparent canopy*

That heated air's lower density causes it to rise along the canopy's sloping roof until it reaches, and rapidly accelerates up, the central chimney which incorporates a large **Wind Turbine Generator** in its base

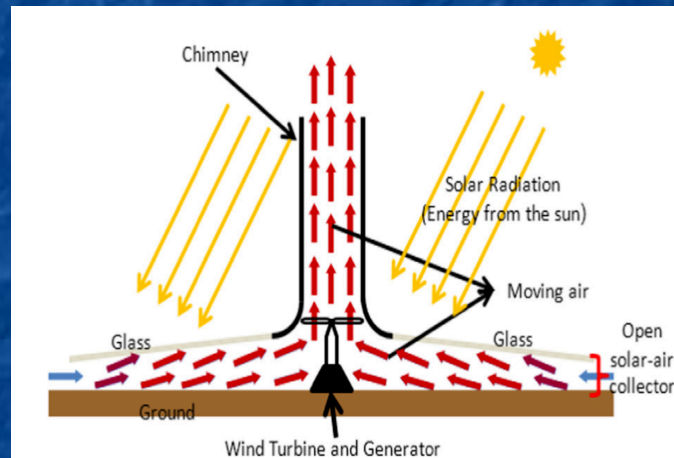

*1) Historic and Recent Progress in Solar Chimney Power Plant Enhancing Technologies, Al-Kayiem et al., Renewable and Sustainable Energy Reviews 58, pp. 1269-92 (2016)*

From 195 meter Manzanares chimney successfully produced up to 50 kW of power <sup>1,2</sup>

But cost-cutting on the prototype (e.g., thin 1.25 mm rust-susceptible iron walls)

weakened the tower, leading to its destruction in a 1989 wind storm

Other prototypes have been built or planned in China, Australia, Africa & Spain

But a full-scale commercial version has yet to be funded and built

*2) A Review of Solar Chimney Power Generation Technology, A. Dhahri & A. Omri, Int. J. Eng. & Adv. Tech. 2(3), pp. 1-17 (2013)*

## *Concentration is **eliminated** & air flow **reversed** in a second scheme:*

Proposed at Israel's Technion U. <sup>1,2</sup> & promoted by Solar Wind Energy Tower Inc, <sup>3</sup>

this as-yet-untested scheme has no canopy or collector of any sort

Further, the only solar heating involved is that of naturally solar-heated desert air

But in that desert, a **1 km tall** chimney would be built, and at its top opening

water would be sprayed inward (even salty nearby Mediterranean water)

to cool and densify that desert air causing it to fall **DOWN** the chimney

which would have many small wind turbine generators around its base



*Artist's conception <sup>3</sup>*

1) *Energy Tower (Downdraft) - Wikipedia (and references therein)*

2) *Solar Thermal Power Technologies - B.J. Groenendaal, VLEEM Project, 2002*

3) *<http://www.solarwindenergytower.com/the-tower.html>*

*According to its proponents, such a **Downdraft Chimney / Tower:***

Would require so little surrounding desert that, for the same power output,  
its installation would be much smaller than other forms of Solar Thermal Power  
Indeed, the claimed footprint would rival that of fossil-fuel power plants

**allowing for the possibility of closely spaced farms of such towers**

Further (apparently in unpublished conference presentations) it was suggested that  
**seawater de-salinization could become an integral part of such farms**

My best guess as to how: Saltwater spray at the tower's top would partially evaporate,  
producing falling salt-enriched droplets + cooled downdraft air + water vapor

At the tower's base salt-enriched droplets would fall to the ground (into ponds?)  
while air + water vapor passing through the turbines could continue outward  
to where the water vapor could be condensed out of the air as pure water

# *Is this so called SNAP<sup>1</sup> idea intriguing? Absolutely*

But a **huge number of questions** have yet to be answered

Answers that will require construction and testing of a real-world prototype

Issues include:

Cost and survivability of 1 km tall chimneys in sandstorm-prone deserts?

Cost of continuously pumping seawater 1 km skyward?

Salt corrosion damage to inside of the chimney and turbines around its base?

Is power generation feasible only when it's combined with desalinization?

Or could power production alone justify construction of such plants?

*A final scheme is "novel" only in that it is not now used commercially*

But ignoring certain bothersome practical & economic considerations, it is in fact the **gold standard** against which other Solar Thermal technologies are compared

It is thus worth itemizing its scientific and technological strengths,

while identifying shortcomings that have thus far blocked its commercialization

The technology in question? **Solar Thermal Power based on Paraboloid Dishes**

Less pedantically called **Parabolic Dishes**

Or even more frequently, just **Dishes**

*Photo used in article about the proposed (but since shelved)  
Calico California solar project*

**"Mirrored Solar Dishes to March Across California Desert"**  
<http://www.ens-newswire.com/ens/oct2010/2010-10-20-091.html>





*As noted above, "paraboloid" mirrors have the ideal light-gathering shape*

**Lenses** can also focus light, but they are subject to **chromatic aberration**

Which means that they bend different colors into slightly different directions

Instead, **mirrors** bounce all colors identically, yielding a sharper (more intense) focus

Further, while a large paraboloid **mirror** can be fully supported from behind,

**lenses** must be supported at only their edges, causing large and heavy

**lenses** to flex, distorting their shape, or even breaking those edges

*Which explains why **all large optical telescopes use mirrors***

**Solar Thermal Dishes** focus sunlight so well that it is concentrated by ~ **1000 X**

Which can heat fluids to **1200°C** <sup>1, 2</sup>

**1200°C is BRIGHT WHITE HOT**

***Way hotter than required to boil water!***

1) *Concentrating Solar Power, Weinstein et al., Chemical Reviews 115, pp. 12797-12838 (2015)*

2) *Concentrating Solar Power, Solar Energy Industries Association*

*That heat **could** be collected and pumped away - for use elsewhere*

At the dish's focal point you'd install a **Receiver** filled with **Heat Transfer Fluid** <sup>1-3</sup>

The fluid would then transfer heat to remote steam-turbine generators

Those **Heat Transfer Fluids** would have to:

Carry a lot of heat energy per volume (have a "high heat capacity")

Pump easily (have "low viscosity")

Withstand the intense midday temperatures of Solar Thermal concentrators

But not solidify (or become un-pumpable) after things cool down overnight

**MOST Solar Thermal Plants DO use Heat Transfer Fluids which include:**

**Synthetic oils, molten salts, highly compressed gases,**

**ceramic powders or sand suspended (or falling through) gases,**

**and perhaps in the future: specially engineered nanoparticles**

1) *Concentrating Solar Power*, Weinstein et al., *Chemical Reviews* 115, pp. 12797-12838 (2015)

2) *Heat Transfer Fluids for Concentrating Solar Power Systems – A review*, Vignarooban et al., *Applied Energy* 146, pp. 383-96 (2015)

3) *Advanced Heat Transfer Fluids for Direct Molten Salt Line-Focusing CSP Plants*, Bonk et al., *Progress in Energy & Combustion Science* 67, pp. 69-87 (2018)

*But heat transfer fluids **don't** work well for Dishes:*

**ALL** Solar Thermal concentrators must track the sun across the sky

But the focus of a **Dish** is particularly sharp and precise (which is its strength!)

and a heat-absorbing **Receiver** must be to be locked into that focal point

That would require the Dish and Receiver to be built into a carefully aligned assembly

which would then pivot as a single unit as it tracked the sun

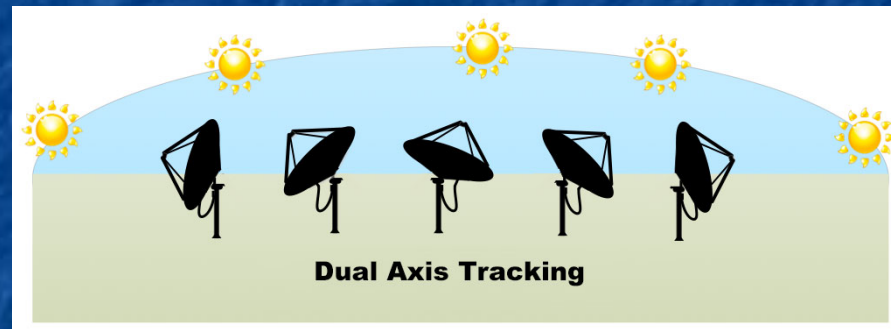

Figure: <http://www.solartronenergy.com/solar-concentrator/how-does-a-solar-concentrator-work/>

## THE PROBLEM?

Getting **1200°C Heat Transfer Fluid** out of that **Receiver** & down to the ground

so that it can be sent onward to boil water for a steam turbine generator

*You can't just send 1200°C fluids through hoses!*

Conventional rubber hoses would melt, and even silicone hoses would quickly fail

And while high-temperature **metals pipes** might survive, they would have to be connected via **swivel joints** to allow for the mirror's two-axis sun tracking (and deprived of rubber "O-rings" the joints would be very prone to leakage)

**Dishes thus employ a COMPLETELY UNIQUE power generation scheme:**

A weird **thermal engine** is placed in a Dish's focal point and coupled to a small **electrical generator**, which sends electricity out a **cable**

This is all labeled **Dish Engine (DE) Solar Thermal Power** <sup>1, 2</sup>

For which the sun-tracking movement of the **Dish + Engine + Generator Assembly** is accommodated by the **Generator's** flexible electrical output cable

*1) Concentrating Solar Power, Weinstein et al., Chemical Reviews 115, pp. 12797-12838 (2015)*

*2) Solar Parabolic Dish Stirling Engine System Design, Simulation, and Thermal Analysis, Hafez et al., Energy Conversion & Management 126, pp. 60-75 (2016)*

# The weird engine? It's a "Beta-type Stirling Engine"

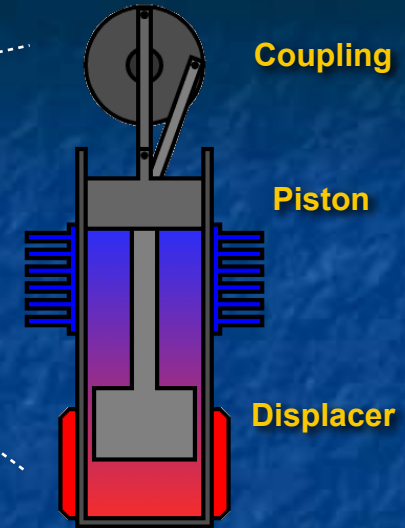
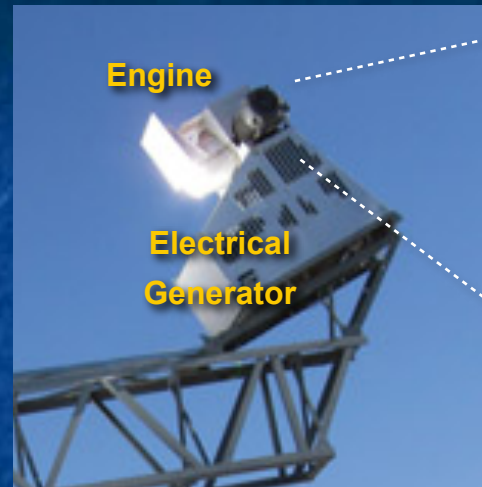

The Stirling Engine is a sealed and self-contained unit that is filled with a gas

It has no incoming fuel lines nor outgoing exhaust ports

Its input energy comes ONLY from sunlight focused on the **outside** of its **HOT** end

Inside are a very loosely fitting **displacer** and tightly fitting **piston**

Pressure differences across the displacer try to push it up or down

But the displacer is also **coupled** to the upper tightly-fitting piston

The displacer is thus moved by BOTH pressure differences AND by the piston

## Setting this Stirling Engine in motion:

Heated gas below the displacer expands, driving the displacer upward

But now expanding, that gas in the lower chamber begins to cool

It also leaks around the loosely fitting displacer into the upper chamber

As the displacer rises, the coupling also lifts the piston

While gas continues to leak around the displacer

The displacer reaches the top of its travel but the coupling drives the piston higher

This expands the upper chamber, causing its gas to cool,

The engine's **COOL** walls also cool the gas, which then rapidly contracts

This sucks the piston sharply downward

which, through the coupling, also sends the displacer downward

Completing a cycle that will now repeat as long as heat is applied

***PgDn starts the animation (now, hopefully, at least somewhat plausible)***

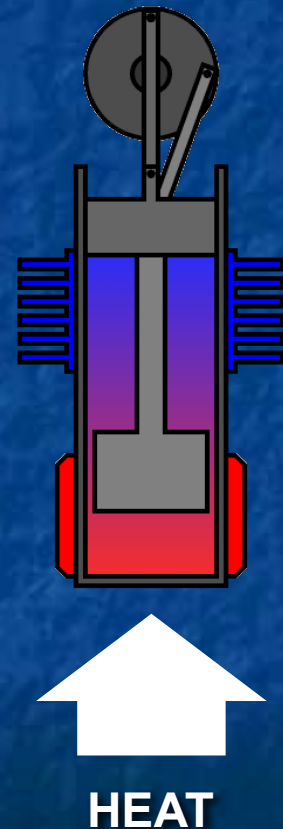

*The animation is from Wikipedia's "Stirling Engine" webpage The animator is credited as: "YKTimes"*

*See also: Single Cylinder Stirling Engine, Animated Engines.com*

# *Solar Thermal power plants are ALL examples of **thermal engines***

As discussed in my note set about Generic Power Plants ([pptx](#) / [pdf](#) / [key](#)),

thermal engines cycle a fluid through temperature to do some sort of work

The idealized "Carnot Cycle" predicts the **maximum efficiency** of a heat engine:

Work Energy Out / Heat Energy In =  $\Delta$  Temperature / (Highest Temperature)

For a **Dish Engine**, the relevant temperatures are those of the engine's ends:

The Stirling Engine's hot end is at 1200°C (1473°K)

And I'll guess that the cold end might not rise above 200°C (473°K)

With those temperatures, the Carnot Cycle model predicts:

Max Dish-Engine Efficiency =  $1000^{\circ}\text{K} / 1473^{\circ}\text{K} = 0.67 = 67\%$

Real-world D-E efficiencies are ~ 29-32% <sup>1</sup> (demonstrating the Carnot Model's weakness)

**By achieving the highest temperatures of ANY Solar Thermal Technology**

**Dish Engines achieve the field's highest power conversion efficiencies**

*1) For details see Review, Dish & Stirling Engine papers linked from this note set's Resources webpage ([link](#))*

## *Disadvantages of Dish-Engine Solar Thermal Plants?*

**This photo hints at a few:**



[https://  
www.buildinggreen.co  
m/news-article/stirling-  
suncatcher-heat-  
engine-technology](https://www.buildinggreen.com/news-article/stirling-suncatcher-heat-engine-technology)

Erect Dish Engine assemblies are exceptionally susceptible to desert wind damage

The shape of DE units makes necessary cleaning of their mirrors particularly awkward

To avoid interference and facilitate cleaning scaffolds, Dishes must be very widely spaced

That, as evident in all the sunny ground above, wastes a **lot** of solar energy

The uniqueness of Solar Dishes & Stirling Engines eliminates economies of scale

This contrasts with most other Solar Thermal Schemes which make heavy use of standard or semi-standard heat-exchangers, steam-turbines and generators

**For these (and other) reasons, Dish Engines have fallen out of commercial favor**



*Solar Towers*  
*Power Towers*  
*Central Receivers*

*(three names for the same thing)*

# Only slightly less efficient than Dishes are **Solar Towers**

Which are also called **Power Towers** or **Central Receiver Systems**

Here as shown schematically & pictorially in the U.S. Department of Energy report:

## 2014 - Year of Concentrating Solar Power

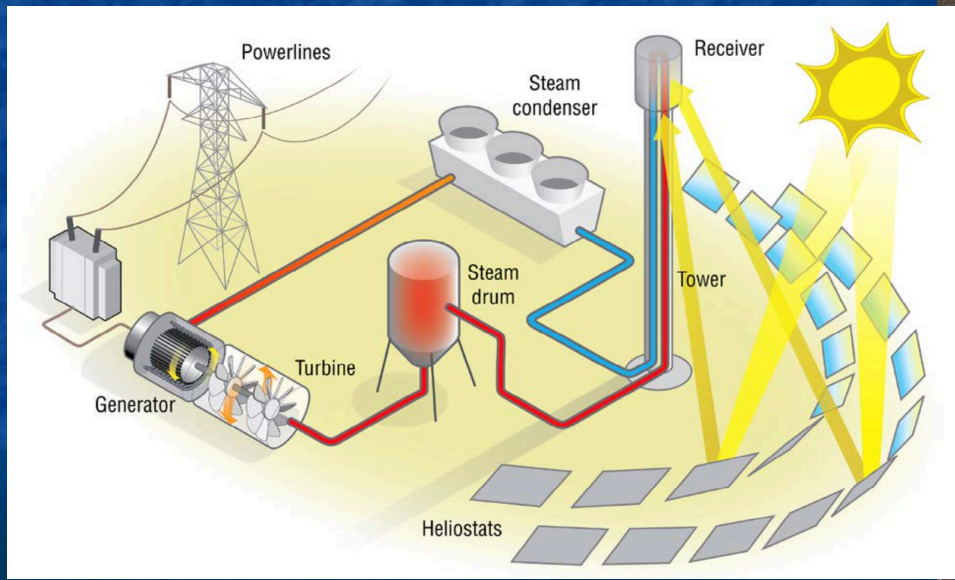

*These concentrators are like cut-up and flattened Dishes:*

Ideal continuous focusing parabolic mirror:

Approximation of it using flat mirror facets,  
which are called **Heliostats**

Lower Heliostats to mount them atop poles  
But they no longer focus the sunlight!

Tweaking their tilts to recover the focus:

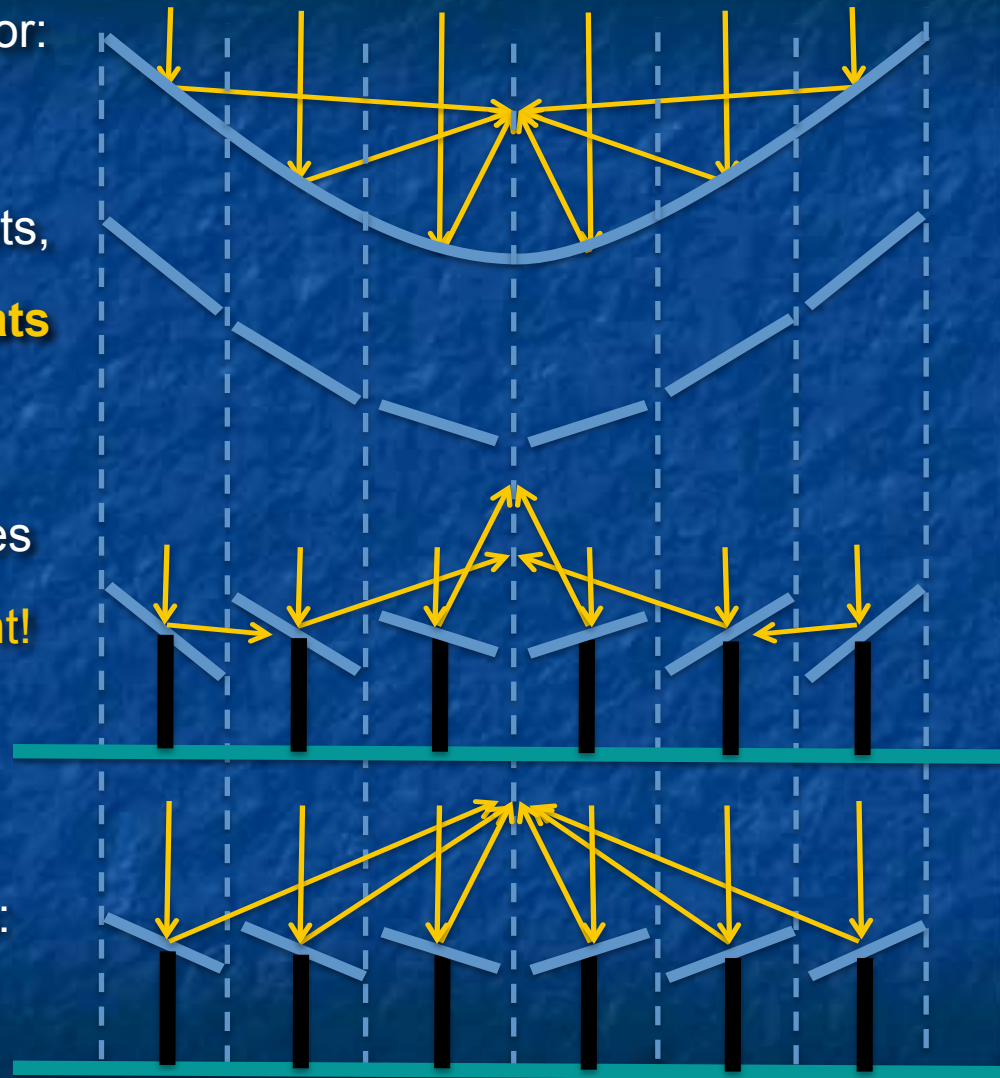

But this is done in 3D . . . using a **WHOLE LOT of Heliostats**

This concentrator, one of three at the Ivanpah California Solar Thermal plant, uses almost **60,000 Heliostats** (each actually consisting of a pair of mirrors) <sup>1</sup>



"2014 - Year of Concentrating Solar Power" - D.O.E.



[www.naturepl.com/stock-photo-nature-image01596527.html](http://www.naturepl.com/stock-photo-nature-image01596527.html)

Not only must computers calculate the correct tilt for every single Heliostat, but to adjust for the sun's motion tilts must be re-computed second-by-second, with results used by two-axis tilting mechanisms at **every single** Heliostat:

**[60,000] x [Celestial mechanics + Reflection geometry] x [Repeat every second]**

*Explaining why so many Heliostats seem to be MISALIGNED in DOE's photo on the left?*

1) *Ivanpah Solar Power Facility - Wikipedia*

*Which brings us to the **Solar Tower** itself  
(also known as the **Power Tower** or **Central Receiver**)*

These photos suggest that two very different strategies are being employed:

Spain's PS20 plant puts **Solar Towers** at the **SIDE** of its Heliostat fields

California's Ivanpah puts **Solar Towers** at the **CENTER** of its Heliostat fields

**WHAT'S GOING ON?**



**Planta Solar 20 (PS20), near Seville Spain**  
<https://www.amusingplanet.com/2013/08/the-solar-power-towers-of-seville-spain.html>

**Ivanpah Solar Thermal Plant, Mojave Desert of California**  
<https://www.pinterest.com/pin/488992472012861561/>

# It's all about **RETAINING** power that Heliostats direct to the tower

Explanations require a bit of scientific review:

**The hotter an object gets the more intensely it radiates away energy as light, and that radiation also shifts towards higher energy colors (i.e., towards shorter wavelengths such as blues & violets)**

Scientists call this **black body** behavior

For objects at different temperature they calculate curves such as those below

Loss (area under a curve) increases as **(object temperature)<sup>4</sup>**

Curves peak at wavelength =  **$2896 \mu\text{m} / (\text{object temperature})$**

these being "absolute temperatures" measured in °K

For details see my: **Greenhouse Effect** ([pptx](#) / [pdf](#) / [key](#))

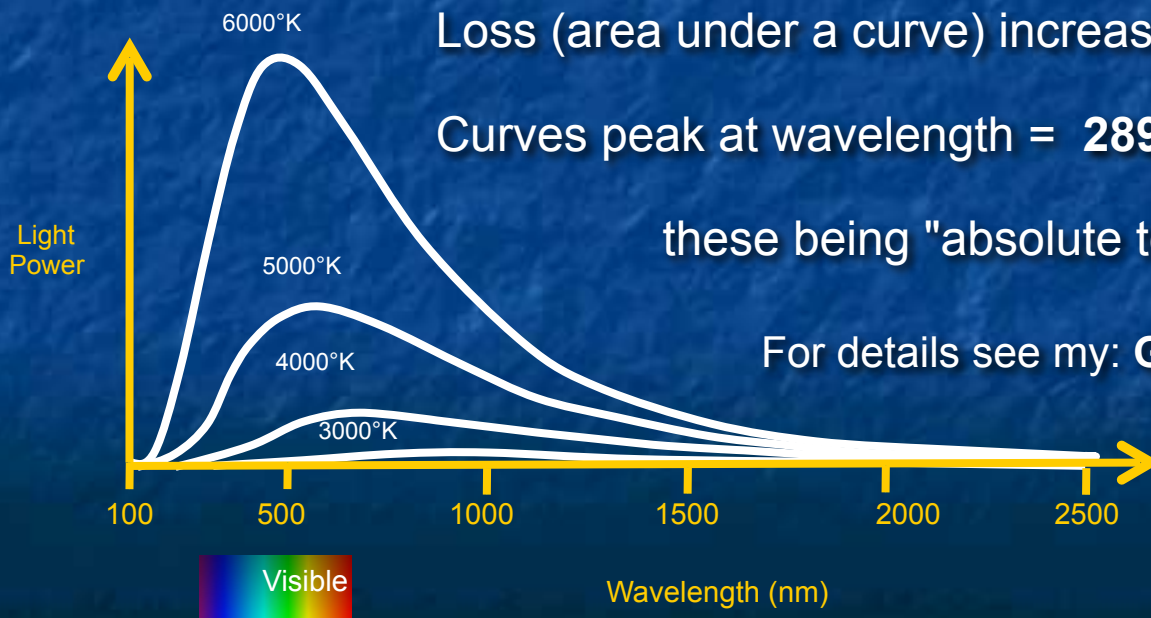

## *Side towers try to physically **trap** the sunlight's energy*

Light beams pass through a single portal in the side tower, striking its inner surfaces

Those heat-absorbing surfaces make up what is then called a **Cavity Receiver**

Those heated surfaces DO still try to re-radiate energy outward in all directions,

but MOST of those directions don't lead back through the cavity's portal,

and energy missing the portal is just re-absorbed elsewhere in the Receiver

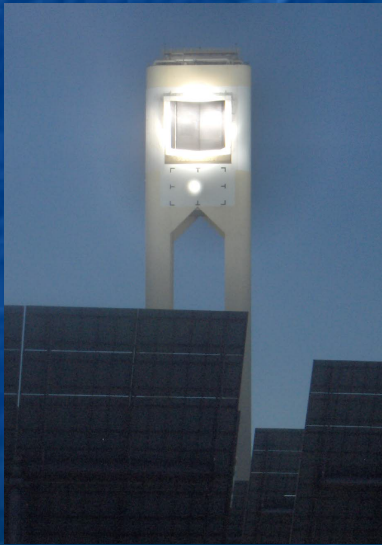

*Left: <http://sine.ni.com/cs/app/doc/p/id/cs-11550>*

*Center: <https://ojozi.wordpress.com/2010/02/22/solar-power-tower/>*

*Right: Review of High-Temperature Central Receiver Designs for Concentrating Solar Power, Ho & Iverson, Renewable & Sustainable Energy Reviews (29), pp. 835-836 (2014)*

## *Side towers + cavities work best north or south of the equator*

Where the sun naturally slants in from the south or north (respectively)

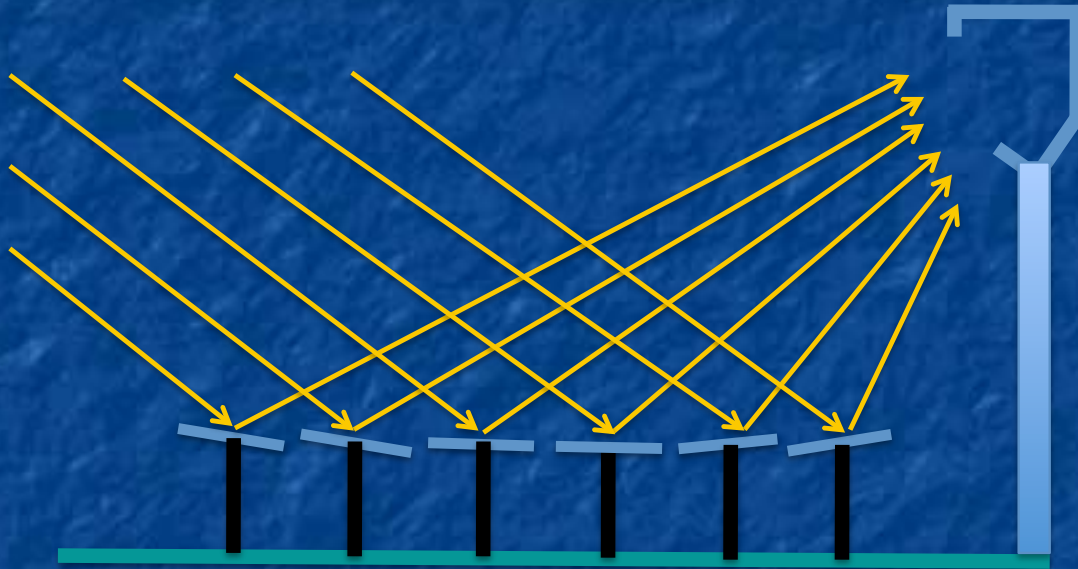

But a taller Tower is then desirable as it allows for **flattened** Heliostat **tilts**,  
reducing the amount of sunlight slipping **between** Heliostats to the ground

However, increased Heliostat-Receiver separation also calls for an enlarged Receiver  
which can suffer increased re-radiation of power out its enlarged cavity portal



*Open on all sides, Central Receivers must suppress re-radiation differently*

So they dig even deeper into the science of how power is lost via light re-emission:

Black body laws are idealized, including the **Stefan Boltzman Law**

which states that total energy radiated =  $\sigma$  (Temperature)<sup>4</sup>

where  $\sigma = 5.670 \times 10^{-8} \text{ W/m}^2/(\text{°K})^4$

But we all KNOW how to CHANGE the amount of light coming from an object:

You only have to paint it a different color, or change its material or texture!

**So why not change the Receiver's color or texture to REDUCE light emission?**

Physicists then drag out **Kirchhoff's Law of Thermal Radiation** which states that <sup>1</sup>

decreasing a surface's light **emission**, also decreases its light **absorption**

*Suppressing a Receiver's heat emission would thus hurt its sunlight absorption!*

1) *Concentrating Solar Power*, Weinstein et al., *Chemical Reviews* 115, pp. 12797-12838 (2015)

*But like so many laws, this Kirchoff Law has a gaping loophole:*

It applies only color by color, for example:

A paint or texture can cut an object's emission & absorption of **RED** light

But that doesn't have to affect its emission & absorption of **BLUE** light

**The Sun's surface is at just over 6000 °K**

**But its light heats Central Receivers to no more than 1000 °C (1273 °K)**

Recall that Black body emission/absorption peaks at **2896  $\mu\text{m}$  / (object temperature)**

**So while Sunlight peaks at  $\sim 0.48 \mu\text{m} = 480 \text{ nm}$**

**the heated Receiver's light peaks at  $\sim 2.3 \mu\text{m} = 2300 \text{ nm}$**

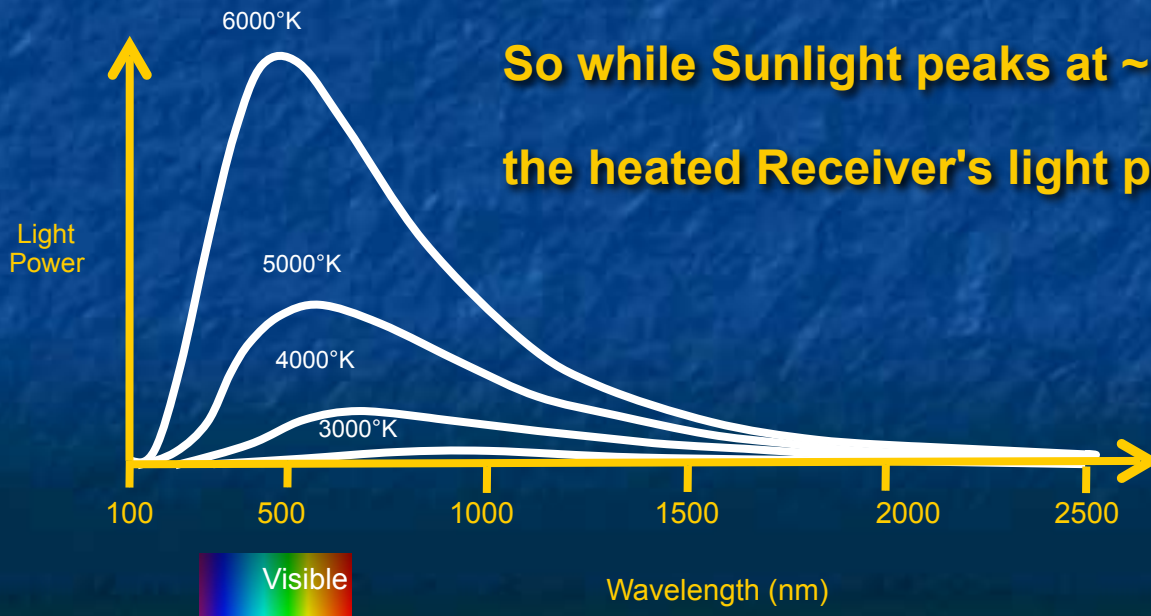

## Putting this all together:

Via paint, texture or material, just alter the surface of a **Central Receiver** so that:

Light absorption / emission are **MAXIMIZED** for  $\sim 500$  nm visible light

Light absorption / emission are **MINIMIZED** for  $\sim 2500$  nm infrared light

Finding or preparing proper surface treatments is thus a **hot research topic** <sup>1</sup>

**Various Central Receivers** (Crescent Dunes NV, Ivanpah CA and Solar One CA):

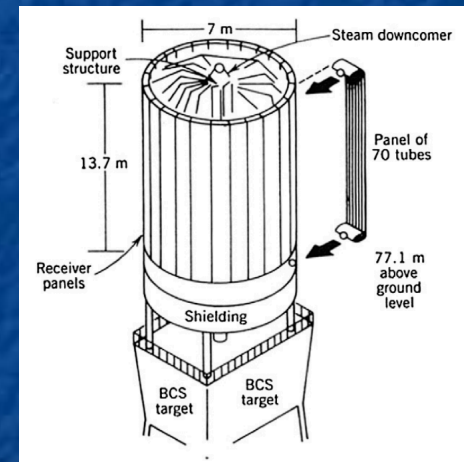
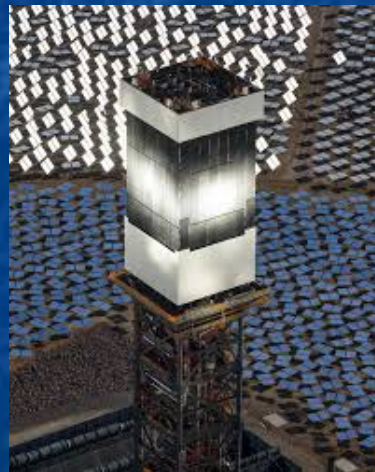

1) *Concentrating Solar Power*, Weinstein et al., *Chemical Reviews* 115, pp. 12797-12838 (2015) Left Photo: <http://www.basinandrangewatch.org/CrescentDune.html>

Center Photo: 2014 - *The Year of Concentrating Solar Power* - US DOE

Right Photo: *A Review of Thermal Collectors and Thermal Energy Storage in Solar Thermal Applications*, Tian et al., *Applied Energy* 104, pp. 538-53 (2013)

# Early Solar Tower Receivers used Direct-Steam-Generation (DSG)

One pioneering project was the **Solar One** plant built in Southeast CA (near Barstow)  
*(not to be confused with very different "Solar One" projects in Nevada & Spain)*

In 1981 it was claimed to be the world's first "**large-scale**" Solar Thermal plant <sup>1</sup>

Meaning that its 1,818 mirrors produced **10 MW** of output power <sup>2</sup>

Its receiver was filled with water, which sunlight converted directly into steam

By NOT employing an intermediate Heat Transfer Fluid (HTF),

**Solar One** required no Heat Exchangers (HTF to water)

And its mirrors & black receiver alone replaced a steam boiler

Additional data on Solar One's performance was very hard to find

But I learned that soon after it, using similar Direct-Steam-Generation (DSG),

**Spain's Planta Solar 10 & Planta Solar 20** installations generated

**250-300 °C** steam at 45 bar (~ 45 atmosphere) pressures <sup>3</sup>

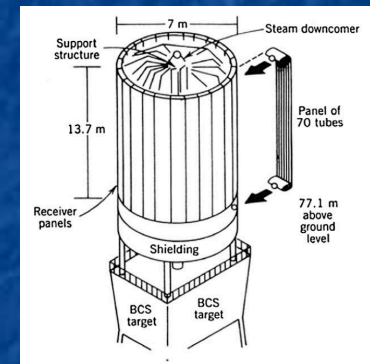

1) "The Solar Project" - Wikipedia - [https://en.wikipedia.org/wiki/The\\_Solar\\_Project#Solar\\_One](https://en.wikipedia.org/wiki/The_Solar_Project#Solar_One)

2) [http://www.solaripedia.com/13/31/solar\\_one\\_and\\_two\\_\(now\\_defunct\).html](http://www.solaripedia.com/13/31/solar_one_and_two_(now_defunct).html)

3) *Advances in Central Receivers for Concentrating Solar Applications*, C.K. Ho, *Solar Energy* 152, pp. 38-56 (2017)

# 30 years later DSG was scaled upward at California's Ivanpah Plant

Which is today's largest Solar Thermal Plant, using **three** Solar Towers

to produce **392 MW**, at a **record 29% conversion efficiency** (for Towers) <sup>1</sup>

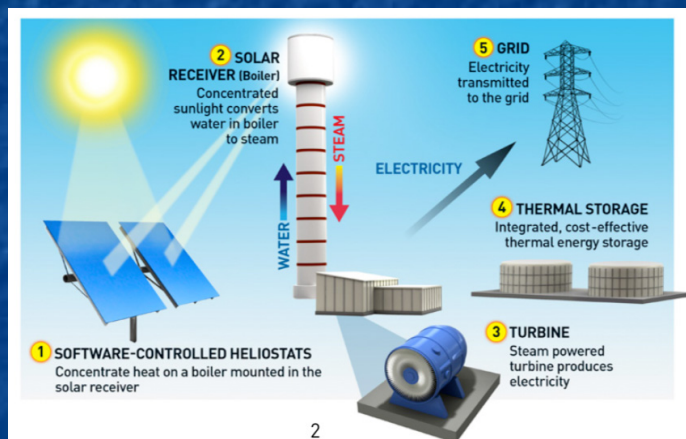

Ivanpah's enhanced Direct-Steam-Generation yields superheated steam at  $\sim 540\text{ }^{\circ}\text{C}$  <sup>2</sup>

But given water's limited ability to capture and store heat energy,

this still means that power generation ceases around sunset

and next morning before dawn **natural gas burners must be ignited**

to re-heat the plant's water back up to where sunlight can boil it

1) From NREL's plant listings: <https://solarpaces.nrel.gov/ivanpah-solar-electric-generating-system>

2) *Advances in Central Receivers for Concentrating Solar Applications*, C.K. Ho, *Solar Energy* 152, pp. 38-56 (2017)

Figure from: [http://www.brightsourceenergy.com/stuff/contentmgr/files/0/3eac1a9fed7f13fe4006aaab8c088277/attachment/ivanpah\\_white\\_paper\\_0414.pdf](http://www.brightsourceenergy.com/stuff/contentmgr/files/0/3eac1a9fed7f13fe4006aaab8c088277/attachment/ivanpah_white_paper_0414.pdf)

# Nevada's Crescent Dunes represents a potential breakthrough



Built near **Tonopah** in 2015 it produces **110 MW** - Only about 1/4 of **Ivanpah's** power!

But instead of water, its **Receiver** uses **molten salt** <sup>1</sup>

That **Heat Transfer Fluid** is piped down from the tower and sent to EITHER:

**Heat Exchangers** in which salt boils water into steam for the generators OR

**Two Storage Tanks**, each having a 13.6 million liter molten salt capacity <sup>2</sup>

**After sunset**, the stored salt can boil the generator's steam for **10 additional hours**,

while leaving that salt still above its ~ 200°C solidification temperature, <sup>3</sup>

keeping it pumpable and thus ready to re-enter service at sunrise

1) The *FIRST* commercial use of a molten salt central receiver was actually at Spain's 19 MW Gemasolar plant in 2011

2) From NREL's plant listing: <https://solarpaces.nrel.gov/crescent-dunes-solar-energy-project>

3) *Advances in Central Receivers for Concentrating Solar Applications*, C.K. Ho, *Solar Energy* 152, pp. 38-56 (2017)

# *Solar Thermal + Molten Salt = 24 / 7 Power (w/o carbon or nuclear)*

However, as detailed in my note set: **Power Plant Economics** ([pptx](#) / [pdf](#) / [key](#)):

**Even with storage, Solar Thermal is today's most expensive power technology**

**Not just** more costly than notoriously expensive Nuclear and Offshore Wind

**But also 3X** more expensive than our currently least expensive technologies of  
Combined Cycle Natural Gas, Solar Photovoltaics and Onshore Wind

And **without storage**, that disadvantage of 3X climbs to over **4X**

So we need to examine possible **FUTURE Central Receiver Solar Thermal technology**:

As discussed earlier, a **thermal engine's** theoretical "Carnot" efficiency limit is:

Maximum Conversion Efficiency =  $\Delta$  Temperature / (Highest Temperature)

But Ivanpah's steam AND Crescent Dune's molten salt top out at **540-565 °C**<sup>1, 2</sup>

Heliostat fields concentrate sunlight almost as effectively as Dishes (i.e., by ~ 1000X)<sup>3</sup>

**So why CAN'T Power Tower fluids reach comparable ~ 1000 °C temperatures?**

1) <https://solarpaces.nrel.gov/ivanpah-solar-electric-generating-system>

2) *Advances in Central Receivers for Concentrating Solar Applications*, C.K. Ho, *Solar Energy* 152, pp. 38-56 (2017)

3) *Concentrating Solar Power*, Weinstein et al., *Chemical Reviews* 115, pp. 12797-12838 (2015)

## The first reason is that today's Tower fluids can't withstand the heat

In water, chloride salts (e.g. table salt, NaCl) are notoriously corrosive

It's thus unsurprising that **molten** chloride salts are **HUGELY** corrosive

Crescent Dunes, and other Solar Thermal plants therefore employ nitrate salts

But nitrate salts break down above  $\sim 600$  °C, limiting Receiver temperatures

What are possible alternatives? Sandia National Labs <sup>1,2</sup> identifies these candidates along with their limits on incident solar intensity (flux) & operating temperature:

Heat transfer media	Peak flux (kW/m <sup>2</sup> )	Outlet temperature (°C)
Water/steam	$\sim 600$	390–560
Molten nitrate salt	$\sim 1000$	$\sim 600$
Liquid sodium	$\sim 2500$	$\sim 800$
Volumetric air <sup>a</sup>	$\sim 1000$	700–1000
Ceramic particles (direct heating)	$\sim 3000$ <sup>b</sup>	>1000

1) *Advances in Central Receivers for Concentrating Solar Applications*, C.K. Ho, *Solar Energy* 152, pp. 38-56 (2017)

2) *Review of High-Temperature Central Receiver Designs for Concentrating Solar Power*, Ho & Iverson, *Renewable & Sustainable Energy Reviews* (29), pp. 835-836 (2014)



*From that list - moving past today's water & nitrate salts:*

The next hotter would-be Heat Transfer Fluid is **liquid sodium**

As a molten liquid, sodium can be pumped through piping inside Receivers that are not much different from today's water and nitrate salt Receivers

Molten liquid sodium has thus long been tested as a Heat Transfer Fluid

in both experimental Nuclear Reactors and Solar Thermal Receivers

It can work well - But if it ever leaks, it spontaneously ignites in moist air

And it is thus associated with a number of Nuclear & Solar Thermal plant fires

Next on Sandia's list is **air** or (discussed in their papers) **other gases such as CO<sub>2</sub>**

With so few atoms, normal gases carry very little thermal energy

Solar Receivers would thus use gases pressurized to 15-25 bar

And because even pressurized gases tend to be transparent, sunlight would first be **absorbed** by porous solid structures through which the gas would be pumped

*The second reason is that today's fluids can't transport away enough heat*

For which the solution may be **solid Heat Transfer Fluids**

Solids, of course, have the highest possible density of heat-carrying atoms

Further, many "ceramic" solids can withstand tremendous temperatures

Typical ceramics include many metal oxides and carbides

**But "pumping" solid Heat Transfer Fluid through a Receiver has got to be tricky**

In this scheme, solid particles (even sand!) could shower down thru the sunlight

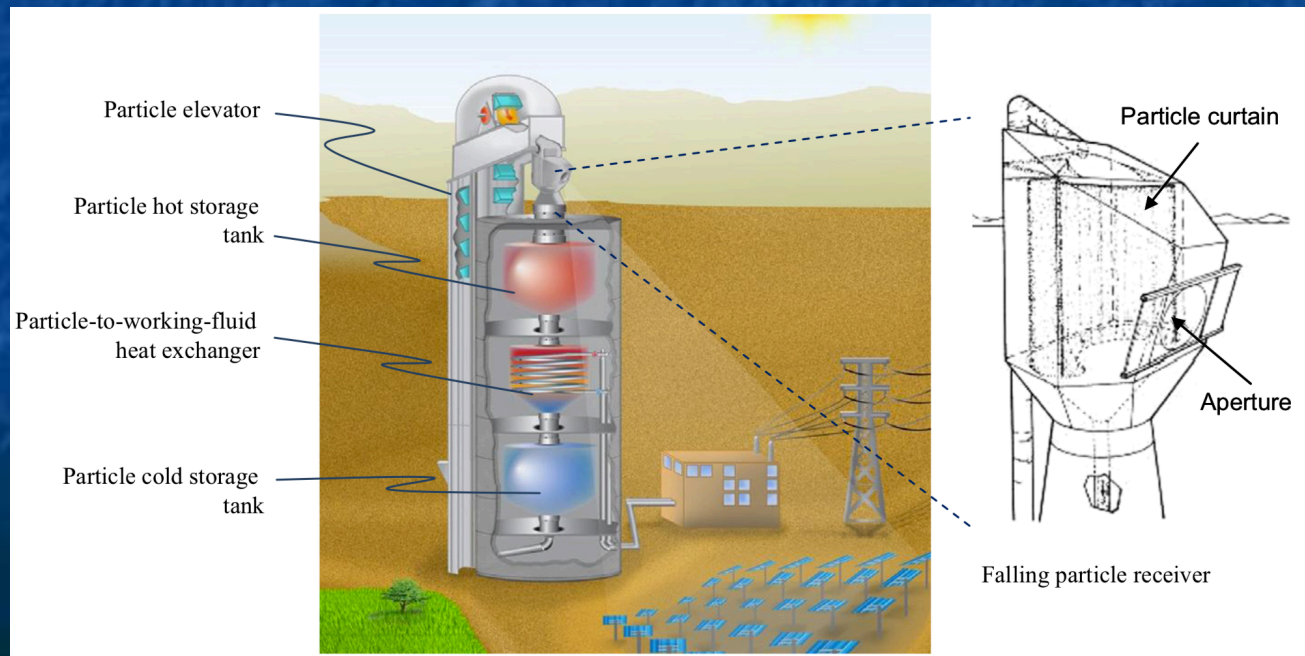

*1) Advances in Central Receivers for Concentrating Solar Applications, C.K. Ho, Solar Energy 152, pp. 38-56 (2017)*

## *In other schemes, solids would be "fluidized"*

"Liquid" **Quick Sand** is produced by flowing water driving solid sand particles apart

Solid powders can be similarly "fluidized" by pumping gas up through them

The EU's "Next-CSP" project animated their **Fluidized Powder Receiver** proposal 1

From which I have extracted and labeled this single frame:

- 1) **Dispenser** from which fluidized powder ascends (!!)
- 2) Passing through the **Solar Receiver** portal
- 3) Then descending into a **Hot Storage** container where it can be re-fluidized to pass into the
- 4) **Air Heater** where air is a secondary heat transfer fluid which is sent out to drive the generator's turbine
- 5) Powder is finally re-fluidized & sent to **Cold Storage** before being released to begin another cycle

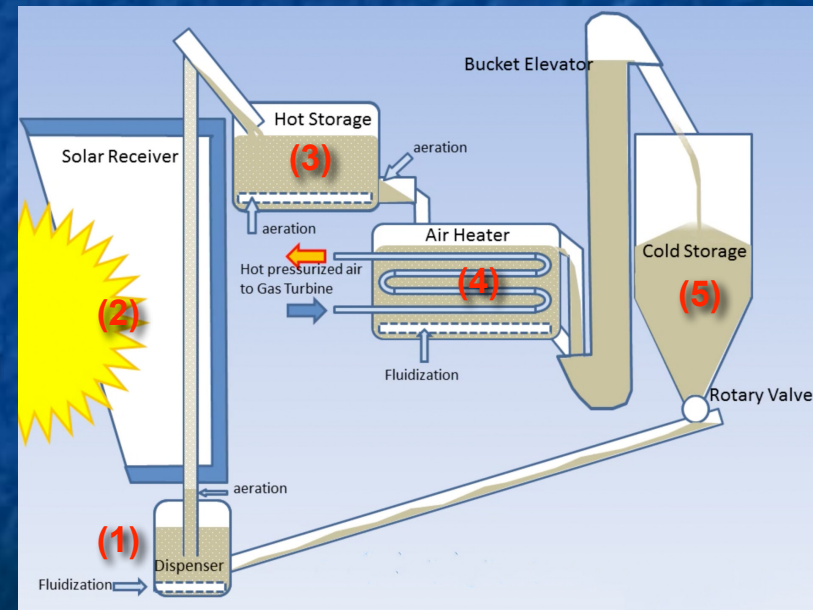

# How much might new HTF's & Receivers improve Tower performance?

Max Carnot Conversion Efficiency  $\sim \Delta \text{ Temperature} / (\text{Highest Temperature})$

$\sim [T_{\text{high}} - T_{\text{low}}] / T_{\text{high}}$  for "absolute" temperatures measured in °K

$T_{\text{low}}$  would probably not change much, remaining near 473 °K (200 °C)

$T_{\text{high}}$  in present day water & molten nitrate salt receivers is just under 873 °K (600 °C)

The Carnot theoretical efficiency limit is then  $\sim (400/873) \sim 46\%$

Versus Ivanpah's record **measured** Tower efficiency of  $\sim 29\%$

The new Heat Transfer Schemes & Receiver designs discussed above

mostly elevate  $T_{\text{high}}$  to somewhere in the range of 973-1023 °K (700-750 °C)

Giving a new Carnot theoretical efficiency limit of  $\sim (550/1023) \sim 54\%$

Ignoring the questionable absolute numbers and instead just comparing their ratio:

New efficiency limit / Present efficiency limit  $\sim 54\% / 46\% \sim$  **1.2 times larger**

# *Parabolic Troughs / Concentrators*

# Next lower in efficiency are Parabolic Trough Solar Thermal Plants

Which the US DOE depicts schematically and photographically as: <sup>1</sup>

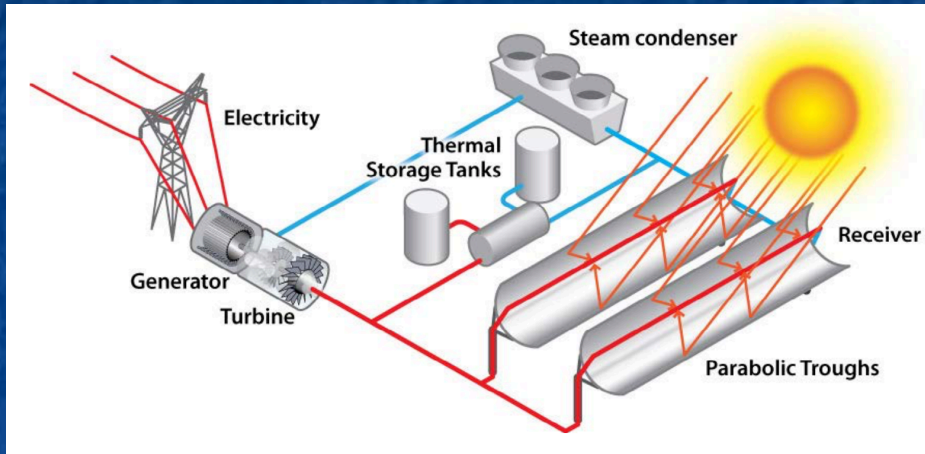

1) 2014 - The Year of Concentrating Solar Power - US DOE

Unlike continuous **Dish** paraboloids OR fragmented **Tower** paraboloids

**Parabolic Troughs** are just stretched out (extruded) versions of 2D parabolas

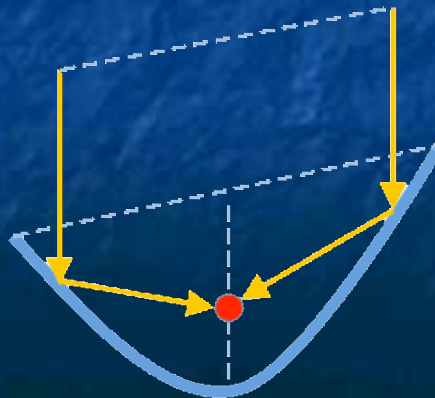

*Parabolic Troughs have a pipe-like Receiver running along their focal line*

In most installations a Heat Transfer Fluid is pumped along that Receiver

**Synthetic oils** are typical because they can withstand heating to  $\sim 390\text{ }^{\circ}\text{C}$

But experimental plants are exploring **molten nitrate salt** HTF's (stable to  $\sim 560\text{ }^{\circ}\text{C}$ ),

OR replacement of HTF's by **water** for high-pressure Direct-Steam-Generation <sup>1</sup>

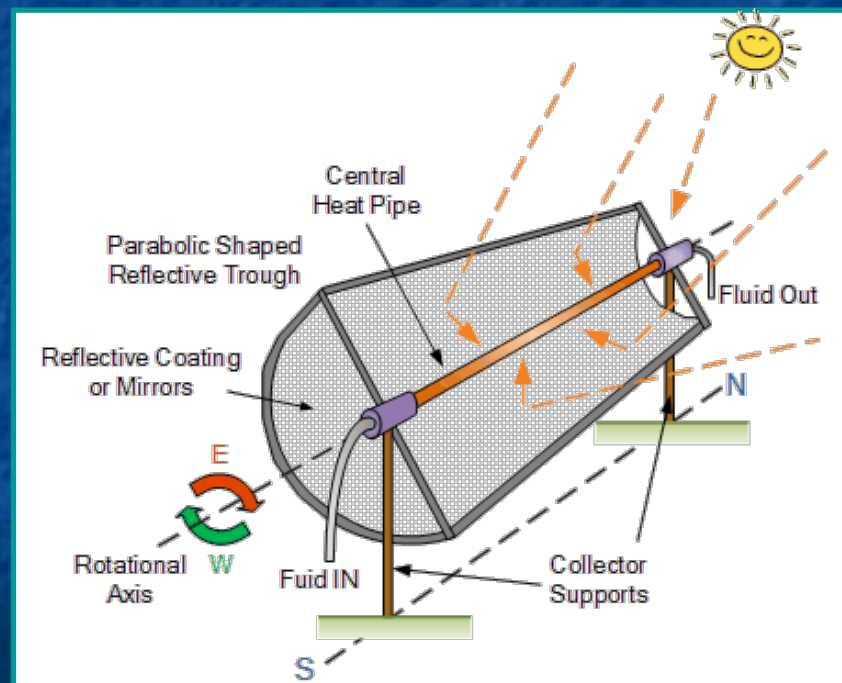

1) Concentrating Solar Power - Technology Brief, International Renewable Energy Agency - IRENA, 2013

Figure: <http://www.alternative-energy-tutorials.com/solar-hot-water/parabolic-trough-reflector.html>

*But high temperature and/or pressure again creates plumbing problems:*

Tower Central Receivers (above), with all of their necessary plumbing, **STAY PUT**

Leaving their multitude of tilting Heliostats to do the job of tracking the sun

But as with Dishes, Troughs themselves must do the tracking

And to maintain focus upon their Receiver, both must move together as a unit

Which resurrects the challenge of getting Heat Transfer Fluid OUT to do its transferring

Or the alternate challenge of getting extremely high pressure steam out

Use of high-temperature metal piping with rotating joints is again the only possibility,

but for Troughs (unlike Dishes) SINGLE tracking axis / rotation make that practical

*Rotating pipe joints at  
Parabolic Trough's ends*

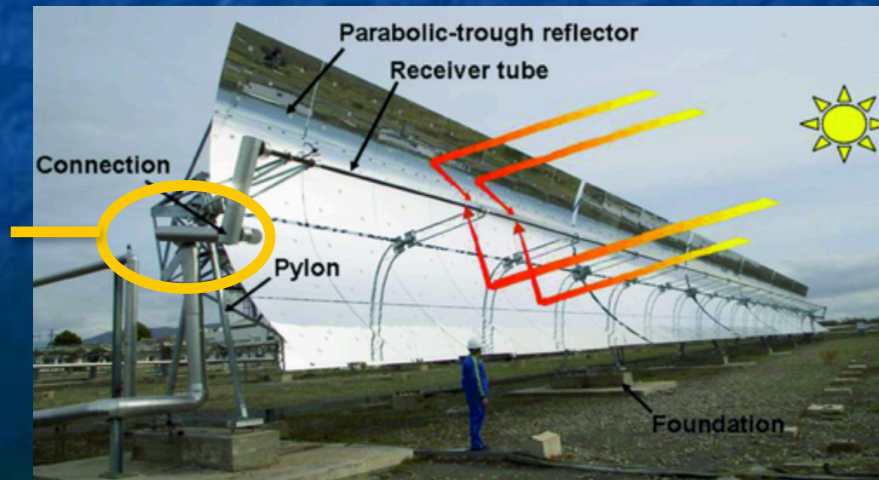

*Solar Thermal CSP  
Technology, M. Romero & J.  
Gonzalez-Aguilar, Wires -  
Energy and Environment  
3(1), pp. 42-59 (2013)*



## *The **length** of Parabolic Troughs ALSO demands single axis tracking*

These trough assemblies are typically at least 100 meters long <sup>1</sup>

So while rotating pipe joints can accommodate their side to side tilting

it is completely impractical to ALSO tilt them along their 100 meter length

But while the Sun moves East to West daily, it also shifts North to South seasonally



Should troughs run North-South to allow daily East to West sun tracking?

Or should they run East-West to allow seasonal North to South sun tracking?

That sounds like an almost dumb question because

the Sun's East-West motion is so MUCH MORE frequent and pronounced

*1) Concentrating Solar Power, Solar Energy Industries Association - SEIA*

*Which seemingly calls for North-South troughs tilting daily East to West*

But look again at my illustration of an East-West running trough (on the right)



Morning & evening sunlight would slant in from the ends of that East-West trough

But while parabolas focus perfectly only for light coming from directly above them,  
slanting sunlight would still bounce off a basically parabolic shape

which should still try to focus that light (albeit to points farther down that trough)

I concede that focus **would** be degraded and it **would** likely shift lower in the trough:

**Vertical incidence,  
Perfect focusing**

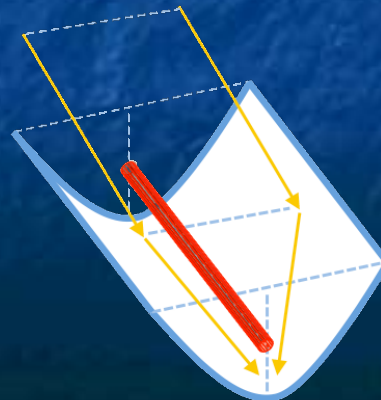
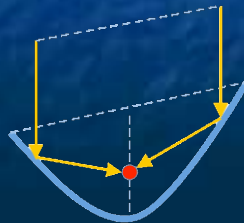

**Slanting incidence,  
Imperfect focusing**

## *So why accept degraded focus, slightly below the Receiver?*



Because such an East-West trough would NOT have to track the Sun second-by-second:

In the Northern Hemisphere, it would only have to be tilted mildly

Northward in the Summer, and Southward in the Winter

Which might only require shifting it (manually?) once in the Spring and once in the Fall

Not only would computerized second-by-second tracking become unnecessary,

but motors and potentially leaky rotating pipe joints might also be eliminated

by simply swapping in/out alternate fixed-angle pipe joints (a.k.a. "unions")

I dug into government, industry and academic analyses of parabolic trough focusing <sup>1</sup>

And could not find ANY study raising (much less analyzing) this long-shot possibility <sup>2</sup>

*1) For details see the Parabolic Trough papers papers cited on this note set's Resources webpage ([link](#))*

*2) This website is named WeCanFigureThisOut because WE CITIZENS NEED TO UNDERSTAND OUR ENERGY CHOICES!*

# Returning to the dominant N-S running Parabolic Trough technology:

For the now common choice of **synthetic oil heat transfer fluids**,

temperatures within the Receiver pipe cannot exceed 400 °C

These temperatures, which are at least ~ 200 °C cooler than in Tower Receivers, slashing black body radiative heat loss (varying as temperature to the 4th power)

What is left are conductive & convective heat loss (e.g., by movement of gas atoms)

Parabolic Trough Receivers thus center HTF pipes within evacuated glass tubes

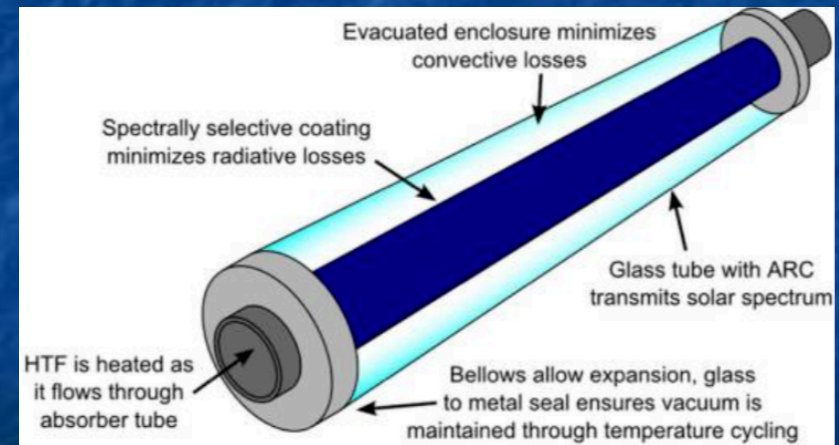
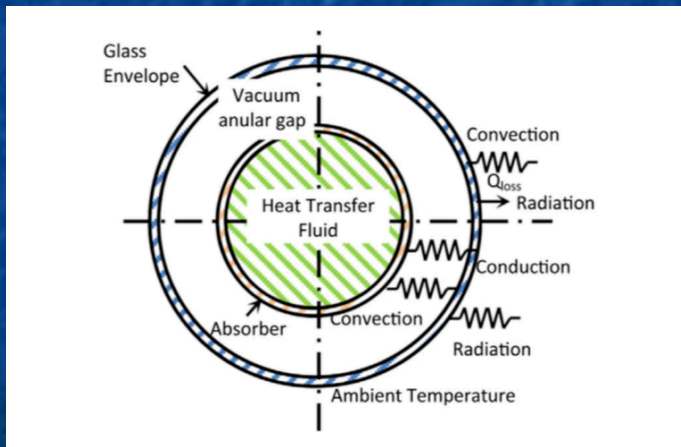

Left Figure: Review of Solar Parabolic Trough Collector Geometrical and Thermal Analyses, Performance, and Applications, Abdulhamed et al., Renewable and Sustainable Energy Reviews 91, pp. 822-31 (2018)

Right Figure: Concentrating Solar Power, Weinstein et al., Chemical Reviews 115, pp. 12797-12838 (2015)

## *Summarizing Today's Parabolic Trough Solar Thermal Power:*

Common Parabolic Trough configuration: N-S running, daily E-W tilting, oil HTF pumping

With single axis tracking, Parabolic Troughs concentrate sunlight by only **~ 100X**<sup>1</sup>

Versus Solar Tower / Heliostat field or Dish-Engine concentration ratios of **~ 1000X**

That produces Parabolic Trough Receiver temperatures of **~ 390 °C**

Versus Solar Towers' (fluid limited) **600 °C** or Dish-Engines' over **1000 °C**

Yielding Parabolic Trough solar to electrical power Conversion Efficiencies of **14-16%**<sup>2</sup>

Versus Solar Towers' **29%** or Dish-Engines' **29-32%**

Only molten salt Solar Towers now offer effective / extended heat energy storage

But for Parabolic Troughs, the Spanish Andasol & Valle I/II plants

ARE testing schemes for transferring oil HTF heat into molten salt reservoirs<sup>1</sup>

ALL of the above technologies now employ widely spaced mirrors / mirror assemblies  
to accommodate regular servicing & manual (non-automated) mirror washing

1) *Concentrating Solar Power*, Weinstein et al., *Chemical Reviews* 115, pp. 12797-12838 (2015)

2) *Concentrating Solar Power - Technology Brief*, International Renewable Energy Agency - IRENA, 2013

# *Linear Fresnel Reflectors / Concentrators*

# *Fresnel Linear Reflectors / Concentrators*

In 1823 the French scientist August Fresnel ("fray-NEL") demonstrated an immensely thinner, lighter and thus more practical lighthouse lens <sup>1</sup>

As embodied in Snell's Law of light refraction, he knew that light changes direction ONLY as it passes in or out of a material (and not while traveling through it):

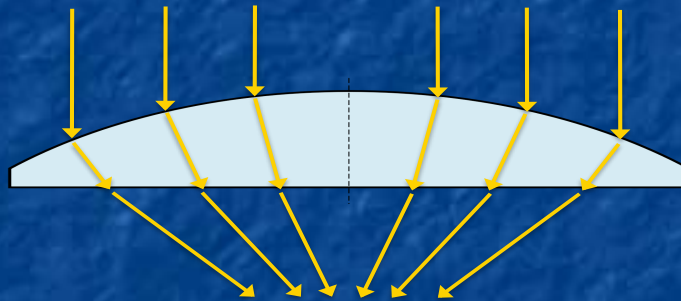

So he just did away with the useless inner volumes of a conventional focusing lens:

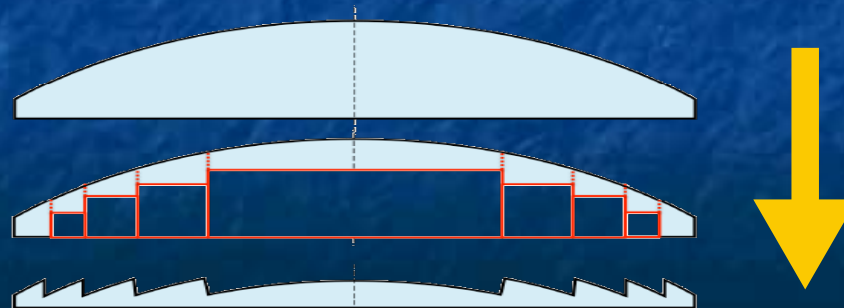

1) See, for example: [Wikipedia's Fresnel Lens webpage](#)

*Modern Linear Fresnel Reflectors do the same thing for parabolic mirrors:*

Which is equivalent to a Parabolic Trough cut into slivers and then flattened out:

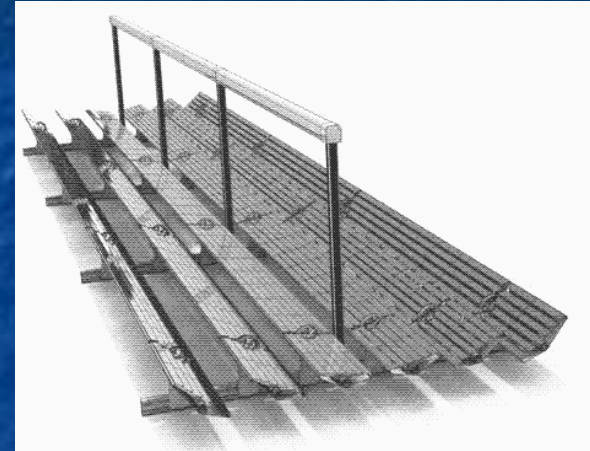
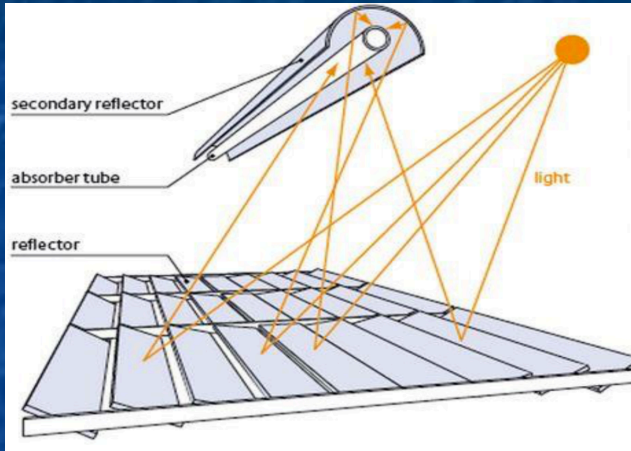

*Design and Analysis of Rooftop Linear Fresnel Reflector Solar Concentrator - Gouthamrai et al., Int J Eng. & Innovative Tech 2(11) pp. 66-69 (2013)*

<https://solar.lowtechmagazine.com/2011/07/solar-powered-factories.html>

Or to a single stripe of of Solar Tower Heliostat mirrors that have been stretched out

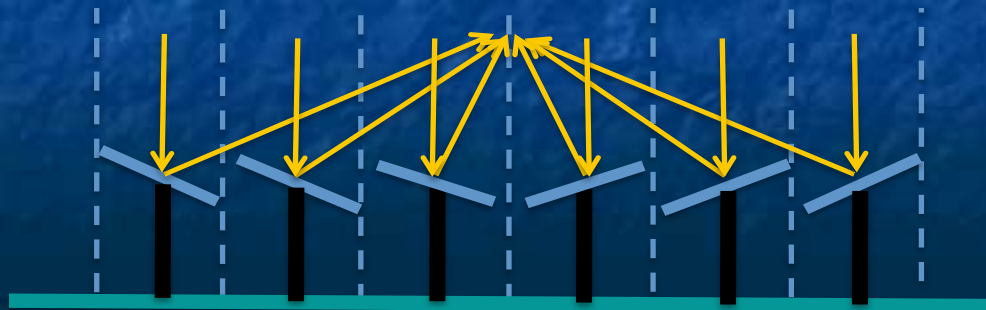



*The mirrors then tilt almost like common venetian window blinds*

But to direct sunlight up to a parallel Receiver, each mirror must tilt differently

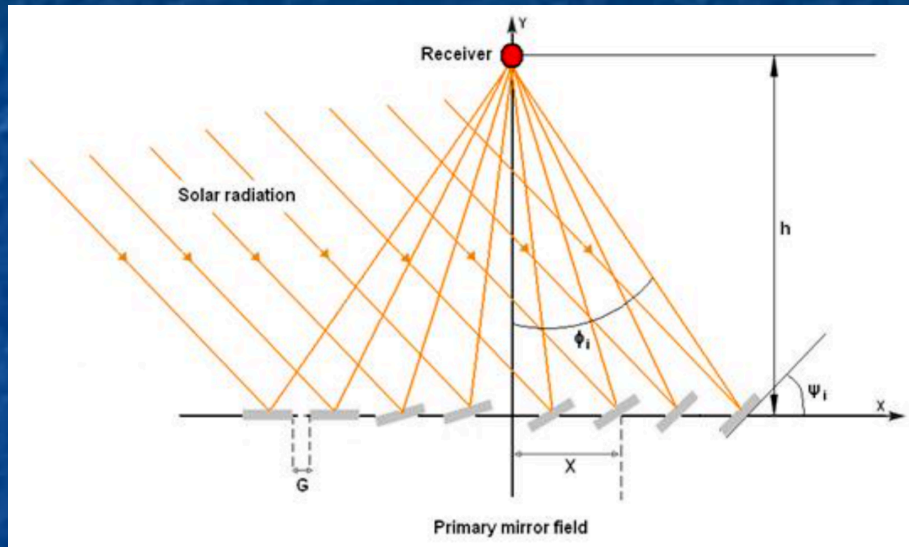

Despite appearances, **this is more like a Solar Tower than a Parabolic Trough**

Why? Because the Receiver, with its high-temperature and/or high-pressure plumbing,

is once again completely STATIONARY (vastly simplifying all of that plumbing),

with only the immensely simpler mirrors moving to track the sun

*Left Figure: Analytic Optical Design of a Linear Fresnel Solar Collector with Variable Parameters, Eddhibi et al., J Mat Env Sci 8 (10), pp. 4068-84 (2017)*

*Right Figure: Analytic Optical Design of a Linear Fresnel Solar Collector with Variable Parameters, Eddhibi et al., J Mat Env Sci 8 (10), pp. 4068-84 (2017)*

*And this arrangement comes with further advantages:*

First, as illustrated below, the mirrors can be laid out in densely packed stripes occupying 60-70% of the ground area (vs. 33% for Parabolic Troughs) <sup>1</sup>

Computers might then even dynamically select the **optimum grouping** of mirrors used to direct the moving sun's light to a particular parallel Receiver

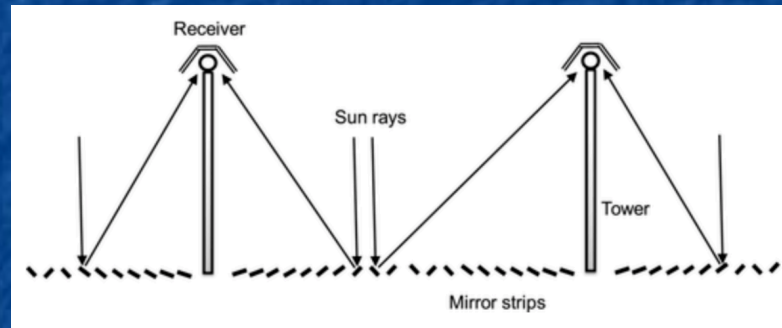

*1) Solar Thermal CSP Technology, M. Romero & J. Gonzalez-Aguilar, Wires - Energy and Environment 3(1), pp. 42-59 (2013)*

Second, with the mirrors in an almost flat single plane that is very close to the ground, those mirrors are much less susceptible to desert windstorms that can damage far taller / wind-catching Dishes, Heliostats & Parabolic Troughs

Finally, because mirrors ARE nicely parallel & close to the ground, this is the **ONLY** Solar Thermal technology using simple robotic machines to clean its mirrors

## *But there are certain disadvantages:*

Discontinuous parabolic Linear Fresnel mirrors do not focus light

quite as effectively as the continuous parabolic mirrors of Parabolic Troughs

They thus employ wider receivers to collect that less well focused light

Those Receivers contain multiple side-by-side Heat Transfer Fluid pipes

plus trapezoidal backside reflectors to trap any light missing those tubes

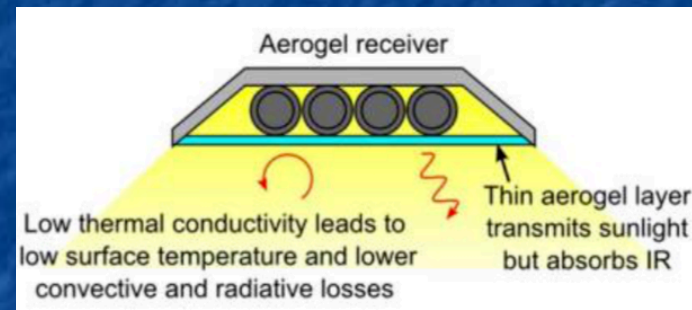
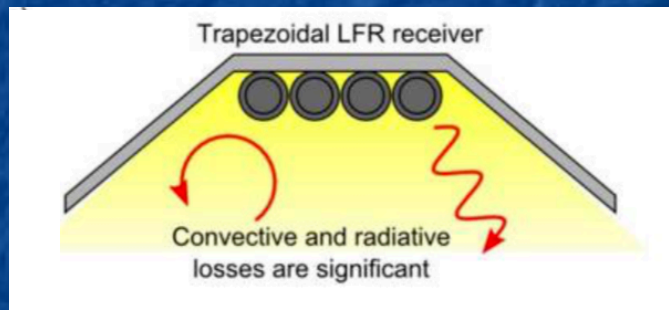

Those Receivers still reach lower temperatures than those of Parabolic Troughs

But their convective heat-loss IS then reduced to the point that their collection tubes don't have to be enclosed within costly & delicate evacuated glass enclosures

# A comparison of all four mainstream Solar Thermal technologies: 1, 2

	<b>Dishes</b>	<b>Solar Towers</b>	<b>Parabolic Troughs</b>	<b>Linear Fresnel</b>
Typical Configuration:	Dish arrays	Center or Side	N-S Trough Arrays	Dense N-S arrays
Receiver:	Stirling Engine with Generator	Cavity or non-cavity	Linear / Evacuated	Linear Direct-to-Steam
Concentration Ratio:	~ 1000 X	~ 1000 X	~ 100 X	~ 80 X
Receiver Temp:	Up to 1200 °C	Up to 575 °C	400 °C	300-400 °C
Receiver Fluid(s):	Pressurized Gas	Water or Salt	Oil (eventually Salt?)	Water
Conversion Efficiency:	29-32%	Up to 29%	~14-16%	~13%
Heat Storage:	None	10 (or more?) hours	Not yet (eventually?)	None
Plusses & Minuses:	Exotic components Poor land use Wind susceptibility Manual cleaning	Wind susceptibility Manual cleaning Water use Bird kills	Mature technology Wind susceptibility Manual cleaning Water Use	Effective land use Lower costs Robotic cleaning Water use

1) Table data are from sources cited earlier, or publications identified in this note set's Resources webpage ([link](#))

2) Trends exhibited in this table are consistent within those sources, but numerical values often differ significantly. Industry associated sources tend to cite more positive data. While their bias may of course be a factor, I've found that industry sources are often much better informed about forefront technology than governmental and academic sources.

## *Yielding these patterns of current Solar Thermal deployment:*

Number of U.S. Solar Thermal plants by type (not accounting for power outputs): <sup>1</sup>

Dish-Engine: 2   Solar Tower: 36   Parabolic Trough: 99   Linear Fresnel: 14

Versus International Renewable Energy Agency (IRENA) statement that (in 2013) <sup>2</sup>

90% of worldwide Solar Thermal power was produced by Parabolic Troughs

(a breakdown of the other 10% of Solar Thermal power was not provided)

And this International Energy Agency (IEA) figure about worldwide Solar Thermal: <sup>3</sup>

**Line** = Total worldwide Solar Thermal Power

(left axis)

**Colored bars** = Solar Thermal Power ADDED

within that region within that year

(right axis)

Line's fall also implies recent plant CLOSURES

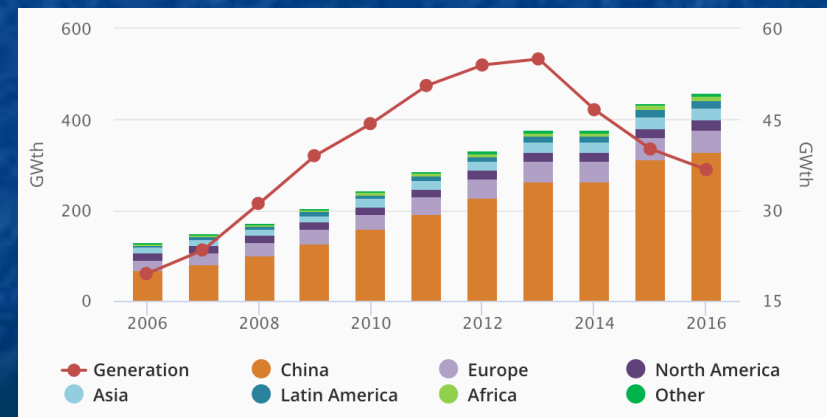

1) <https://solarpaces.nrel.gov/>

2) <https://www.irena.org/publications/2015/Oct/Concentrated-Solar-Power>

3) <https://www.iea.org/topics/renewables/solar/>

# And this comparison of Solar Thermal Power cost by technology:

As reported in a talk by Prof. Nick Jelley (Physics Department, University of Oxford) <sup>1</sup>

with his source cited as "SBC Energy Institute Solar Factbook 2013"

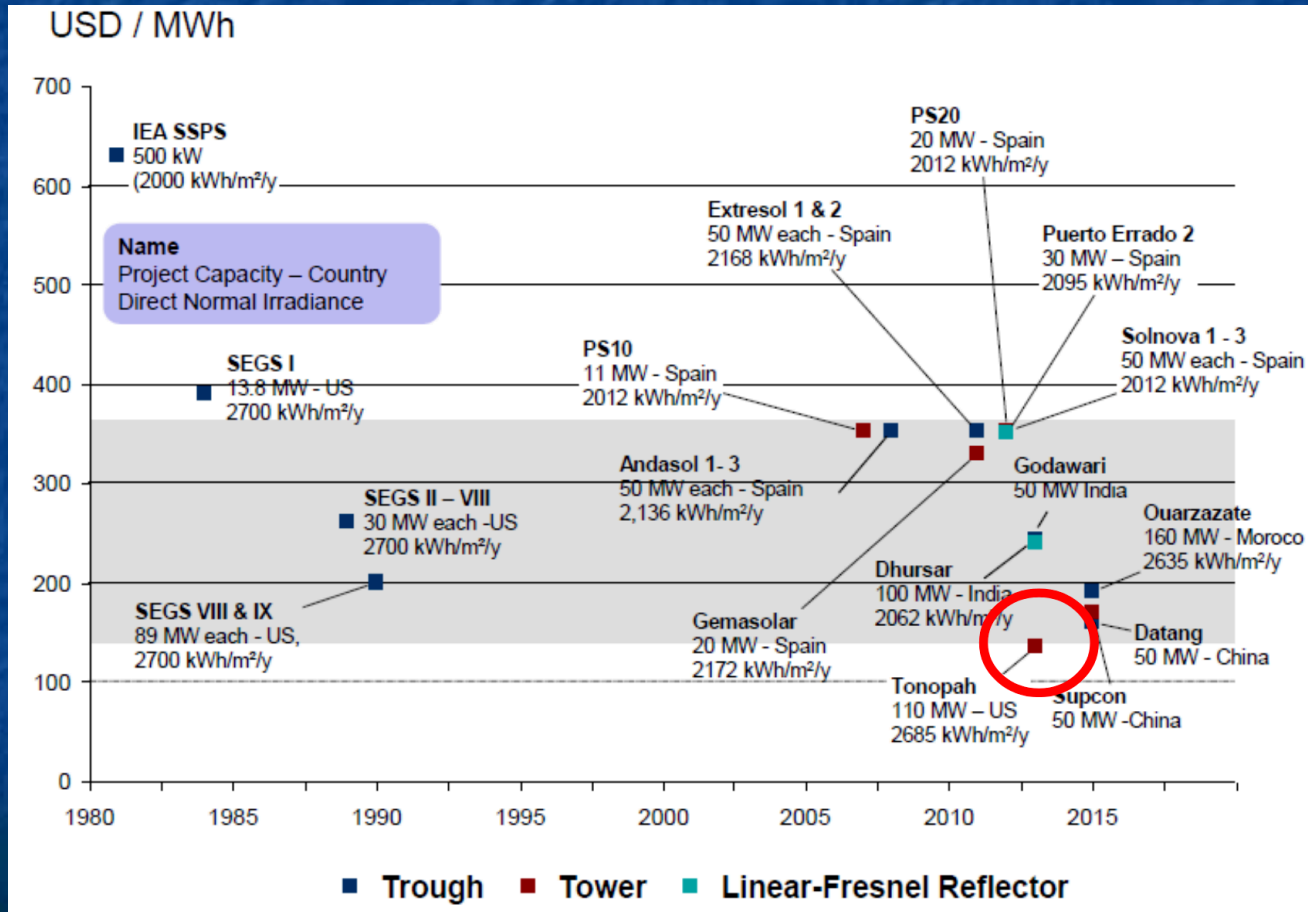

1) Concentrated Solar Power and Thermal Storage, Prof. Nick Jelley, Physics Dept., University of Oxford  
(Link & cached copy of his talk are provided on this note set's Resources webpage ([link](#)))

# *Heat Storage*

# *Heat Storage*

I have identified Crescent Dune's molten salt storage as a "Potential Breakthrough"

One that might :

Provide the first true 24/7 Green Energy Source

End Solar Thermal's "Non-green marriage-of-convenience with Natural Gas"

Eliminate "One of the two biggest hurdles to building a Green Grid"

A full explanation is complicated and, at a minimum, calls strongly upon my note sets:

U.S. Energy Production and Consumption ([pptx](#) / [pdf](#) / [key](#))

A Generic Power Plant and Grid ([pptx](#) / [pdf](#) / [key](#))

Fossil Fuels Power Plants ([pptx](#) / [pdf](#) / [key](#))

As well as technology-specific note sets about Hydro, Wind, Photovoltaic & Nuclear Power

AND note sets about the Smart Grid and existing forms of Energy Storage



*But let me here try for a (radically) abbreviated explanation:*

You might guess that our consumption of power peaks during the day

It doesn't - A very pronounced peak instead occurs in the evening:

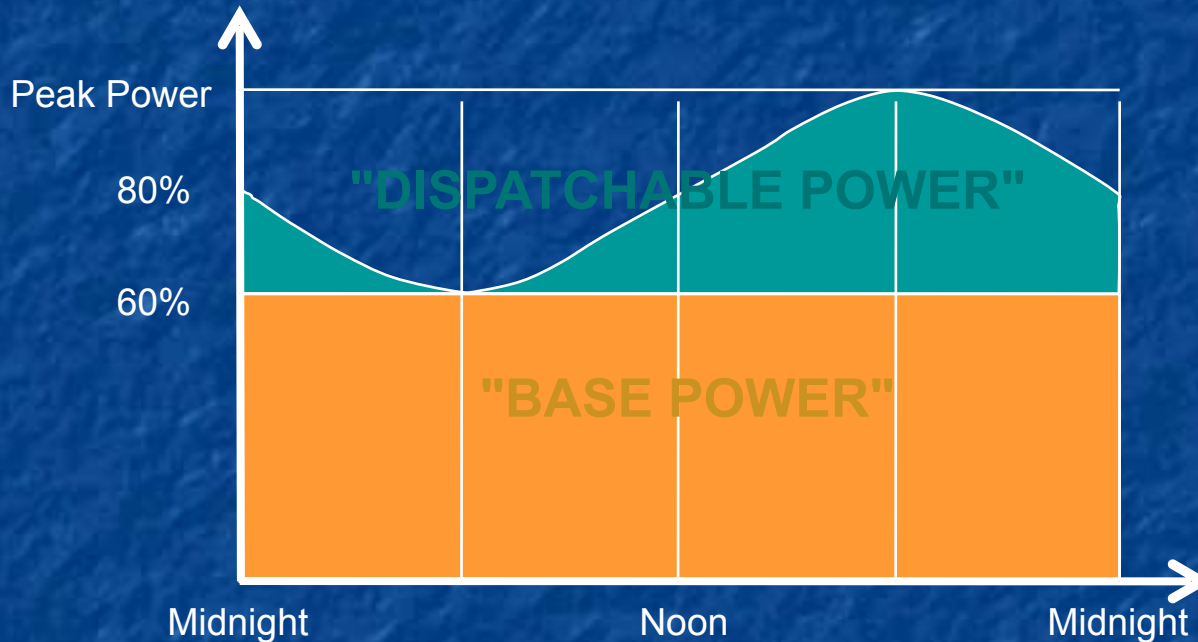

Power companies divide this Power Demand into two segments,

which are referred to as **"Base Power"** and **"Dispatchable Power"**

They do this because each requires **different types of power plants**

## *Water-boiling steam turbine power plants provide Base power*

This includes coal, oil and some natural gas plants, as well as nuclear power plants

These generally massive plants use a massive amount of heat to boil that water

Indeed, from a cold start they need many hours to get up to full operating temperature

Which, to improve the plant's efficiency, is generally **well above 100 °C**

Being as massive as they are, requiring so much energy to even **start** operating:

You do **NOT** want to turn such plants **on and off**

You do **NOT** even want to turn their power levels **up or down** very much

Which is why they are used as **BASE** (i.e., essentially constant) power sources

**DISPATCHABLE** (i.e., adjustable) power plants then power up in the evenings

But used for as little as a half dozen hours a day,

power companies benefit far less from the money invested in such plants

If allowed, power companies will thus charge far more for evening power

**And they will certainly try to use plants that are cheaper to build or buy**

## *The U.S. Dispatchable favorite is one type of Gas Turbine Plant:*

It is basically a jet engine burning Natural Gas (rather than kerosene),  
which is connected directly (and simply) to an electrical generator,  
but which **wastes heat** in its very hot exhaust by sending it up a chimney

Giving it the name: **Open Cycle Gas Turbine (OCGT)**

As shown here schematically:

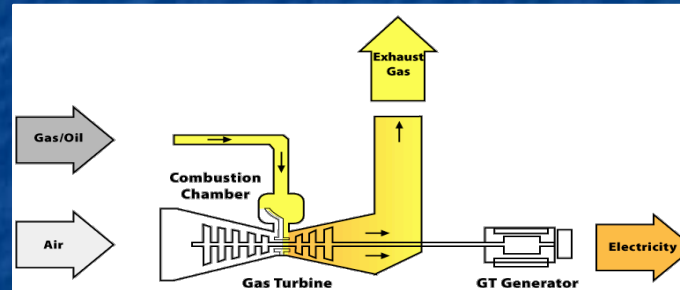

Or here pictorially (this is essentially the entire "power plant," all ~ 25 meters of it!)

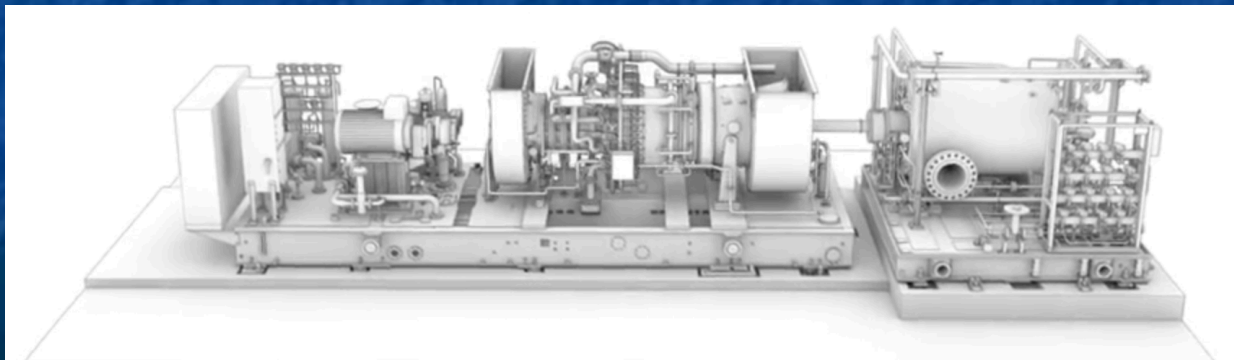

Top: <https://www.consumersenergy.com/content.aspx?id=1345>

Bottom: <https://www.youtube.com/watch?v=OkfqUSBdN8M>

*To these established power sources we now want to add Sun and Wind:*

Solar power of course peaks midday

While in most onshore locations Wind velocity peaks late afternoon, and because wind power scales as **velocity cubed**, its power peak is even sharper:

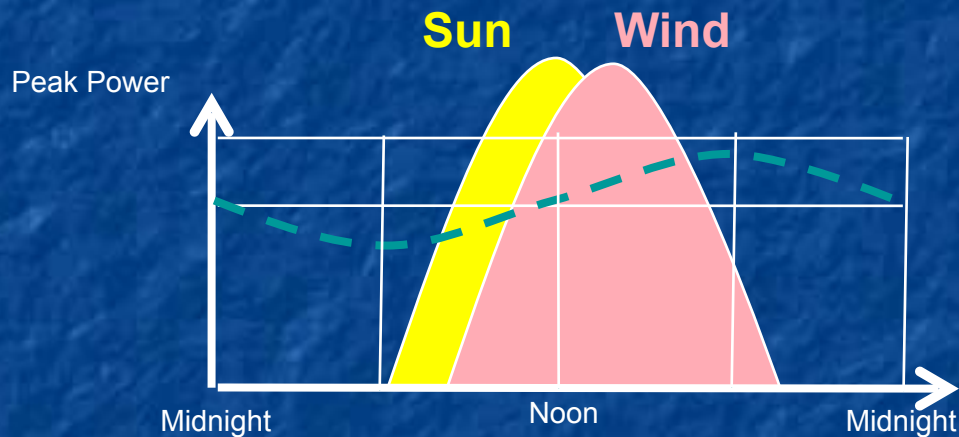

Comparing this to the earlier (status quo) BASE / DISPATCHABLE figure,

it is clear that this is **not WHEN we need more power**

It might be used to reduce the Base Power level

But evening & night, you'd just end up needing more Dispatchable power

*That makes little economic (or environmental) sense*

Further, as a Grid struggles to absorb more than about 20% daylight green power  
it can actually become unstable and more prone to blackouts

The obvious solution is to store daylight wind & solar power for later evening use

But existing Grid power storage technologies are so expensive that

their use would effectively **double the cost of wind & solar power** <sup>1</sup>

That's why **Solar Thermal + Heat Storage** represents a breakthrough

That heat storage is not a separate expensive technology

Piping around heat, ALL Solar Thermal Plants use at least brief heat storage

**With the right Heat Transfer Fluids paired with the right Concentrators,**

**all you need is MORE of that Heat Transfer Fluid**

**and a well-insulated place to store it for a fraction of the day**

1) See data near the end of my note set: *Power Plant Economics* ([pptx](#) / [pdf](#) / [key](#))

## *"Places" that look like this:*

Molten salt storage tanks incorporated into

Arizona's Solana Plant (left) and Spain's Andasol Plants (right):



*Left: DOE's "2014 - The Year of Concentrating Solar Power"*

*Right: Solar Thermal CSP Technology, M. Romero & J. Gonzalez-Aguilar, Wires - Energy and Environment 3(1), pp. 42-59 (2013)*

## *What about the "Non-green marriage-of-convenience with Natural Gas?"*

There I was referring to today's Solar Thermal in the absence of Heat Storage

As I noted above, the world's biggest Solar Thermal Plant (Ivanpah),

along with other plants, must now burn natural gas every morning

to re-heat their water to the point that sunlight can begin to boil it

Which obviously adds to Solar Thermal's already very high cost

AND disqualifies it as a green (non-greenhouse gas producing) technology

Power companies recognized (at least one) of these shortcomings and came up

with something making economic (and perhaps limited environmental) sense

Their solution goes back to those **Open Cycle Gas Turbines**

And the heat they now wastefully send right up their exhaust chimneys

## *Burning Natural Gas gets hotter AND expands:*

**Open Cycle Gas Turbines** are driven by that expansion but send heat up a chimney

Another type of Natural Gas power plant ALSO exploits that heat - It's thus called a

**Combined Cycle Gas Turbine (CCGT)** which uses **two turbine-generators**:

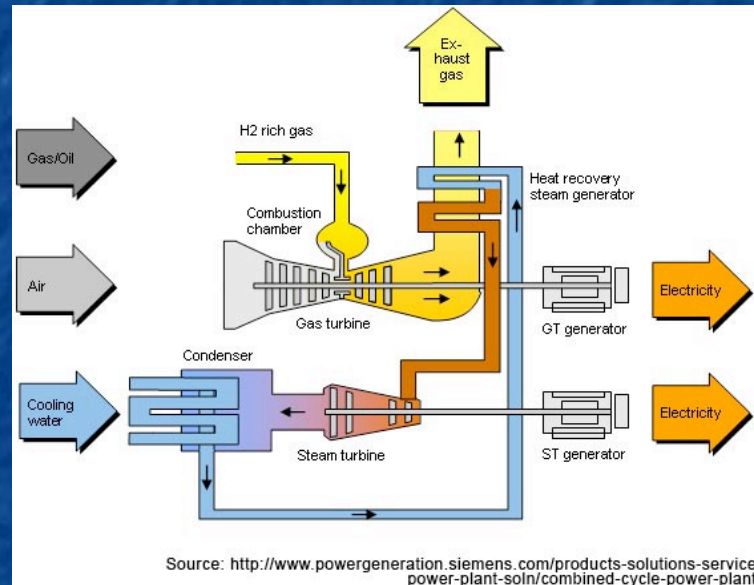

Water pipes run in/around the hot exhaust of the **gas turbine-generator** (top / yellow)

The exhaust's heat boils that water, expanding it by about 1700 times,

and that steam then drives a **steam turbine-generator** (lower / blue)



*But Solar Thermal Plants ALREADY have a **steam turbine-generator***

Which, by morning, is desperately seeking heat to boil its water

So rather than just burning natural gas (exploiting only the heat produced) :

Feed that natural gas into a **gas turbine-generator**

Then use its exhaust to heat the Solar Thermal plant's water

This sends out gas-turbine power, while kick-starting the Solar Thermal plant

Which, in fading afternoon sunlight, or under drifting clouds

might again benefit from supplemental gas-turbine generator heat

This sort of symbiotic arrangement is now being exploited in what is effectively a

**Combined Cycle Gas + Solar Turbine power plant** (CCG&ST or CCG/ST?)

IT is the "marriage-of-convenience" to which I was alluding

*Heat Storage could eliminate the attraction of such a marriage*

Transforming Solar Thermal into arguably our first "24/7 Green Energy Source"

Although that is a claim that Hydroelectric Power could legitimately dispute

Such a 24/7 Green Energy Source (in concert with Hydro) **could** remove

one of two key hurdles to creating a green and hopefully sustainable Grid

The other key hurdle?

Getting that green power to WHERE we most want to use it

Which, at least for now, is in our urban and/or coastal regions

Solar Thermal's high desert locations will certainly **NOT** help with that hurdle

Which instead calls for much more effective long distance power transmission

for which today's best option is Very High Voltage DC Power lines <sup>1</sup>

(from which Wind, Solar and Hydro power would also benefit)

1) See my note set: [A Generic Power Plant and Grid \(pptx / pdf / key\)](#)

# *Water Usage*

What is the shortcoming seen in all of these DOE illustrations?

### Solar Tower Plant

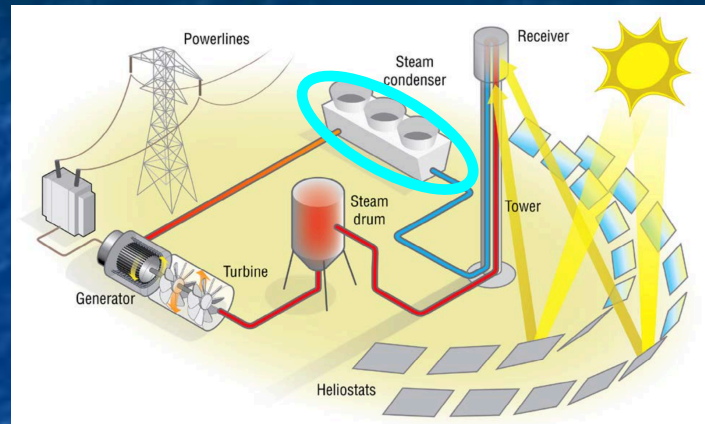

### Parabolic Trough Plant

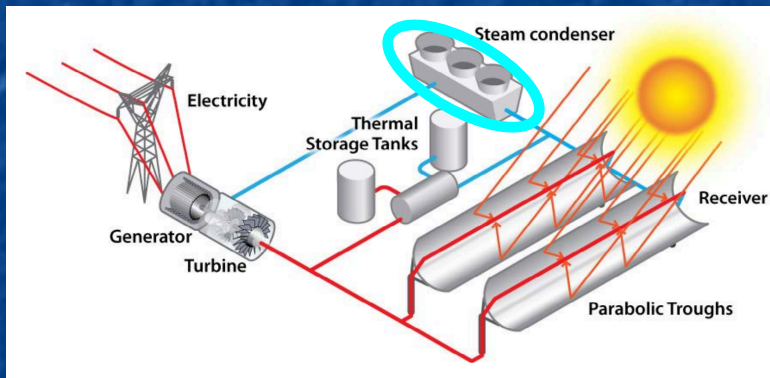

### Linear Fresnel Reflector Plant

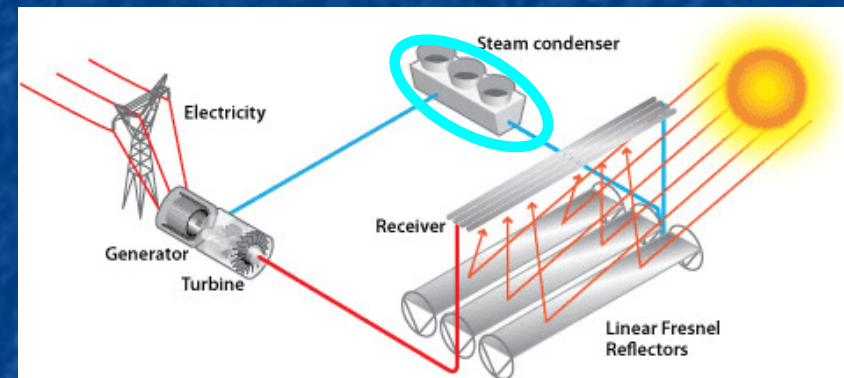

**The answer: Water-driven Steam Condensers**

Top & Bottom Left: 2014 - The Year of Concentrating Solar Power - US DOE

<http://www.energy.gov/eere/sunshot/downloads/2014-concentrating-solar-power-report>

Bottom Right: <https://www.energy.gov/eere/solar/articles/linear-concentrator-system-basics-concentrating-solar-power>

*After heat expands water into the steam turning turbine-generators . . .*

That steam needs to be cooled back into liquid so that it can repeat the cycle

This occurs within **Heat-Exchangers** fed by water from **Cooling Towers**

Within **Evaporative** cooling towers, sprays of hot water fall through a honeycomb

Some cooling comes from air pulled upward through the honeycomb by a fan

Some cooling comes from evaporation of part of that water

**But evaporating water is "lost" and must be continuously "made up"**

<http://www.matrixcooling.com/cooling-towers/counterflow-cooling-towers/>

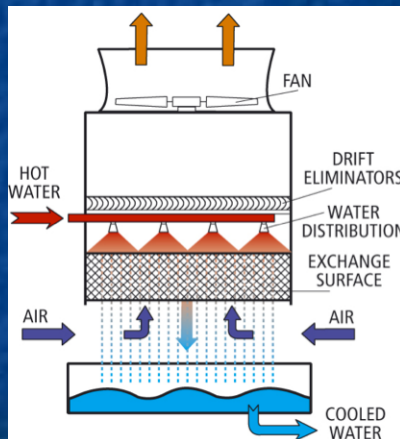

<http://poongcheon-group.com/web/en/frame/news/id/80/induced-draft-open-circuit-counter-flow-cooling-tower.html>

**A now little-used alternative (because of its lower effectiveness / increased cost):**

**PIPE water past the air flow, eliminating its evaporation = "Dry-Cooling"**

# Additional water is used for regular cleaning of the mirrors

Of which there are **347,000** within Ivanpah's three heliostat fields (!) <sup>1</sup>

## How much total water is used, and how is it used?

At an industry workshop, Dr. Raymond Branke of Germany's Fraunhofer Institute analyzed water use for a possible Parabolic Trough plant near Las Vegas,

based on cooling tower type, with & without **thermal energy storage (TES)** <sup>2</sup>

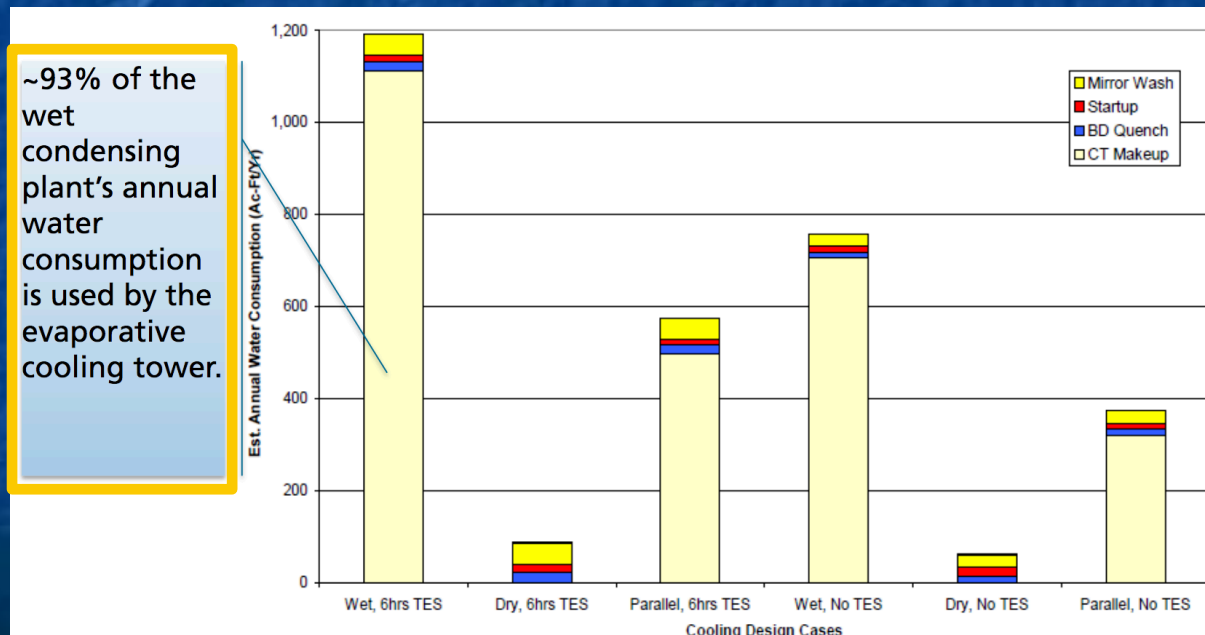

1) Ivanpah Solar Power Facility - Wikipedia

2) Figure from Dr. Branke's talk (yellow box added): <http://helioscsp.com/water-use-in-concentrated-solar-power-plants/>

He then compared that plant's water consumption to the water used by all sorts of **other** power plants

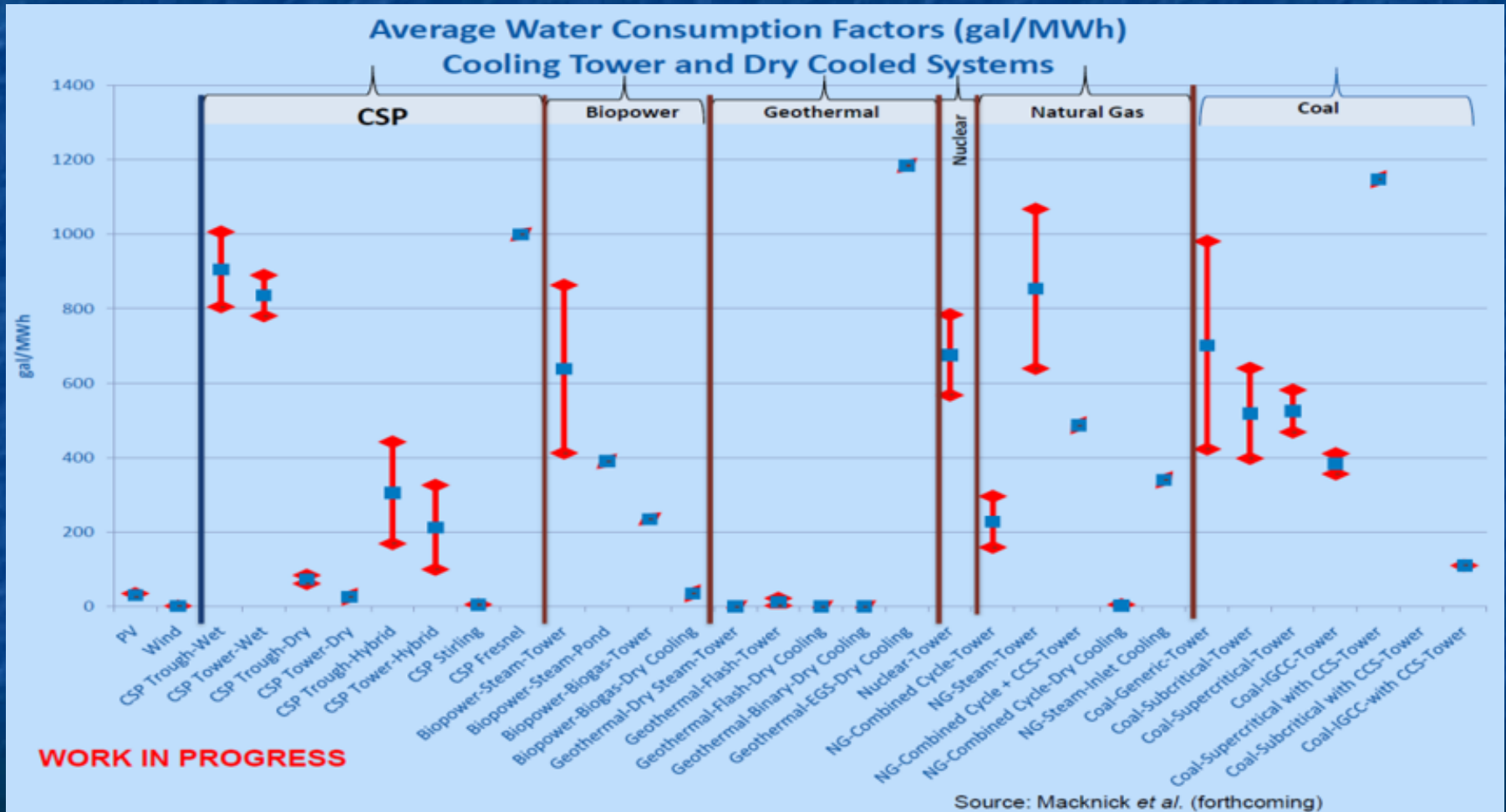

*On the left are his estimates for various Solar Thermal technologies*

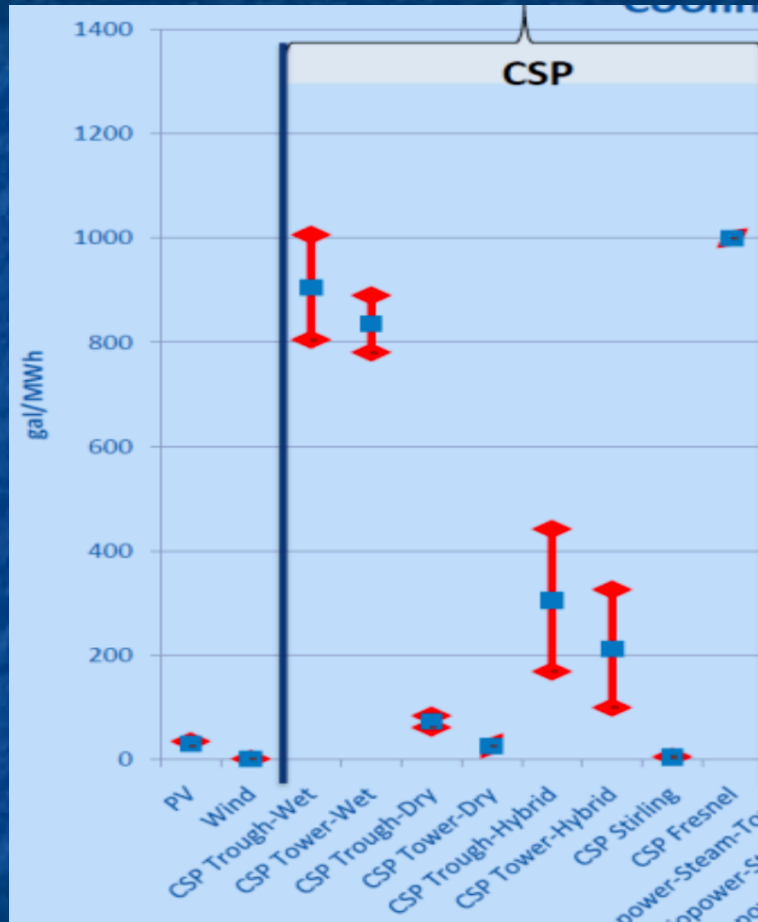

Squinting to read off gallons of water use per MW-hr of electrical energy generated:

Troughs / evaporative cooling: **900 gal / MW-hr**

Towers / evaporative cooling: **840 gal / MW-hr**

Troughs / hybrid cooling: **300 gal / MW-hr**

Towers / hybrid cooling: **200 gal / MW-hr**

Troughs / dry cooling: **40 gal / MW-hr**

Towers / dry cooling: **20 gal / MW-hr**

Dish-Stirling: **~ 0 gal / MW-hr**

Fresnel Reflector: **1000 gal / MW-hr**

*WHY are Fresnel Reflectors right off the map?*

*It must involve their now increasingly unique use of Direct-Steam-Generation*



## What is the "hybrid" cooling to which Branke's figure refers?

Its cooling is still provided by a combination of passing air AND partial water evaporation

But each is separately engineered & optimized

within a different section of the cooling tower (as seen in the figure below) <sup>1</sup>

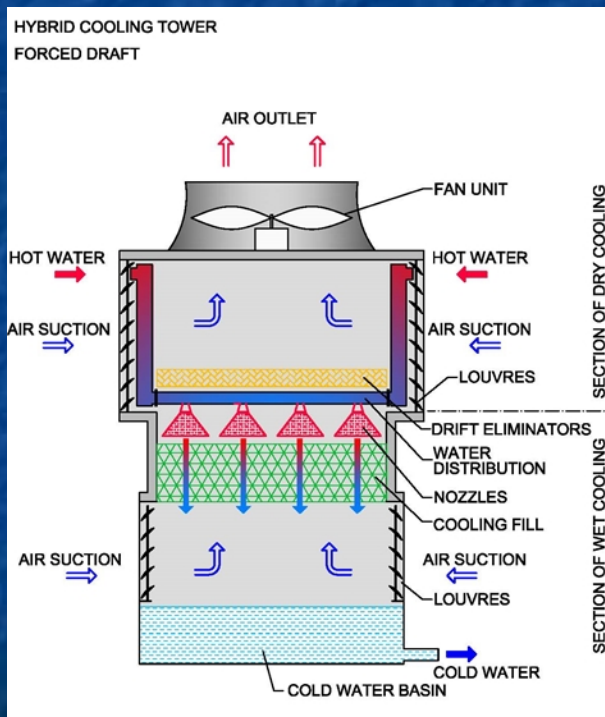

## How much cost would FULLY Dry Cooling add?

Branke predicted a 2.5-9% rise in present day Solar Thermal Power cost (depending on plant's climate)

## But what cooling do such "present day" plants use?

67% of the world's plants now use Wet Cooling

Only one (Crescent Dunes) uses Hybrid Cooling

And he cited NO plant using Dry Cooling

(as of the February 2018 date of his talk)

*But might fully deployed Solar Thermal consume only a "drop" from the Southwest's shrinking water bucket?*

## **I found two in-depth studies addressing that question**

From a U.S. Congressional Research Service study (summary): <sup>1</sup>

"The quantity of electricity produced at these facilities, the water intensity per unit of electricity generated, and the local and regional constraints on **freshwater will shape the cumulative effect of CSP deployment on southwestern water resources and the long-term sustainability of CSP as a renewable energy technology.**"

As echoed in a later U.S. National Renewable Energy Lab financed study (page 44): <sup>2</sup>

"CSP plants require significant amounts of space and ample sunshine, which often means that the most suitable locations are in remote, desert areas far from large population centers. The siting of these projects in such areas typically makes connecting to municipal, industrial, or wastewater supplies prohibitively expensive, which typically leaves groundwater as the only feasible water supply for such projects. However, **given increasing demands for freshwater supplies in the Southwest, acquiring the right to use groundwater or other water sources for CSP plants, especially for cooling purposes, can be an expensive, time-consuming, and sometimes contentious process that has the potential to significantly delay or even scuttle projects.**"

*Links and cached copies of the following are provided on this note set's Resources webpage ([link](#)):*

*2) Water Issues of Concentrating Solar Power (CSP) Electricity in the U.S. Southwest, N.T. Carter & R.J. Campbell, Congressional Research Service 2009*

*1) Concentrating Solar Power and Water Issues in the US Southwest, Bracken et al., Joint Inst. for Strategic Energy Analysis & NREL, 2015*

*Given the strength of those statements . . .*

And given Solar Thermal's present huge dependence upon government subsidies

With the public goodwill / lack of moneyed opposition such subsidies require

**I was VERY surprised at the Solar Thermal industry's apparent tone deafness,**

as suggested by Branke's claims that (in 2018):

Only ONE Solar Thermal plant was using water-conserving **hybrid cooling**

And his inability to identify ANY plant using **dry cooling**

But the NREL commissioned report cited above DOES suggest that

water conservation is **finally** on the Solar Thermal industry's radar (page vii):

**"Of the 24 CSP plants that are operational in the Southwest, 17 are wet-cooled.**

**In contrast, of the 15 CSP projects that are under construction or development in the region, at least 9 will be dry-cooled, hybrid-cooled, or use reclaimed water. "**

# *Bird Kills*

## *Bird kills due to Solar Thermal Power plants:*

**"No-fly zone: California solar thermal farm proves fatal to birds" <sup>1</sup>**

**"Why solar-thermal farms are accurately called wing-toasters" <sup>2</sup>**

**"New solar power plant is actually a death ray that's  
incinerating birds mid-flight" <sup>3</sup>**

Those headlines all concerned the opening of the **Ivanpah Solar Tower Plant** in 2013:



Photo:  
[https://](https://www.marketwatch.com/story/could-californias-massive-ivanpah-solar-power-plant-be-forced-to-go-dark-2016-03-16)

[www.marketwatch.com/  
story/could-californias-  
massive-ivanpah-solar-  
power-plant-be-forced-  
to-go-dark-2016-03-16](https://www.marketwatch.com/story/could-californias-massive-ivanpah-solar-power-plant-be-forced-to-go-dark-2016-03-16)

1) No-fly zone: California solar thermal farm proves fatal to birds: [pv-magazine](http://pv-magazine.com)

2) <http://outrunchange.com/2015/06/16/why-solar-thermal-farms-are-acc...-called-wing-toasters-ivahpah-offs-an-estimated-3500-birds-a-year/>

3) <http://www.extremetech.com/extreme/188328-californias-new-solar-power-plant-is-actually-a-death-ray-thats-incinerating-birds-mid-flight>

*But it took quite a bit of Googling to actually dig up hard numbers:*

The "toaster" article claimed that Ivanpah toasts about 3500 birds/year

A number it attributed to the blog site "Outrun Change" <sup>1</sup>

Which cited the Los Angeles Public Broadcasting TV station (KCET) <sup>2</sup>

Which quoted a number of 2500-6700 kills

A number it attributed to a study by "H.T. Harvey & Associates"

Which I was **finally** able to fully identify

***WHY are so many energy reporters & bloggers content with hearsay (a.k.a. gossip)?***

That source (which ONLY the reporters at KCET probably ever read) turned out to be:

***The Ivanpah Solar Electric Generating System Avian & Bat Monitoring Plan*** <sup>3</sup>

Which (commissioned by Ivanpah) was submitted to the California Energy Commission

1) <http://outrunchange.com/2015/06/16/why-solar-thermal-farms-are-accurately-called-wing-toasters-ivahpah-offs-an-estimated-3500-birds-a-year/>

2) <http://www.kcet.org/news/redefine/rewire/solar/solar-plant-likely-killed-3500-birds-in-first-year.html>

3) [http://docketpublic.energy.ca.gov/PublicDocuments/07-AFC-05C/TN204258\\_20150420T145549\\_Ivanpah\\_Solar\\_Electric\\_Generating\\_System\\_Avian\\_\\_Bat\\_Monitoring.pdf](http://docketpublic.energy.ca.gov/PublicDocuments/07-AFC-05C/TN204258_20150420T145549_Ivanpah_Solar_Electric_Generating_System_Avian__Bat_Monitoring.pdf)

## *That Ivanpah monitoring plan reported:*

Data for one year (four seasons), October 2013 – October 2014, including:

"Avian point counts, raptor/large bird surveys  
and facility monitoring for avian and bat fatalities"

Deaths of 54 bird species were noted, with diversity increasing in the spring & fall

Along with deaths of 9 raptor species and 6 other larger bird species

The surveys covered 100% of the 154 acres closest to the central tower

Plus 24% of the 720 acres occupied by more remote mirrors

Overall, 29.2% of the complete facility area was monitored

The result of this monitoring:

"A total of 32 bat detections, 695 avian detections (including 25 injured birds that died), and eight injured bird detections were found over the first four seasons"

# Centrally concentrated sunlight produced Centrally concentrated bird kills:

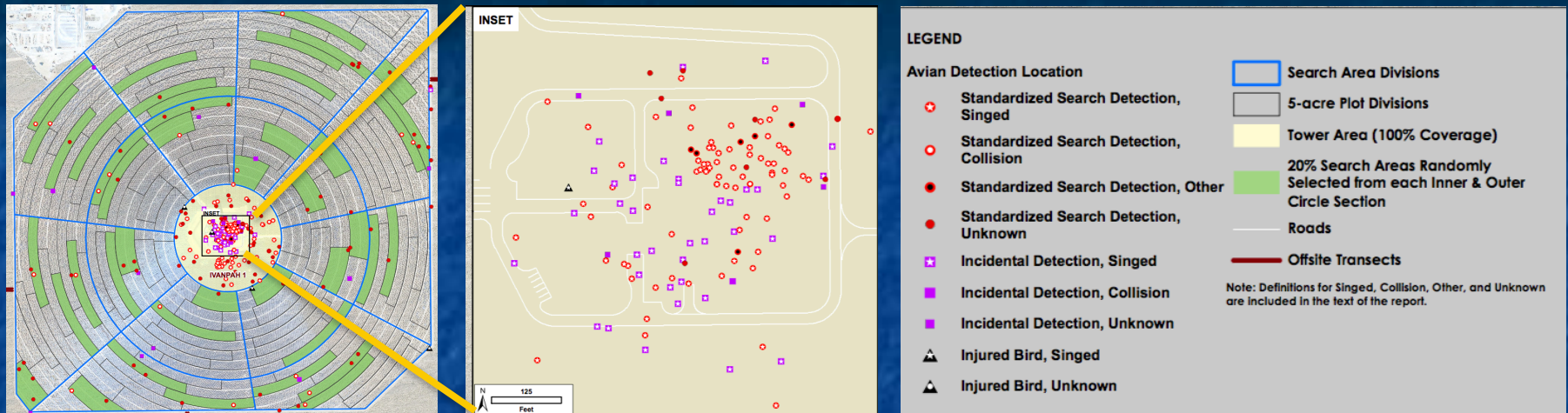

*From: The Ivanpah Solar Electric Generating System Avian & Bat Monitoring Plan*

Fatalities were 25.4 / acre near the central power block,

falling to 2.0 / acre in the inner rings of mirrors (i.e., heliostats),

falling to 0.3 / acre in the outer rings of mirrors

Causes of death were identified in 42.6% of cases

Of the identified causes, **47.4% were burns vs. 51.9% were collisions**

At a 90% statistical confidence level, the **full site bird kill extrapolations** were:

**1492 due to identified causes + 2012 due to unidentified causes**



*Those final numbers do indeed match the earlier 3500 kill claim*

*But how does this compare with, for instance, wind energy?*

Kill numbers should first be adjusted for the corresponding powers produced:

An earlier wind power bird kill study extrapolated 573,000 total U.S. bird kills <sup>1</sup>

That extrapolation was for 2012 total U.S. wind power capacity of 51,630 MW

**Wind power bird kill rate = (573 K) / (51,630 MW) = 11.1 / MW / yr**

Ivanpah's design capacity is given as 377 MW, but its study notes that:

"The three solar units became operational at different times during the winter 2013-2014"

And elsewhere Ivanpah's 1<sup>st</sup> year power level is reported as 40%, I thus estimate:

**Ivanpah's bird kill rate ~ 3504 / (0.4)(377 MW) ~ 23.2 / MW / yr**

Thus yielding roughly comparable bird kill rates

With, possibly, lower kill rates for raptors/bats less common out in flat dessert?

1) That wind turbine bird kill study is discussed (and analyzed) in my note set: *Wind Power - Part II* ([pptx](#) / [pdf](#) / [key](#))

# Finally: Data on ALL human-caused U.S. bird kills

This from the "State of the Birds" organization's 2014 annual report:

Cause:	Annual U.S. Bird Kills:
<b>Domestic Cats</b>	<b>2400 million</b>
<b>Building Collisions</b>	<b>599 million</b>
<b>Auto Collisions</b>	<b>200 million</b>
<b>Power Line Collisions</b>	<b>25 million</b>
<b>Telecom Tower Collisions</b>	<b>6.6 million</b>
<b>Power Line Electrocutions</b>	<b>5.6 million</b>
<b>Agricultural Chemicals</b>	(No data given)
<b>Wind Turbines</b>	<b>0.234 million</b>
<b>Solar Thermal Plants</b>	(No data given)

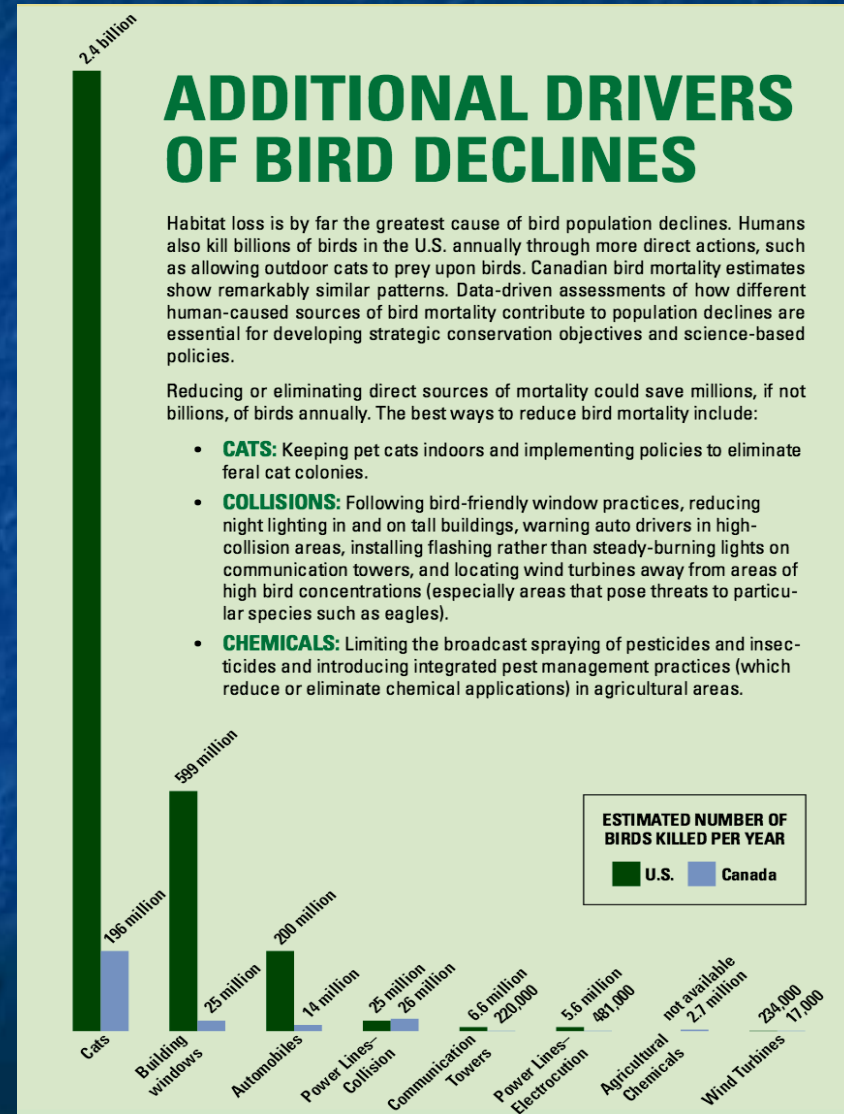

Figure from: [http://www.stateofthebirds.org/2014%20SotB\\_FINAL\\_low-res.pdf](http://www.stateofthebirds.org/2014%20SotB_FINAL_low-res.pdf)  
 It incorporates data (some then unpublished) these studies of Loss et al.:  
 2012: <http://www.nature.com/ncomms/journal/v4/n1/full/ncomms2380.html>  
 2015: <http://www.annualreviews.org/doi/abs/10.1146/annurev-ecolsys-112414-054133?journalCode=ecolsys>

*From the preceding two slides:*

Plus the fact that time-averaged power consumption per U.S. household = 1.25 KW <sup>1</sup>

**IF 100% of my household's power were provided by Wind Power,**

my household's share of wind turbine bird kills would be

$$(11.1 / \text{MW} / \text{yr}) \times 1.25 \text{ KW} = \mathbf{0.014 \text{ bird kills} / \text{yr}}$$

**IF 100% of my household's power were provided by Tower Solar Thermal Power,**

my household's share of Tower Solar Thermal bird kills would be

$$(23.2 / \text{MW} / \text{yr}) \times 1.25 \text{ KW} = \mathbf{0.029 \text{ bird kills} / \text{yr}}$$

IF there are ~100 million U.S. households, half including **cats**,

then my household is one of 50 million households including cats making

$$\text{my share of cat bird kills } 2400 \text{ million} / 50 \text{ million} = \mathbf{48 \text{ bird kills} / \text{yr}}$$

My cats are not "free-range" so I'll claim a lesser responsibility - but you get the point

1) As discussed in my note set: U.S. Energy Production and Consumption ([pptx](#) / [pdf](#) / [key](#)),

Original source: U.S. Energy Information Agency FAQs 2017: <https://www.eia.gov/tools/faqs/faq.php?id=97&t=3>

# *Credits / Acknowledgements*

Some materials used in this class were developed under a National Science Foundation "Research Initiation Grant in Engineering Education" (RIGEE).

Other materials, including the WeCanFigureThisOut.org "Virtual Lab" science education website, were developed under even earlier NSF "Course, Curriculum and Laboratory Improvement" (CCLI) and "Nanoscience Undergraduate Education" (NUE) awards.

This set of notes was authored by John C. Bean who also created all figures not explicitly credited above.

Copyright John C. Bean

(However, permission is granted for use by individual instructors in non-profit academic institutions)