

John's Tutorial on Everyday Mathcad (Version 9/2/09)

Mathcad isn't: Mathcad is not the specialist's ultimate mathematical simulator

Applied mathematicians may prefer the power of *Mathematica*

Complex programs may be easier in *Matlab*

Finite element analysis of materials is better suited to *ANSYS*

Mathcad is: 1) A user-friendly *scratchpad* for calculations too complex for the calculator, but not complex enough to justify a custom program

2) A medium for **communicating** calculations to others because it reads like normal math

In industry I found Mathematica, Mathlab, ANSYS were used by specialists,

Mathcad was used by almost everyone!

Further, it was how we shared our results (in memos, at meetings...)

WYSIWYG (what you see is what you get): This is Mathcad's great strength

There are no hidden programming steps or cell definitions (as in Matlab or Excel).

Math in a Mathcad worksheet page looks 98% the same as it would in the textbook.

UNITS: A HUGE strength of Mathcad is that it can calculate with units!!!

Why strength? If you enter an equation wrong, you can spot your error!

EXAMPLE: From high school physics, know that distance traveled by accelerating object is

$$d = v \cdot t + \frac{1}{2} a \cdot t^2$$

Let's say I did calculation where I forgot to square t:

$$v := 2 \quad a := 3 \quad t := 4 \quad (\text{What's the squiggly green line? click on it to find out!})$$

$$d := v \cdot t + \frac{1}{2} \cdot a \cdot t \quad \text{and ask Mathcad to calculate: } d = 14$$

No problemo! Except that it's wrong! Try again giving everything units:

$$v := 2 \cdot \frac{\text{m}}{\text{s}} \quad a := 3 \cdot \frac{\text{m}}{\text{s}^2} \quad t := 4\text{s}$$

$$d := v \cdot t + \frac{1}{2} \cdot a \cdot t$$

As you type $1/2 \cdot a \cdot t$, it turns red ($v \cdot t$ and $1/2 \cdot a \cdot t$ have different units!!)

Click on equation: Tells you about a units mismatch between terms!

Would also smell a rat if screwed up simpler equation for constant velocity $d = v \cdot t$

$$d := v \cdot t^2 \quad d = 32 \text{ m} \cdot \text{s} \quad \text{Distance does not have the units of meters * seconds!}$$

How to enter units? Mathcad just treats them as constants

Many are built into Mathcad and with use you will learn Mathcad's symbols

To start with use menu: [Insert / Unit](#)

Then select dimension to get suitable alternate units

OR go straight to list of units

Finally click insert

WARNING: Mathcad units are represented by same letters that you may use for variables

If you assign value to letter that is also used for unit, your entry will overwrite it

EXAMPLE: Built in unit of acceleration of gravity, "g"

$g = 9.807 \frac{\text{m}}{\text{s}^2}$ Right! but now let me use g for something else

$\underline{v} := 1 \frac{\text{m}}{\text{s}}$ $\underline{t} := 1\text{s}$ $\underline{g} := v \cdot t$

Then $g = 1 \text{ m}$ Which IS the result of my calculation - but I've lost the built-in unit

The squiggly green underlines are Mathcad warning you of potential overwriting!

- SOLUTIONS:
- 1) Use longer names for your variables (that are unlikely to coincide with units) OR
 - 2) Test first by just typing your letter and = It should not already have a value:

$q :=$  Mathcad can't figure out what q is - so it must not be using it as a unit

CHANGING UNITS: For instance what if Mathcad computes in meters per second and you want cm/s?

$$\underset{\text{m}}{d} := 1\text{m} \qquad \underset{\text{s}}{t} := 1\text{s} \qquad \underset{\text{m}}{v} := \frac{d}{t}$$

type "v=", then click on right side of equation. Mathcad types 1 m/s (box) $v = 1 \frac{\text{m}}{\text{s}}$

The box is Mathcad's invitation to plug in your units:

Enter something in box, Mathcad leaves it but divides rest of eqn by what you typed

(in essence, Mathcad is factoring out what you entered) - try above

TEXT: If want to write a comment (to label or explain your work), start by typing a quotation mark "

OR

If what you are typing makes no sense as an equation, Mathcad will change to text

This happens when you enter a space (which should not appear in equation)

TEXT with EQUATIONS: Can insert an equation within text by menu: [Insert / Math Region](#)

FORMATTING: Colors, boxes... right click mouse and make selection

ALL THAT IS LEFT is how to enter those strange math symbols missing from PC keyboard!

There are shortcut keys that you will gradually learn. Some I use a lot:

In Text and Equations: Greek character: cursor after character, then type ctrl+G

In Equations only:

Square root: type \

Exponent: type ^

Not equal: type ctrl+3

Infinity: type control+shift+Z

Prime: cursor after character, type ctrl+F7

Inactive Subscript (just label): cursor after character, "." (period), type subscript

Active Subscript (index): cursor after character, [, type subscript

Vector (arrow over character): cursor after character, ctrl+"_"

However, to start with, just go to [View / Toolbars](#) and select a whole lot of types.

Leave the tool bars you need open (just park them off to the side of your workspace)

Do this now for "Calculus" "Greek" and "Matrix" menus

FUNCTIONS: Just type normally (but using Mathcad's =: sign)

$$f(y) := y^2 \qquad g(y) := \cos(y)$$

Value at a given point? Just type function with value of y you want followed by = $f(2) = 4$

PLOT OF FUNCTION(s):

keyboard action:

- Type menu: [Insert / Graph / X-Y Plot](#)
(blank plot with two small boxes appears)

- type y in bottom box
- type f(y) in left box

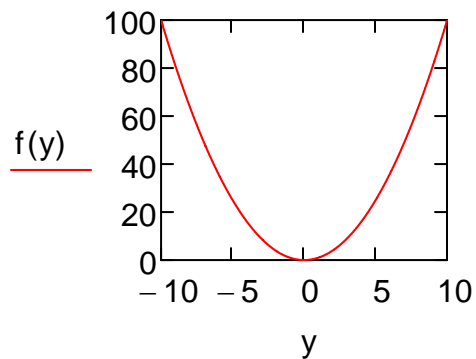

What if don't see any plot (!^#\$^%)
or is plotted over range I don't want?

FORCING PLOT LIMITS:

keyboard actions:

- Enter new plot (or cut and paste one above)
- Click on plot

(Mathcad displays limits it chose for each axis)

- Change any limit you want

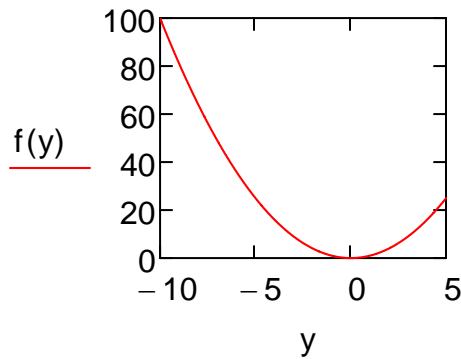

PLOT OF MULTIPLE FUNCTIONS:

keyboard actions:

- Cut and paste simple plot from above
- Click on function at left
- Get cursor to end of function
- type "," (comma)

(Mathcad produces new box)

- Type in second function

(repeat as many times as want)

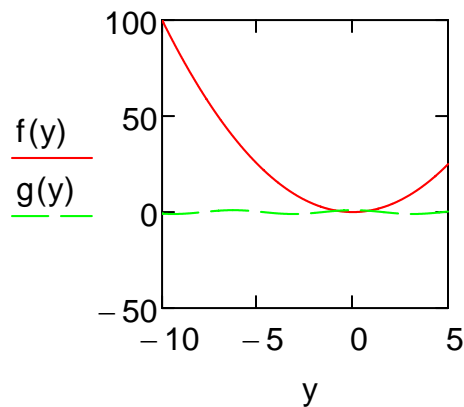

To change lines or colors:

- Double click on plot
- Click on "Traces" tab
- Change the "trace" (line) you want

2D PLOTS:

keyboard actions:

- Define 2D function

$$h(x, y) := x^2 + y^2$$

- Type menu Insert / Graph / Surface Plot
- Type function (with no arguments!) into box

OR

- Type menu Insert / Graph / Contour Plot
- Type function (with no arguments!) into box

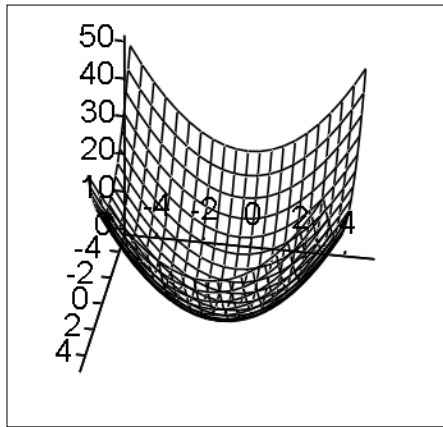

h

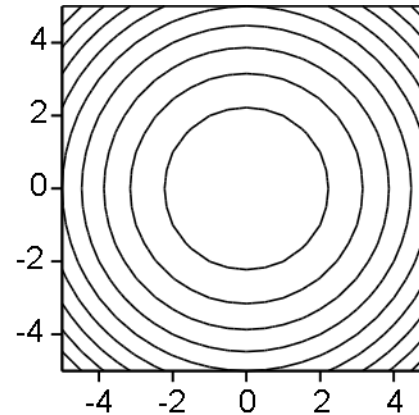

h

Double click on plots to format colors, shading ...

Above is enough Mathcad for my classes! If you are new to Mathcad you might want to stop here!

Above is all the Mathcad I regularly use and know!

Below is only for fun or for possible use in other classes!!

ANIMATION OF PLOT: What if have function varying with x and time - how best to plot?

Could just do a 2D plot: $\kappa := 0.5$ $\omega := 0.5$ $f(x, t) := \cos(\kappa \cdot x - \omega \cdot t)$ then do as above:

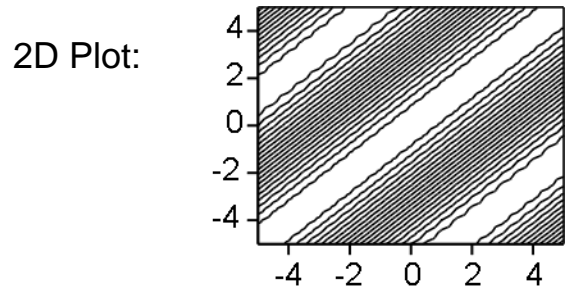

OK, the information IS all there: Increasing x horizontal
Increasing t vertically

But do you really SEE how is changing with time?

f

Or ANIMATE the time variable by setting it equal to a built in variable called FRAME

$\kappa := 0.5$ $\omega := 0.5$ $\tau := \text{FRAME}$ $g(\chi, \tau) := \cos(\kappa \cdot \chi - \omega \cdot \tau)$

Then insert a simple X-Y Plot - with χ as the variable:

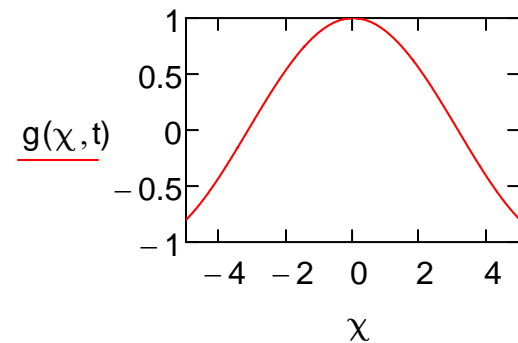

- To animate:
- Click menu: [Tools / Animation / Record](#)
 - While pop-up is there, select the input data, equations and plot with your mouse
 - Then click Animate

(Can tweak number of frames, speed and movie save options in the pop-up)

SOLVE - Very useful. Very dangerous (easy to get wrong answers, I ban its use on my tests!):

i) Type an equation you want to solve, but use the bold "statement" equal sign (typed as control =):

$$q + 1 = 0$$

ii) Select an instance of the variable you want to solve for (here it is q)

iii) Go to menus "Symbolics" => "Variable" => "Solve" (commands differ slightly w/ Mathcad version)

iii) Mathcad types out the value it got for p (which I have moved to right): -1

Works fine, what's the problem? Try to solve another more complex equation

$$0.5 \sin(p) + 0.51 - 0.001p = 0$$

Plot to see what this function is really like:

It's a sine, raised, but then tilted very slightly downward to the right so that it actually first falls through 0 at about $p = 12$.

$$0.5 \sin(p) + 0.51 - 0.001p$$

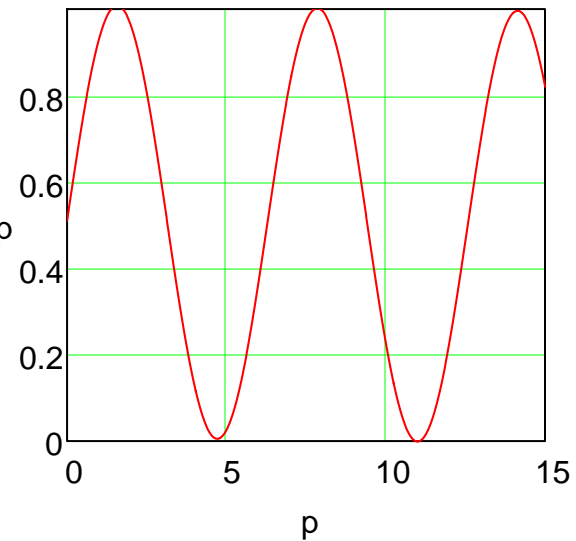

Apply Mathcad's solve tool to the equation to get p:

$$4.7143819625524642837 + .14529048952397780536 \cdot i$$

What the heck! It is a value near 5 and it is imaginary (!#%@%!*&%)

I fooled Mathcad! The function ALMOST passed through zero near $p = 5$

Mathcad tries to minimize the discrepancy between left and right sides of equation.

But it uses **finite math** so it doesn't drive the error to exactly zero

Thus a near miss can be misjudged as an intersection!

ALSO, even if there are multiple true intersections, it may only give one or a subset,

May not be the one(s) you need!!

Solve tools regularly screw up students in my advanced classes (including on final exams!).

ADVICE: Understand your functions well AND/OR also plot them out as insurance!

Mathcad you might use in first year calculus:

VALUE OF A DEFINITE INTEGRAL: keyboard actions:

$$\int_1^2 \cos(x) dx = 0.068$$

- Click definite integral in pop-up menu
- Fill in limits, expression, and differential
- Type = for answer

VALUE OF A DERIVATIVE: keyboard actions:

$$x := 3$$

$$\frac{d^2}{dx^2} \cos(x) = 0.99$$

- Type value of x where is to be evaluated
- Move to new line
- Click a derivative in pop-up menu
- Fill in differential and function
- Type = for answer

"SYMBOLIC" INTEGRATION: keyboard actions:

$$\int_m^n x^2 dx \rightarrow \frac{n^3}{3} - \frac{m^3}{3}$$

- Click definite integral in pop-up menu
- Fill in limits, expression and differential
- Type ctrl + "." (to get the arrow)
- Click away from equation

NOTE: Mathcad has trouble with complex integrals (especially with trig integrals, sorry)

"SYMBOLIC" DIFFERENTIATION: keyboard actions:

$$\frac{d^2}{dz^2} (z \cdot \cos(z)) \rightarrow -2 \cdot \sin(z) - z \cdot \cos(z)$$

- Click derivative in pop-up menu
- Fill in derivative and function
- Type ctrl + "." (to get the arrow)
- Click away from equation

NOTE: In this lecture, I have to keep changing variables because otherwise Mathcad is reading specific values from earlier in lecture - and thus does not treat them as variable!

MULTIPLY MATRICES keyboard actions:

$$\begin{pmatrix} 1 & 2 & 3 \\ 4 & 5 & 6 \\ 7 & 8 & 9 \end{pmatrix} \cdot \begin{pmatrix} 10 \\ 11 \\ 12 \end{pmatrix} = \begin{pmatrix} 68 \\ 167 \\ 266 \end{pmatrix}$$

- Click matrix symbol in matrix pop-up menu
- Provide dimensions of matrix (here 3 rows x 3 columns)
- Fill in matrix (with numbers or symbols)
- Hit space bar until whole matrix is selected
- Type shift + * (to multiply)
- Click on box and enter a 1 x 3 matrix
- Type space bar until whole matrix is selected
- Type =

INVERT A MATRIX keyboard action:

- Enter a 3x3 matrix (as above or just cut and paste)
- Hit space bar until whole matrix is selected
- Type ^ (for exponential)
- Type -1 (for inverse)

(Then tinker with matrix until find one that has inverse! I changed center # to 19)

$$\begin{pmatrix} 1 & 2 & 3 \\ 4 & 19 & 6 \\ 7 & 8 & 9 \end{pmatrix}^{-1} = \begin{pmatrix} -0.732 & -0.036 & 0.268 \\ -0.036 & 0.071 & -0.036 \\ 0.601 & -0.036 & -0.065 \end{pmatrix}$$

FINAL WARNING:

Mathcad can become unstable and crash

It can also freak out with certain mice and lock-up

Save at least once per page typed !!!!

